

FTB-2/FTB-2 Pro and FTB-4 Pro



Copyright © 2014–2017 EXFO Inc. All rights reserved. No part of this publication may be reproduced, stored in a retrieval system or transmitted in any form, be it electronically, mechanically, or by any other means such as photocopying, recording or otherwise, without the prior written permission of EXFO Inc. (EXFO).

Information provided by EXFO is believed to be accurate and reliable. However, no responsibility is assumed by EXFO for its use nor for any infringements of patents or other rights of third parties that may result from its use. No license is granted by implication or otherwise under any patent rights of EXFO.

EXFO's Commerce And Government Entities (CAGE) code under the North Atlantic Treaty Organization (NATO) is 0L8C3.

The information contained in this publication is subject to change without notice.

Trademarks

EXFO's trademarks have been identified as such. However, the presence or absence of such identification does not affect the legal status of any trademark.

Units of Measurement

Units of measurement in this publication conform to SI standards and practices.

Patents

Feature(s) of this product is/are protected by one or more of: a pending US design patent and equivalent(s) in other countries; and US design patents D739,277 and D763,713 and equivalent(s) in other countries.

Version number: 2.0.1.4

Contents

Certification Information	viii
1 Introducing the FTB-2/FTB-2 Pro and FTB-4 Pro	1
Main Features	1
Working With FTB and FTBx Modules	10
LED Indicators Description	13
Function Buttons Description	16
Power Sources	17
Automatic Fan Speed Management	19
Software Options for Your Unit	20
Product Registration	21
Technical Specifications	21
Conventions	22
2 Safety Information	23
Other Safety Symbols on Your Unit	25
Laser Safety Information	26
Electrical Safety Information	27

Contents

3 Getting Started with Your Unit	33
Grounding Your Unit	33
Positioning Your Unit	35
Installing the Carry Handle	36
Installing the Shoulder Strap	39
Installing or Removing FTB Module Adapters	40
Inserting and Removing Test Modules	45
Turning On Your Unit	57
Turning Off Your Unit	57
Configuring Your Unit At First Startup	63
Accessing and Exiting ToolBox X	65
Starting Module Applications	66
Using the On-Screen (Virtual) Keyboard	67
Working with Windows 8.1 Pro or Windows Embedded 8 Standard	68
Right-Clicking with the Touchscreen	70
Installing or Upgrading the Applications	71
Activating Software Options	74
Installing Third-Party Software on Your Unit	77
Protecting your Unit with an Antivirus Software	77
Securing your Unit Using the Kensington Lock	78
Using a Keyboard, Mouse or Other USB Devices	79
Working with Bluetooth Devices	81
4 Setting Up Your Unit	83
Adjusting Brightness	83
Adjusting Microphone and Speaker Volume	85
Recalibrating the Touchscreen	91
Customizing the Right-Click Feature	94
Enabling or Disabling the Automatic Logon	98
Selecting the Startup Applications	102
Configuring Network Printers	104
Selecting the Language of Operation	106
Setting Date and Time Formats	117
Adjusting the Date, Time and Time Zone	119
Configuring the Power Management Options	122
Setting ToolBox X Behavior	132
Configuring the Internet Options	134
Getting Ready to Retrieve Geolocation Information	137
Configuring Parameters via Windows Mobility Center	142
Setting Other Parameters	143

5 Working with Your Unit	145
Printing Documents	145
Viewing PDF Files	146
Taking Screen Captures	147
Browsing the Web	148
Accessing the Internet with a Mobile Broadband USB Modem Key	149
Retrieving the GPS Location of Your Unit	151
Managing Favorites	154
Using the Calculator	162
Using the Text Editor	162
Accessing Other Tools	163
6 Using the Optional Built-In Power Meter and VFL	165
7 Inspecting Fibers with a Probe	167
8 Managing Data	169
Viewing Disk Space and Managing Files	170
Transferring Data Using the Bluetooth Technology	171
Connecting to a Wireless Network	178
Using the USB to RS-232 Adapter	181
Freeing Up Disk Space with the Disk Cleanup Utility	187
Enabling or Disabling the Wireless Communication	191
Connecting to a VPN from Your Unit	196
9 Accessing Your Unit Remotely	203
Working with Remote Desktop	204
Working With VNC	214
Adding Exceptions to the Firewall	222
10 Testing Network Connections	227
Performing a Ping Test	227
Performing a Trace Route Test	230
Exporting the Results	232
11 Preparing for Automation	233
Linking Units with the Ethernet Port	235
Linking Units Using a Serial Port	235
Getting Optimum Performance from Your Unit	236
Changing Communication Settings	238
Configuring DCOM Access to Your Unit	243
Configuring Your Instruments	266

Contents

12 Using Your Unit and Modules in an Automated Test Environment	275
Standard Status Data Structure	276
SCPI Command Structure	280
Consulting Data Types	283
Writing Remote Control Code	284
Error Message Format	286
Monitoring Remote Commands	287
13 Maintenance	291
Cleaning Detector Ports	292
Cleaning VFL-Type Connectors	293
Cleaning the Touchscreen	294
Recharging the Batteries	295
Modifying the Low-Battery Thresholds	298
Replacing Batteries	303
Installing or Removing the Power Meter and VFL	309
Managing Windows Updates	316
Replacing Fuses (FTB-4 Pro Only)	321
Recycling and Disposal	322
14 Troubleshooting	323
Solving Common Problems	323
Restoring Your Unit to Normal Operation	332
Accessing the Online Documentation	367
Contacting the Technical Support Group	368
Viewing System Information	369
Retrieving Network Interfaces Information	372
Transportation	376
15 Warranty	377
General Information	377
Liability	378
Exclusions	378
Certification	378
Service and Repairs	379
EXFO Service Centers Worldwide	380
A Data Types	381
Applicable Data Types for Input—IEEE 488.2	382
Applicable Data Types for Output —IEEE 488.2	391
Applicable Data Types for Input—SCPI	401
Special Numeric Values Received on Output	402

B IEEE 488.2 and Specific Command Reference	403
IEEE 488.2 Commands—Quick Reference	403
IEEE 488.2 Required Commands	404
Specific Commands—Quick Reference	424
Specific Commands	425
C SCPI-Based Errors	443
D COM Properties and Events	459
ActiveX (COM/DCOM)—Quick Reference	460
Properties	461
Events	468
E Communicating Through TCP/IP Over Telnet	469
Executing SCPI Commands Over Telnet	469
Accessing Modules	475
Internal Commands of the TCP/IP over Telnet Protocol	477
Index	489

Certification Information

North America Regulatory Statement

This unit was certified by an agency approved in both Canada and the United States of America. It has been evaluated according to applicable North American approved standards for product safety for use in Canada and the United States.

Electronic test and measurement equipment is exempt from FCC part 15, subpart B compliance in the United States of America and from ICES-003 compliance in Canada. However, EXFO Inc. makes reasonable efforts to ensure compliance to the applicable standards.

The limits set by these standards are designed to provide reasonable protection against harmful interference when the equipment is operated in a commercial environment. This equipment generates, uses, and can radiate radio frequency energy and, if not installed and used in accordance with the user guide, may cause harmful interference to radio communications. Operation of this equipment in a residential area is likely to cause harmful interference in which case the user will be required to correct the interference at his own expense.

Modifications not expressly approved by the manufacturer could void the user's authority to operate the equipment.

Note: *Information such as the FCC and IC numbers is available directly from ToolBox X. From the button bar, tap , and then select the **Platform** tab. The numbers are listed under **Regulatory information**.*

Your unit comes with an internal wireless module and antenna for which the following information applies:

- This equipment has been tested and found to comply with the limits for a Class A digital device, pursuant to Part 15 of the FCC Rules.
- This device complies with Industry Canada license-exempt RSS standard(s). Operation is subject to the following two conditions: (1) This device may not cause harmful interference, and (2) this device must accept any interference received, including interference that may cause undesired operation.
- This device complies with the US/Canada portable RF exposure limit set forth for an uncontrolled environment and is safe for intended operation as described in this user documentation. The further RF exposure reduction can be achieved if the device can be kept as far as possible from the user's body.
- This device does not contain any user-serviceable components. Any unauthorized product changes or modifications will invalidate warranty and all applicable regulatory certifications and approvals.

Note: *You will only be able to work with Wi-Fi and Bluetooth® if you have purchased the RF option.*

European Community Declaration of Conformity

Warning: This is a class A product. In a domestic environment, this product may cause radio interference in which case the user may be required to take adequate measures.

Hereby, EXFO declares that the radio equipment type “Wideband Data Transmission” is in compliance with European Directive 2014/53/EU.

The full text of the EU declaration of conformity is available at the following Internet address: *www.exfo.com/library*.

The information about the Bluetooth® and Wi-Fi frequency bands is as follows:

- Bluetooth®: Between the frequencies 2400.0 MHz - 2483.5 MHz.
The output power is 4.0 dBm typical.
- Wi-Fi: Between the frequencies 2400.0 MHz - 2483.5 MHz.
The maximum output power is 16.0 dBm.
- Wi-Fi: Between the frequencies 5150.0 MHz - 5825.0 MHz.
The maximum output power is 12.0 dBm.

This device is a 2.4 GHz and 5 GHz wideband transmission system (transceiver), intended for use in all EU member states and EFTA countries, except in France and Italy where restrictive use applies.

In Italy, the end-user should apply for a license at the national spectrum authorities in order to obtain authorization to use the device for setting up outdoor radio links and/or for supplying access to telecommunications and/or network services.

This device may not be used for setting up radio links in France, and in some areas the RF output power may be limited to 10 mW EIRP in the frequency range of 2454 - 2483.5 MHz. For detailed information, the end-user should contact the national spectrum authority in France.

1 Introducing the FTB-2/FTB-2 Pro and FTB-4 Pro

Note: *In this documentation, the words “tap” and “double-tap” (related to the use of a touchscreen) replace the words “click” and “double-click”.*

Note: *Many of the illustrations of the unit itself show a two-slot model. Unless otherwise specified, the information applies to the four-slot model (FTB-4 Pro) as well.*

Note: *Depending on the version of operating system that your unit is running, the appearance of the applications may vary slightly from the illustrations presented in this documentation.*

Main Features

Your unit includes the following:

- 10.1-inch color touchscreen (LCD and touchscreen optimized for outdoor use available as an option)
- Two USB 2.0 host ports and one USB 3.0 host port
- Ethernet port (10/100/1000 Base-T)
- Headset/microphone port (for headsets equipped with a microphone)
- External monitor port (for monitors with DisplayPort interface)
- Optional Wi-Fi and Bluetooth capability
- Optional built-in power meter and VFL

Introducing the FTB-2/FTB-2 Pro and FTB-4 Pro

Main Features

- Main stream operating system:
 - FTB-2: Windows 10 IoT Enterprise or Windows Embedded 8 Standard, depending on the time of purchase of your unit. Units running Windows Embedded 8 Standard can be upgraded to Windows 10 IoT Enterprise by purchasing a license from EXFO.
 - FTB-2 Pro: Windows 10 IoT Enterprise or Windows 8.1 Pro, depending on the time of purchase of your unit. Units running Windows 8.1 Pro can be upgraded to Windows 10 IoT Enterprise by purchasing a license from EXFO.
 - FTB-4 Pro: Windows 10 IoT Enterprise
- Multitasking possibilities
- Remote access to your unit (via VNC or Remote Desktop)
- Modules and instruments can be controlled locally via the ToolBox X software or remotely through RS-232 or Ethernet TCP/IP (using SCPI commands).
- Direct Web access from your unit
- Possibility to take screen captures
- PDF file viewer available from your unit
- Easy transfer of files and folders to an external storage device
- Easy software updates

Introducing the FTB-2/FTB-2 Pro and FTB-4 Pro

Main Features

Front

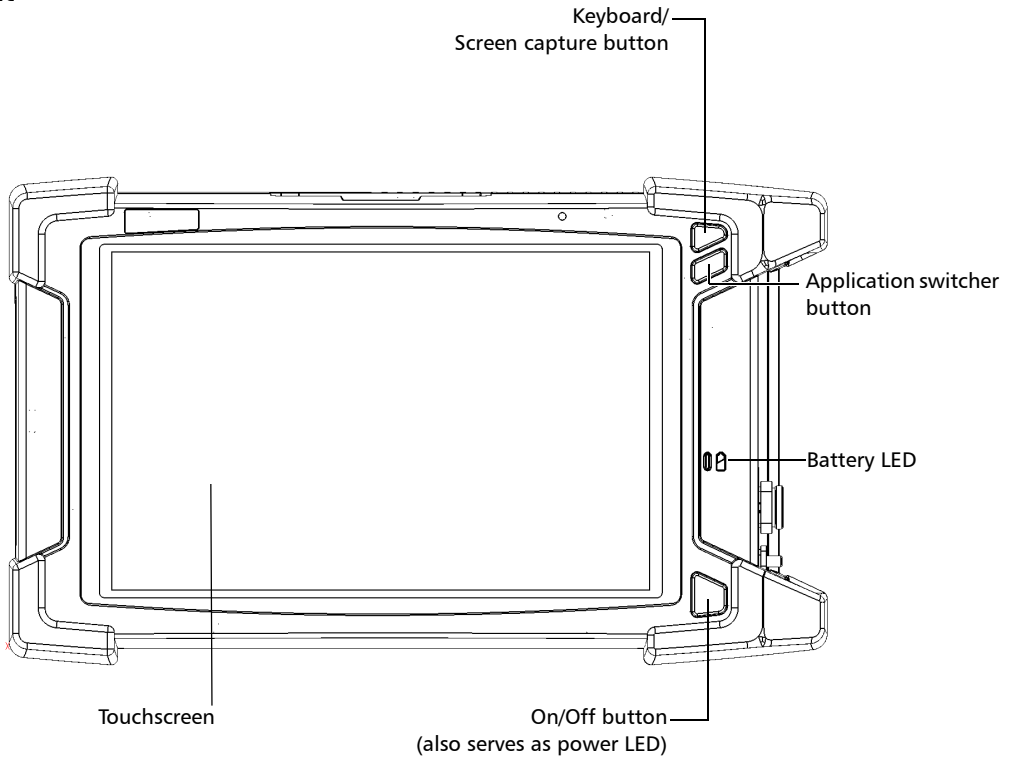

Introducing the FTB-2/FTB-2 Pro and FTB-4 Pro

Main Features

Right panel

(Two-slot model)

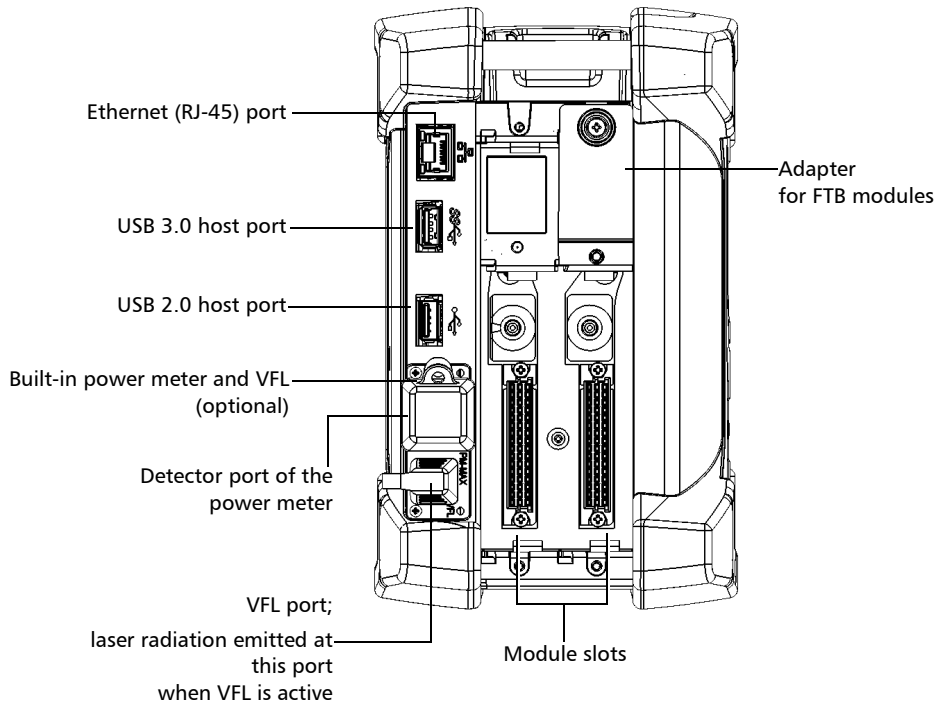

Right panel (Four-slot model)

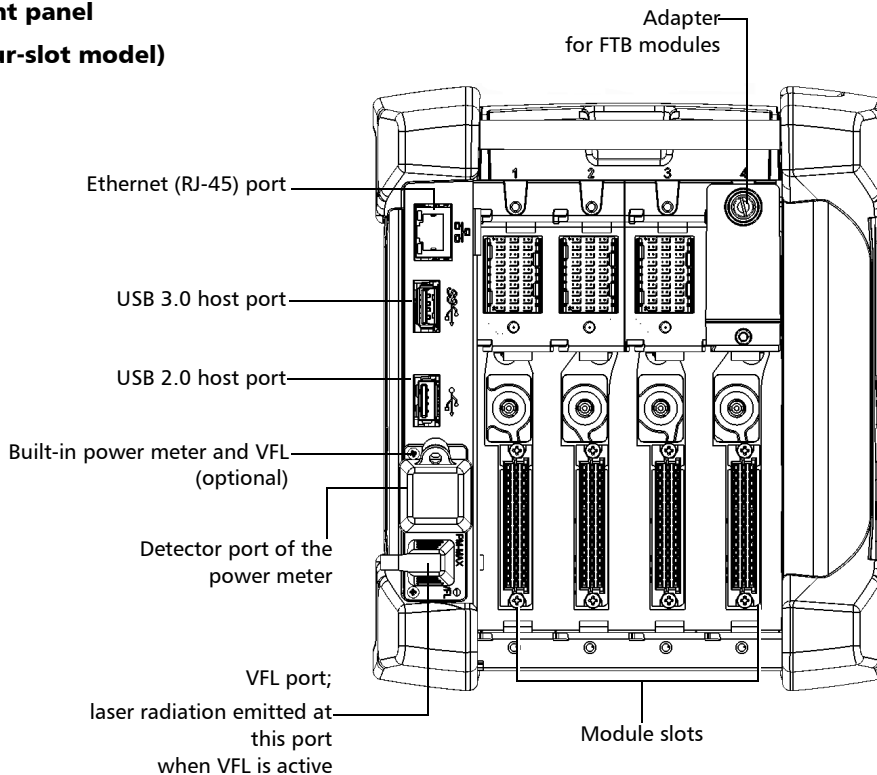

Introducing the FTB-2/FTB-2 Pro and FTB-4 Pro

Main Features

Left panel

(Two-slot model)

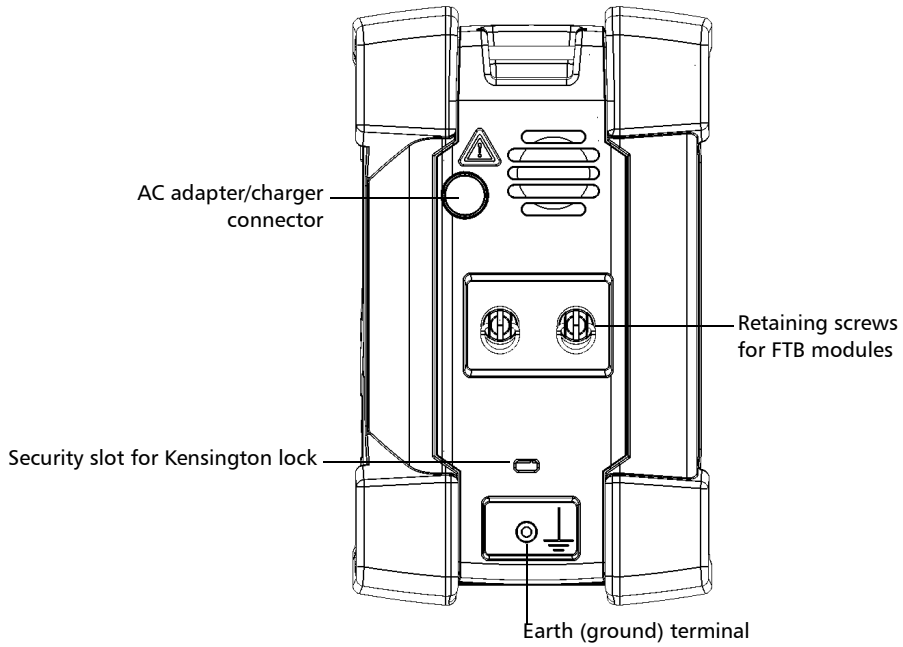

Left panel (Four-slot model)

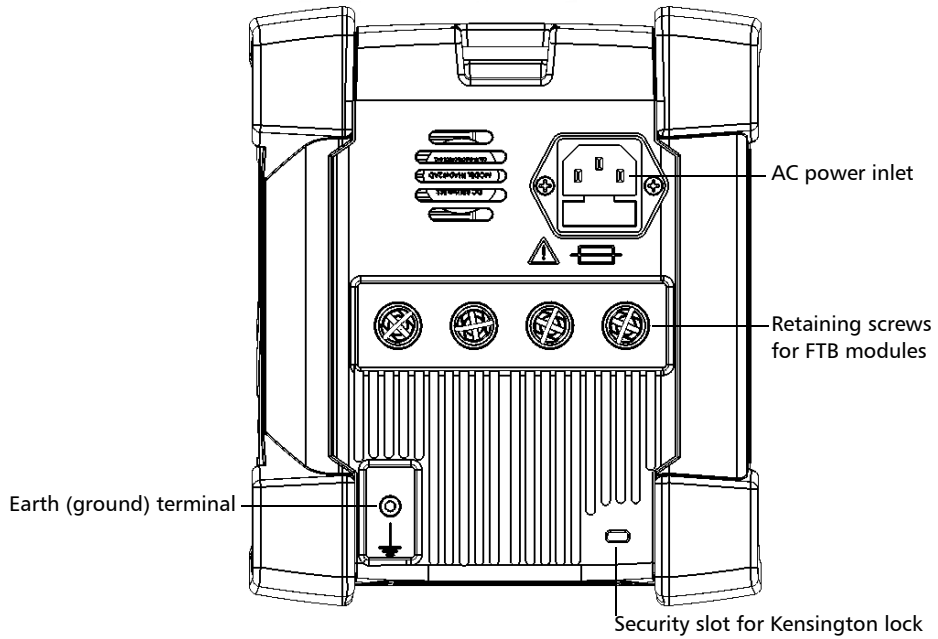

Introducing the FTB-2/FTB-2 Pro and FTB-4 Pro

Main Features

Top

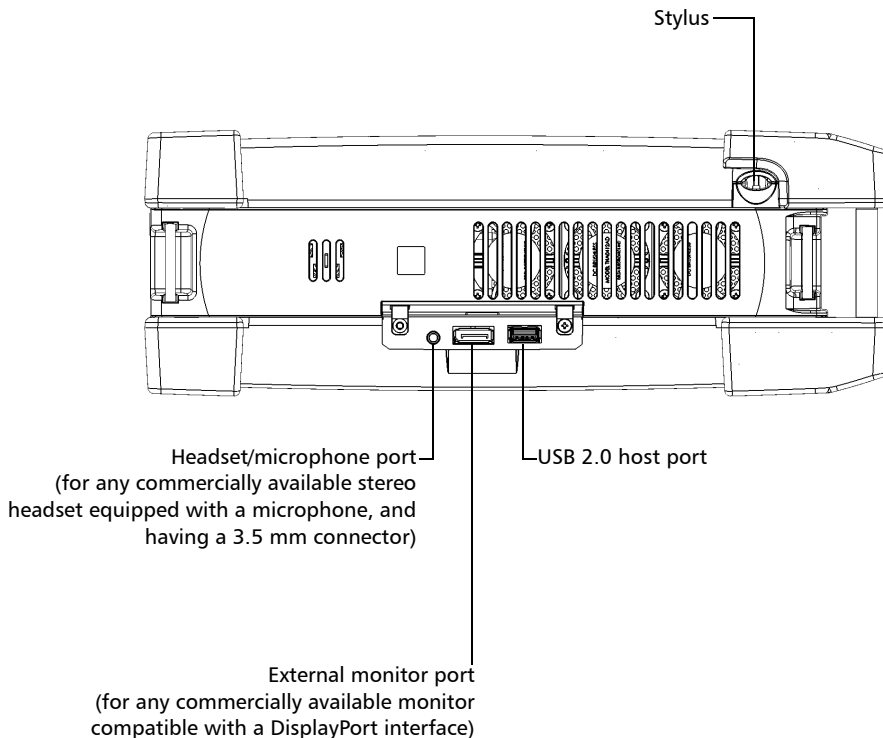

Introducing the FTB-2/FTB-2 Pro and FTB-4 Pro

Main Features

Back

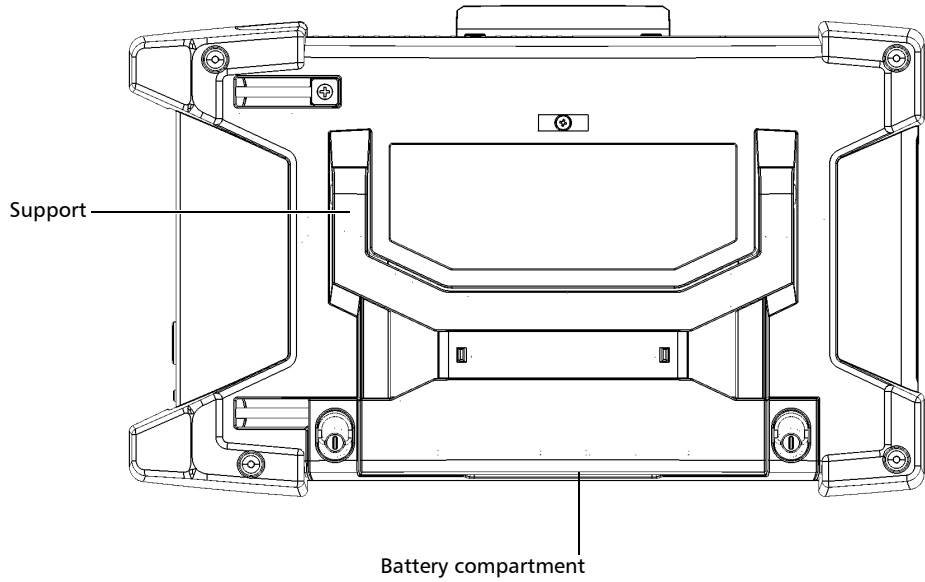

Introducing the FTB-2/FTB-2 Pro and FTB-4 Pro

Working With FTB and FTBx Modules

Working With FTB and FTBx Modules

You can insert FTBx modules, FTB modules, or a combination of both in your unit.



CAUTION

Your unit is compatible with some of the FTBx modules and some of the FTB modules. For a list of supported modules, refer to your unit's technical specifications. To avoid damaging your unit, use it only with modules approved by EXFO.

The type of modules (FTBx or FTB) is indicated on the front panel of the module, on the identification sticker affixed to its side, or on both.

However, since the two types of modules have very different heights and lengths, you can also identify them just at a glance.

On the images below, the FTBx module is shown in dark gray.

Side

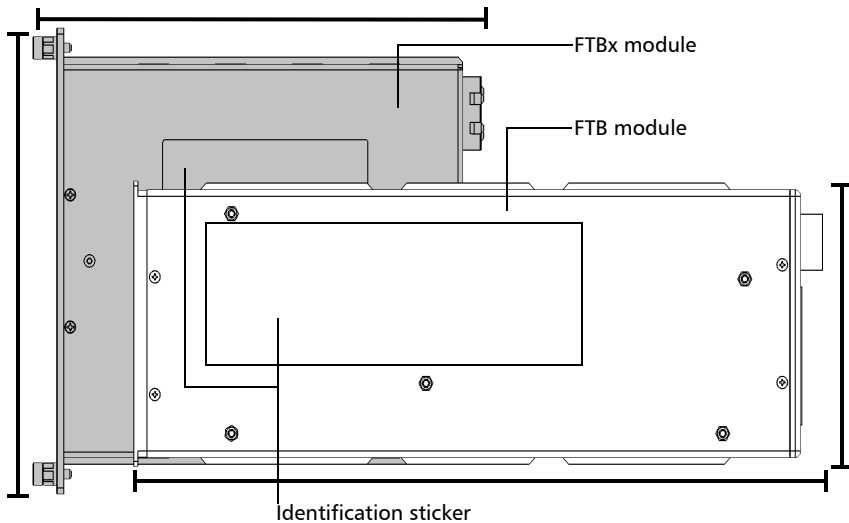

Introducing the FTB-2/FTB-2 Pro and FTB-4 Pro

Working With FTB and FTBx Modules

Front

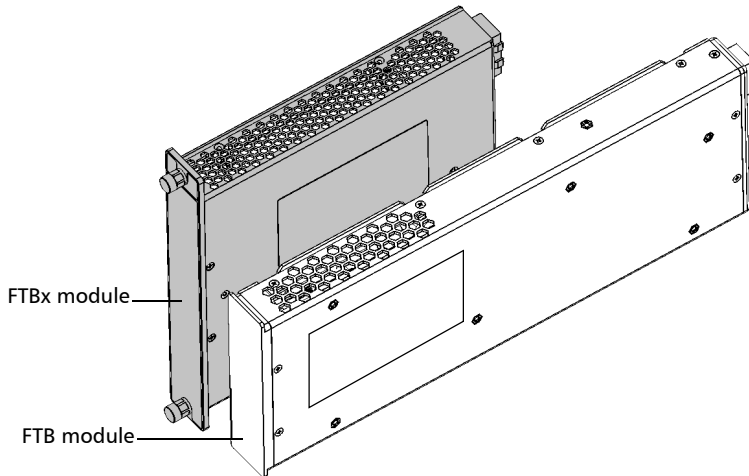

Back

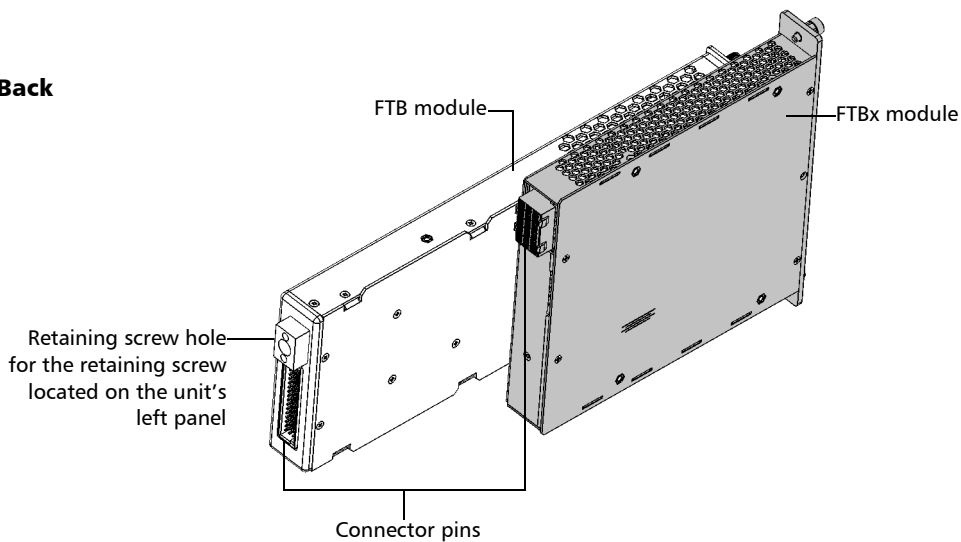

Introducing the FTB-2/FTB-2 Pro and FTB-4 Pro

Working With FTB and FTBx Modules

Because the two types of modules have different sizes, you need a module adapter to work with FTB modules if your unit is not already equipped with such adapters. The adapters must be removed before inserting FTBx modules.

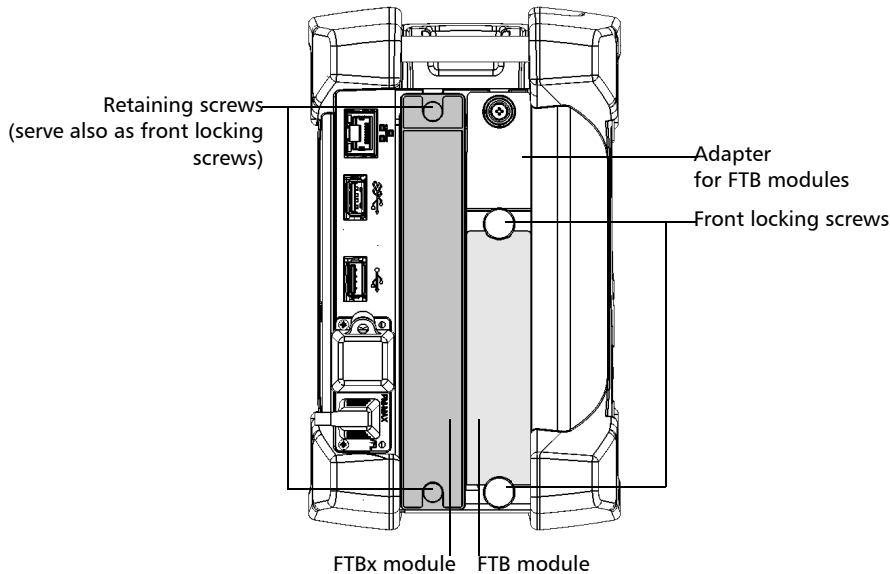

For more information on how to install or remove the adapters, see *Installing or Removing FTB Module Adapters* on page 40. For more information on how to insert or remove modules, see *Inserting and Removing Test Modules* on page 45.

LED Indicators Description

There are two LED indicators located on the front panel of your unit, providing you with information about the power and battery statuses.

LED	Status	Meaning
	Green	Unit is on.
	Green, blinking	Unit is in Sleep mode.
	Off	Unit is off or in Hibernation mode.
	Red	There is a major hardware problem with the unit. Contact EXFO.

Introducing the FTB-2/FTB-2 Pro and FTB-4 Pro

LED Indicators Description

LED	Status	Meaning
 (when unit is connected to an external power source)	Green	All batteries are fully charged.
	Green, blinking	At least one battery is charging.
	Yellow, blinking	The unit and its modules would be using more power than what is available from the batteries. Do not disconnect AC power while this module is in use. A blinking yellow LED takes precedence over a blinking green one, so when AC power is connected, even if the LED is blinking yellow, batteries are probably charging (depending on conditions).
	Red	Battery error. For more information, see <i>Solving Common Problems</i> on page 323.
	Red, blinking	The detected temperature is too high. This could lead to a thermal shutdown of the unit if no action is taken to reduce the temperature.
	Off	<ul style="list-style-type: none"> ➤ No battery present in the unit. ➤ The batteries in the unit are not charging. For more information, see <i>Solving Common Problems</i> on page 323.

Introducing the FTB-2/FTB-2 Pro and FTB-4 Pro

LED Indicators Description

LED	Status	Meaning
 (when unit is not connected to an external power source)	Off	The global level of the batteries is above the “low-battery threshold”.
	Yellow	The global level of batteries is low.
	Yellow, blinking	The unit and its modules would be using more power than what is available from the batteries. Connect AC power as soon as possible.
	Red, blinking	The detected temperature is too high. This could lead to a thermal shutdown of the unit if no action is taken to reduce the temperature.





Introducing the FTB-2/FTB-2 Pro and FTB-4 Pro

Function Buttons Description

Function Buttons Description

Your unit is equipped with function buttons that give you access to features at all times.

The table below shows an overview of their purpose.

Button	Meaning
	<ul style="list-style-type: none">▶ Displays the on-screen keyboard. Press once to show the keyboard. Press once again to hide it.▶ Takes a screen capture. Hold down for a few seconds.
	<p>Enables you to switch from one task to another. It is the equivalent of pressing the ALT + TAB key combination on a hardware keyboard, or tapping  from the taskbar in Windows 10.</p> <ul style="list-style-type: none">▶ Press once to view the list of running applications.▶ Press as many times as needed to select the desired application.
	<p>Turns your unit on and off.</p> <p>Press for one second to turn the unit on.</p> <p>For more information on the various ways to turn off your unit, see <i>Turning Off Your Unit</i> on page 57.</p>

Power Sources

Your unit operates with the following power sources:

- AC adapter/charger connected to standard power outlet (FTB-2 and FTB-2 Pro—indoor use only).

OR

Standard three-wire power cord connected to standard power outlet (FTB-4 Pro—indoor use only).

- Lithium-ion rechargeable batteries (the unit automatically switches to battery power if you disconnect it from its external power source). The unit can be used outdoors when it is powered by batteries.

When it is connected to an external power source, the unit will function even if the batteries are not present.

For all models, it is possible to switch from an external power source to battery power or vice versa without affecting operation, unless the battery LED () is yellow and blinking.

The batteries recharge automatically when the unit is connected to an external power source (with the AC adapter/charger or the three-wire power cord).

Introducing the FTB-2/FTB-2 Pro and FTB-4 Pro

Power Sources

The number of batteries that can power your unit and that come with it depends on the model that you have purchased. The table below gives detailed information

Model	Number of batteries that can power the unit
FTB-2	1 ^a
FTB-2 Pro	2
FTB-4 Pro	2

- a. Battery must be inserted in the first battery slot (use the markings at the back of the unit to guide you). The second battery slot does not power the unit. It only serves as storage for an extra battery that you would swap in the first battery slot when required.

Note: *When the ambient temperature is below 0 °C (32 °F) or when it reaches or exceeds about 40 °C, the batteries can either charge more slowly than usual, or not charge at all, depending on the internal temperature of your unit.*

For more information, see *Electrical Safety Information* on page 27.

Automatic Fan Speed Management

Your unit will determine the most appropriate fan speed, depending on the power requirements and the type of modules you are using.



IMPORTANT

Fan speed is always determined to cool down the most heat-generating modules.

If the temperature keeps rising and reaches the limit, your unit will turn off. This safety feature protects the unit and its modules against overheating.



CAUTION

Make sure to use protective covers over empty slots of your unit to avoid overheating.

Software Options for Your Unit

The following software options are offered for the platform itself.

Name of the Option	Description	FTB-2	FTB-2 Pro	FTB-4 Pro
IPT	Enables you to perform <i>ping</i> and <i>trace route</i> tests.	X	X	X
SMARTGPS	Enables you to retrieve geolocation information (latitude and longitude coordinates) from a smart device.	X	X	X
RF	Enables you to work with Wi-Fi and Bluetooth.	X	X	X
Automation	Enables you to perform automation tasks and use your unit in an automated test environment ^a .	X	-	-

a. The automation features are part of the applications delivered with the FTB-2 Pro and FTB-4 Pro units.

For more information on how to activate software options for your unit, see *Activating Software Options* on page 74.

For more information on the software options available for modules, test instruments, or dedicated applications, refer to the user documentation that comes with these products.

Product Registration

You can now register your new EXFO products either online or directly from your unit (if it is connected to the Internet), and benefit from every possible opportunity to optimize their performance. By doing so, you will always be notified of the latest software updates, key product enhancements and up-to-date support information related to your products.

To register your product directly from your unit:

1. Ensure that your unit can access the Internet.
2. From ToolBox X, tap **Utilities**, and then **Product Registration**.
3. Follow the on-screen instructions.

To register your product online:

1. Open a Web browser and go to *www.exfo.com*.
2. Log in to your EXFO account.
3. Tap **Support**.
4. Under **Tools**, tap **Manage My Products**.
5. Tap **Register**.
6. Follow the on-screen instructions.

Technical Specifications

To obtain this product's technical specifications, visit the EXFO Web site at *www.exfo.com*.

Conventions

Before using the product described in this guide, you should understand the following conventions:



WARNING

Indicates a potentially hazardous situation which, if not avoided, could result in *death or serious injury*. Do not proceed unless you understand and meet the required conditions.



CAUTION

Indicates a potentially hazardous situation which, if not avoided, may result in *minor or moderate injury*. Do not proceed unless you understand and meet the required conditions.



CAUTION

Indicates a potentially hazardous situation which, if not avoided, may result in *component damage*. Do not proceed unless you understand and meet the required conditions.



IMPORTANT

Refers to information about this product you should not overlook.

2 **Safety Information**



WARNING

Do not install or terminate fibers while a light source is active. Never look directly into a live fiber and ensure that your eyes are protected at all times.



WARNING

The use of controls, adjustments and procedures, namely for operation and maintenance, other than those specified herein may result in hazardous radiation exposure or impair the protection provided by this unit.



WARNING

If the equipment is used in a manner not specified by the manufacturer, the protection provided by the equipment may be impaired.



WARNING

Use only accessories designed for your unit and approved by EXFO. For a complete list of accessories available for your unit, refer to its technical specifications or contact EXFO.



IMPORTANT

When you see the following symbol on your unit , make sure that you refer to the instructions provided in your user documentation. Ensure that you understand and meet the required conditions before using your product.













IMPORTANT

Other safety instructions relevant for your product are located throughout this documentation, depending on the action to perform. Make sure to read them carefully when they apply to your situation.

Other Safety Symbols on Your Unit

One or more of the following symbols may also appear on your unit.

Symbol	Meaning
	Direct current
	Alternating current
	The unit is equipped with an earth (ground) terminal.
	The unit is equipped with a protective conductor terminal.
	The unit is equipped with a frame or chassis terminal.
	On (Power)
	Off (Power)
 OR 	On/Off (Power)
	Fuse

Laser Safety Information

Units with a Built-In VFL

Your instrument is a Class 2 laser product.

It is in compliance with standards IEC 60825-1: 2007 and 21 CFR 1040.10, except for deviations pursuant to Laser Notice No. 50, dated June 24, 2007. It is also in compliance with IEC 60825-1: 2014. Laser radiation is emitted at the output port.

The following label(s) indicate that the product contains a Class 2 source:



Details of the label affixed to back panel of unit.

The VFL laser is active when the  symbol is displayed in the power meter and VFL application.

The modules that you use with your unit may have different laser classes. Refer to the user guide or the online help of the different modules for the exact information.

Units without a Built-In VFL

If your unit is not equipped with a VFL, the laser class of your unit depends on the modules that you use. Refer to the user guide or the online help of the different modules for the exact information.

Electrical Safety Information

The FTB-2 and FTB-2 Pro models use an external AC/DC adapter connected to an international safety standard three-wire power cable.

The FTB-4 Pro model uses an international safety standard three-wire power cable. This cable serves as a ground when connected to an appropriate AC power outlet.



WARNING

- If you need to ensure that the unit is completely turned off, disconnect the power cable and remove the batteries. For more information on how to remove the batteries, see the section about replacing the batteries in this user documentation.
- Use only the certified power cord that is suitably rated for the country where the unit is used.
- Replacing detachable MAINS supply cords by inadequately RATED cords may result of overheating of the cord and create a risk of fire.

Safety Information

Electrical Safety Information

The color coding used in the electric cable depends on the cable. New plugs should meet the local safety requirements and include:

- adequate load-carrying capacity
- ground connection
- cable clamp



WARNING

- Never connect the unit to the AC mains when it is used outdoors.
- Position the unit so that the air can circulate freely around it.
- Operation of any electrical instrument around flammable gases or fumes constitutes a major safety hazard.
- To avoid electrical shock, do not operate the unit if any part of the outer surface (covers, panels, etc.) is damaged.
- Only authorized personnel should carry out adjustments, maintenance or repair of opened units under voltage. A person qualified in first aid must also be present. Do not replace any components while the power cable and batteries are connected.
- FTB-4 Pro unit only: Use only fuses with the required rated current and specified type (F6.3A L, 5 mm x 20 mm (0.197 in x 0.787 in), fast-acting, low-breaking capacity, 250 V). Do not use repaired fuses or short-circuited fuse holders.
- Unless otherwise specified, all interfaces are intended for connection to Safety Extra Low Voltage (SELV) circuits only.
- Capacitors inside the unit may be charged even if the unit has been disconnected from its electrical supply.



WARNING

- Use only the listed and certified AC adapter/charger provided by EXFO with your FTB-2 or FTB-2 Pro unit. It provides reinforced insulation between primary and secondary, and is suitably rated for the country where the unit is sold.
- When you use the unit outdoors, ensure that it is protected from liquids, dust, direct sunlight, precipitation, and full wind pressure.

Safety Information

Electrical Safety Information

Equipment Ratings	
Temperature	
➤ Operation	➤ unit powered by batteries: 0 °C to 50 °C (32 °F to 122 °F) ^{a,b}
	➤ unit connected to AC adapter (FTB-2 and FTB-2 Pro): 0 °C to 40 °C (32 °F to 104 °F)
	➤ unit connected to AC power directly (FTB-4 Pro): 0 °C to 50 °C (32 °F to 122 °F)
➤ Storage	➤ unit without batteries: -40 °C to 70 °C (-40 °F to 158 °F)
	➤ unit with batteries: -20 °C to 60 °C (-4 °F to 140 °F)
Relative humidity ^c	➤ unit: ≤ 95 % non-condensing
	➤ AC adapter: 10 % to 80 % non-condensing
Maximum operation altitude	➤ 2000 m (6562 ft) (unit connected to external power source)
	➤ 5000 m (16405 ft) (unit operated from batteries)

Equipment Ratings	
Pollution degree	<ul style="list-style-type: none"> ➤ FTB-2 and FTB-2 Pro: <ul style="list-style-type: none"> ➤ 2 (unit connected to external power source) ➤ 3 (unit operated from batteries)^d ➤ FTB-4 Pro: 2
Overvoltage category	<ul style="list-style-type: none"> ➤ unit (FTB-2 and FTB-2 Pro): I ➤ unit (FTB-4 Pro): II ➤ AC adapter: II
Measurement category	Not rated for measurement categories II, III, or IV
Input power ^e	<ul style="list-style-type: none"> ➤ unit (FTB-2): --- 24 V; 3.75 A ➤ unit (FTB-2 Pro): --- 24 V; 8.33 A ➤ unit (FTB-4 Pro): ~ 100 - 240 V; 50/60 Hz; 5.2 - 1.9 A ➤ AC adapter (FTB-2): ~ 100 - 240 V; 50/60 Hz; 2.5 - 1.0 A ➤ AC adapter (FTB-2 Pro): ~ 100 - 240 V; 50/60 Hz; 3.5 - 2.5 A

- a. When the unit is used at an altitude of 5000 m, the maximum operating temperature is 32 °C (89.6 °F)
- b. Operating time is dependent upon power consumption and temperature. If the unit is used at maximum power and maximum temperature, it will power off automatically any time after 10 minutes for safety reasons.
- c. Measured in 0 °C to 31 °C (32 °F to 87.8 °F) range, decreasing linearly to 50 % at 40 °C (104 °F).
- d. Equipment must be normally protected against exposure to direct sunlight, precipitation and full wind pressure.
- e. Not exceeding ± 10 % of the nominal voltage.

Safety Information

Electrical Safety Information



CAUTION

- The use of voltages higher than those indicated on the label affixed to your unit may damage the unit.
- The operation and storage temperatures, as well as the altitude and relative humidity values of some modules may differ from those specified for your platform. In this case, always ensure that you comply with the most restrictive conditions (either module or platform).

3 Getting Started with Your Unit

Grounding Your Unit

When you perform outside plant tests with certain modules, you may want to ground your unit because it can be exposed to overvoltages from the telecommunication network. Refer to the user documentation that comes with your modules to know if you need to ground your unit.



WARNING

- Not grounding your unit when it is recommended may cause serious injuries to communication network staff or other users.
- Ensure to ground the unit using a grounding method that complies with your local regulations. If you are not sure on how to proceed, consult a certified electrician.

Note: *To ground your unit, you need a grounding wire (18 AWG minimum) with a U-shaped terminal.*

Getting Started with Your Unit

Grounding Your Unit

To ground your unit:

1. Position the unit so that you can see its left panel.
2. Place the U-shaped terminal under the grounding stud's screw head.

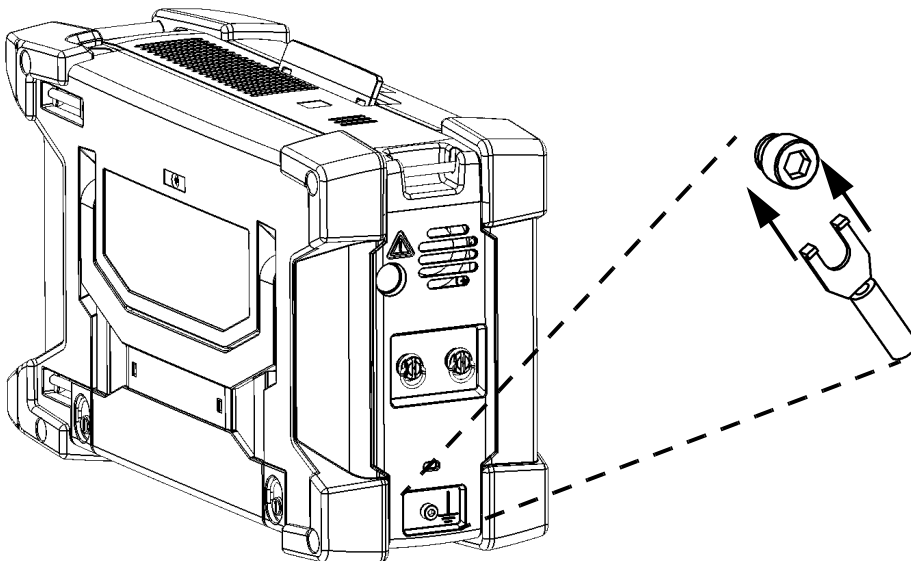

3. Turn the grounding stud clockwise to screw it tight.
 4. Ground the other end of the wire as per your local regulation.
- Your unit is now grounded properly.

Positioning Your Unit

You can position your unit either vertically (with the screen facing you), or at an angle, using the support on the back panel. With the FTB-2 and FTB-2 Pro models, you can also hold your unit with the provided hand strap.

Note: *The stand ensures optimum stability to the unit during your tests.*



CAUTION

With the FTB-4 Pro, always ensure that the support is fully extended when you use it. This will ensure maximum stability and prevent injuries as well as damage to the test components.

To position the unit using the support:

Pull out the support.

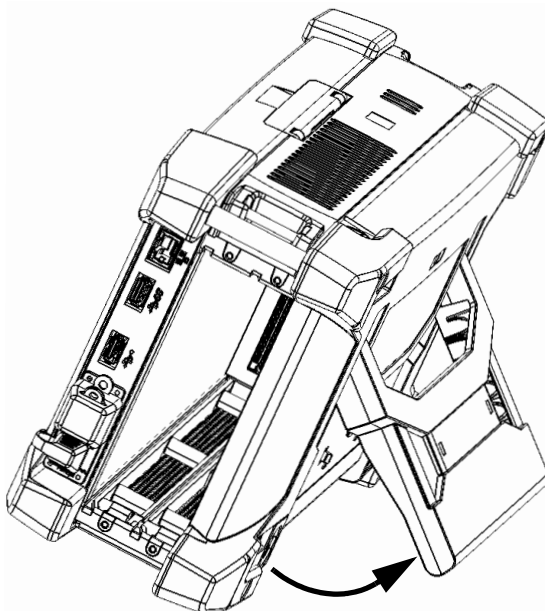

Getting Started with Your Unit

Installing the Carry Handle

Installing the Carry Handle

You can install a carry handle on your unit.

Note: *If you wish to use a shoulder strap (sold separately by EXFO), you must first install the carry handle.*

To install the carry handle:

1. Position the unit so that its front panel is facing you, and that you can see its top panel.

Top panel



2. Ensure that both ends of the carry handle are fully extended.

Getting Started with Your Unit

Installing the Carry Handle

3. Place the handle flat on the top of your unit as shown below.



4. Slide each end of the handle *under* the corresponding metal rod.
5. Pull on the straps until the base of each D-shaped metal ring rests on the corresponding rod.



6. Slide the straps through the D-shaped rings.



Getting Started with Your Unit

Installing the Carry Handle

7. Fold the Velcro straps towards the center. Both ends should meet without any gap.



8. Fold the large part of the handle over the straps, and secure it in place with the Velcro.



You are now ready to use the carry handle, or to attach a shoulder strap (see *Installing the Shoulder Strap* on page 39).

Installing the Shoulder Strap

Your unit comes with a hand strap (FTB-2 and FTB-2 Pro) and a carry handle, but you can also install an optional shoulder strap for more versatility.



CAUTION

Always attach the snap hooks of the shoulder strap to the D-shaped metal rings of the carry handle. Attaching the shoulder strap anywhere else could damage your unit or cause your unit to fall.

To install the shoulder strap:

Attach each of the snap hooks to a D-shaped metal ring of the carry handle (one hook per ring), as shown below.

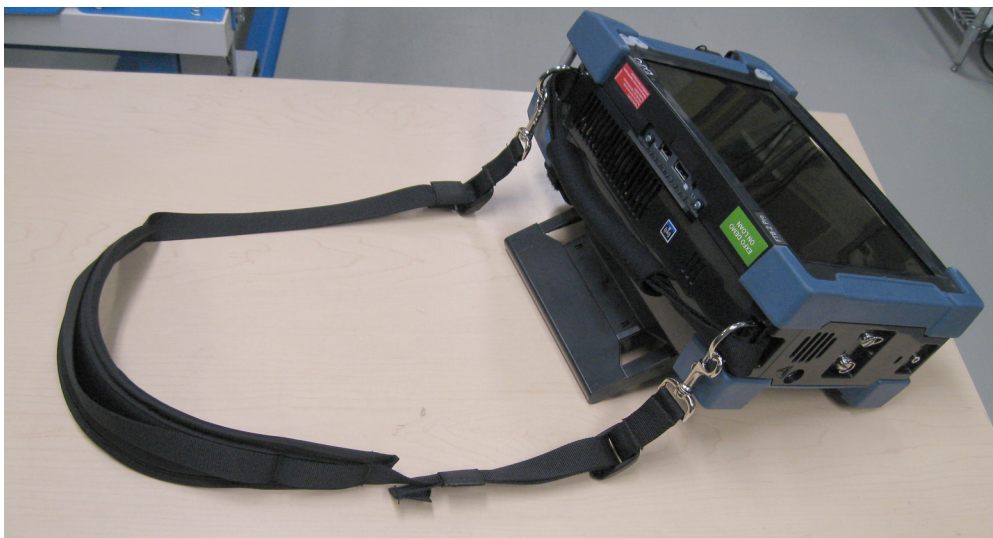

Getting Started with Your Unit

Installing or Removing FTB Module Adapters

Installing or Removing FTB Module Adapters

You can insert FTBx modules, FTB modules, or a combination of both in your unit. If you intend to work with FTB modules and your unit is not already equipped with module adapters, you must first install such adapters. These adapters must be removed before inserting FTBx modules.

To install the FTB modules adapters:

1. Position the adapter so that you can see the retaining screw as shown below.

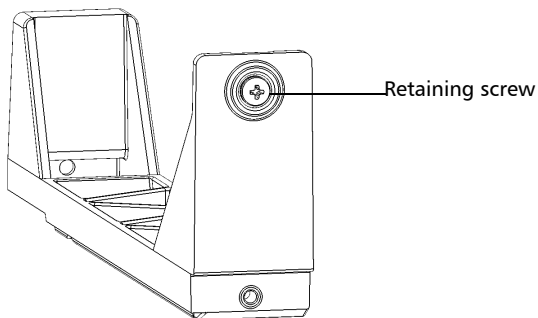

Getting Started with Your Unit

Installing or Removing FTB Module Adapters

- 2. Slide the adapter into the unit until it stops, making sure that the retaining screw is well aligned with the corresponding screw hole on the unit.

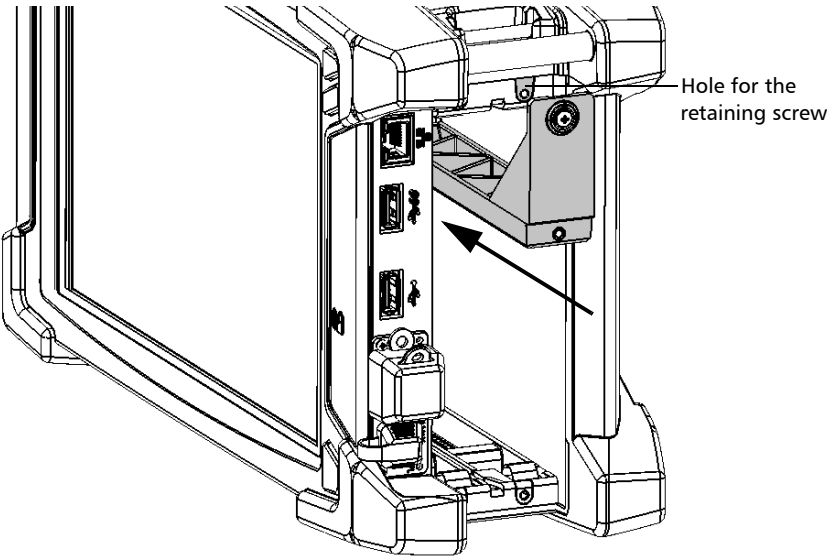

Getting Started with Your Unit

Installing or Removing FTB Module Adapters

3. Using a screwdriver, turn the retaining screw clockwise to secure the adapter in place.

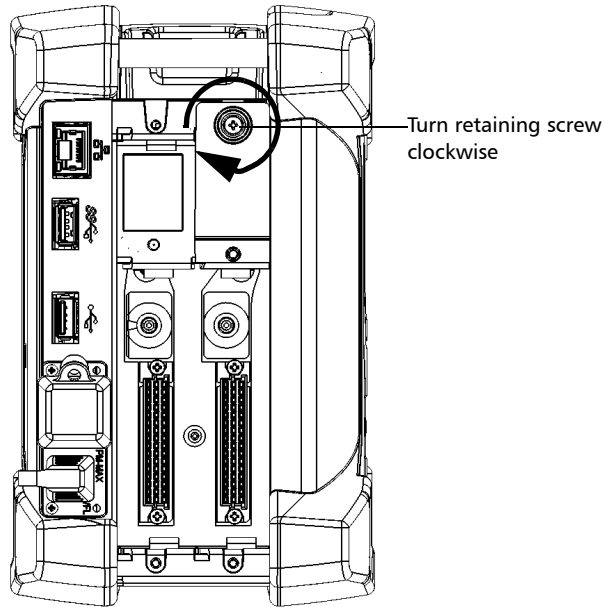

4. If necessary, repeat the steps above with another adapter.
You are now ready to work with FTB modules.

To remove the FTB modules adapters:

1. Using a screwdriver, turn the retaining screw counterclockwise until it is loose. Since it is a captive screw, you cannot remove it completely.

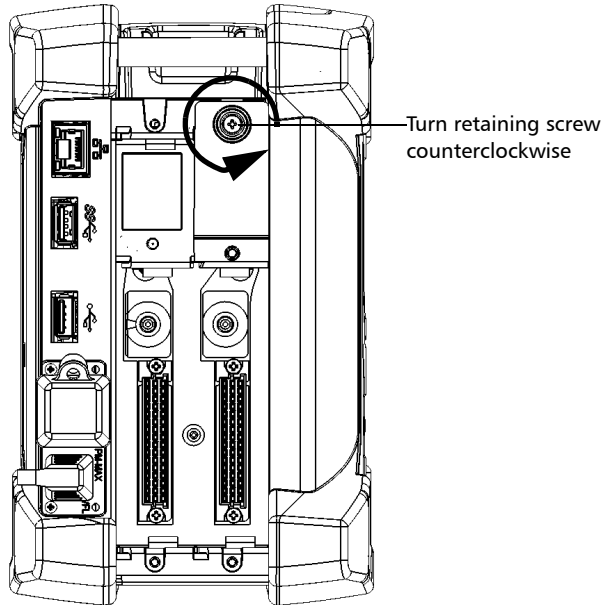

Getting Started with Your Unit

Installing or Removing FTB Module Adapters

2. Place your fingers just under the protruding edge on the faceplate of the adapter, and then slide the adapter out of the unit.

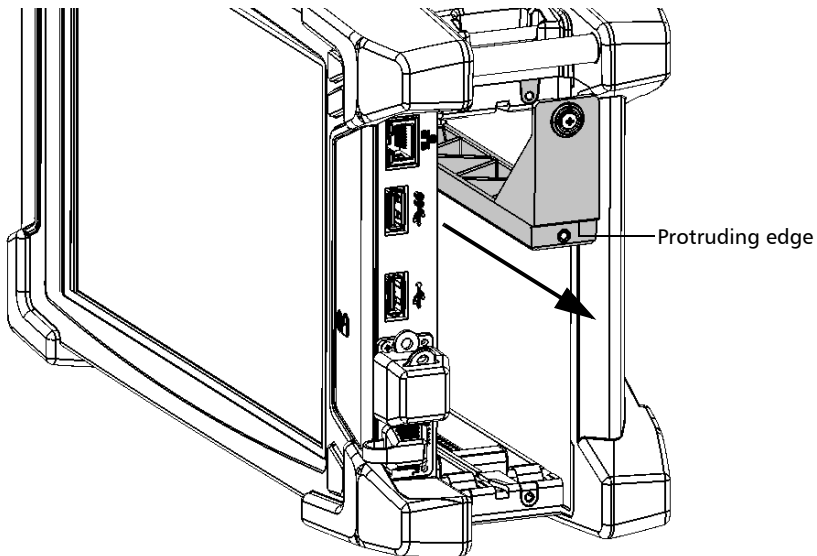

3. If necessary, repeat the steps above with the second adapter.
You are now ready to work with FTBx modules.

Inserting and Removing Test Modules



CAUTION

- ▶ For FTB modules: Never insert or remove a module while the FTB-2, FTB-2 Pro, or FTB-4 Pro unit is turned on. This will result in immediate and irreparable damage to both the module and unit.
- ▶ For FTBx modules: There is no need to turn off your unit before inserting or removing test modules. However, removing modules without following the instructions provided in this user documentation could have unfortunate consequences. Doing so could result in unexpected behavior of the test applications, instability of the system, or even cause irreparable damage to your modules, depending on the operation underway when the modules are removed.

Front

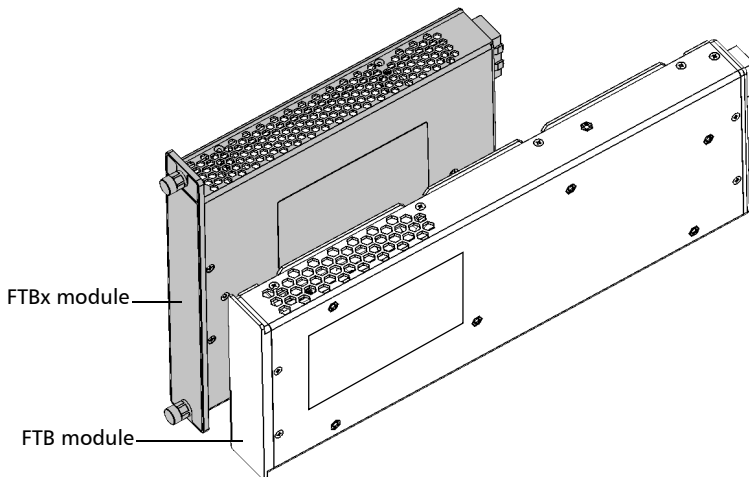

Getting Started with Your Unit

Inserting and Removing Test Modules



CAUTION

Your unit is compatible with some of the FTBx modules and some of the FTB modules. For a list of supported modules, refer to your unit's technical specifications. To avoid damaging your unit, use it only with modules approved by EXFO.



IMPORTANT

You can insert FTBx modules, FTB modules, or a combination of both in your unit. However, to be able to work with the FTB modules, you need to first install module adapters. These adapters must be removed before inserting FTBx modules. For more information on how to install or remove the module adapters, see the corresponding section in this documentation.

To insert a module into the unit:

1. If you are working with an FTB module, turn off your unit (shut down, not hibernate or sleep). Otherwise, you can go directly to step 2.
2. Position the unit so that its right panel is facing you.

Getting Started with Your Unit

Inserting and Removing Test Modules

- 3. Take the module and place it so that the connector pins are at the back, as explained and shown below.

The identification sticker must be on the right side and the protruding edges on the left side. In the case of the FTB modules, ensure that the retaining screw hole is *over* the connector pins.

Right panel

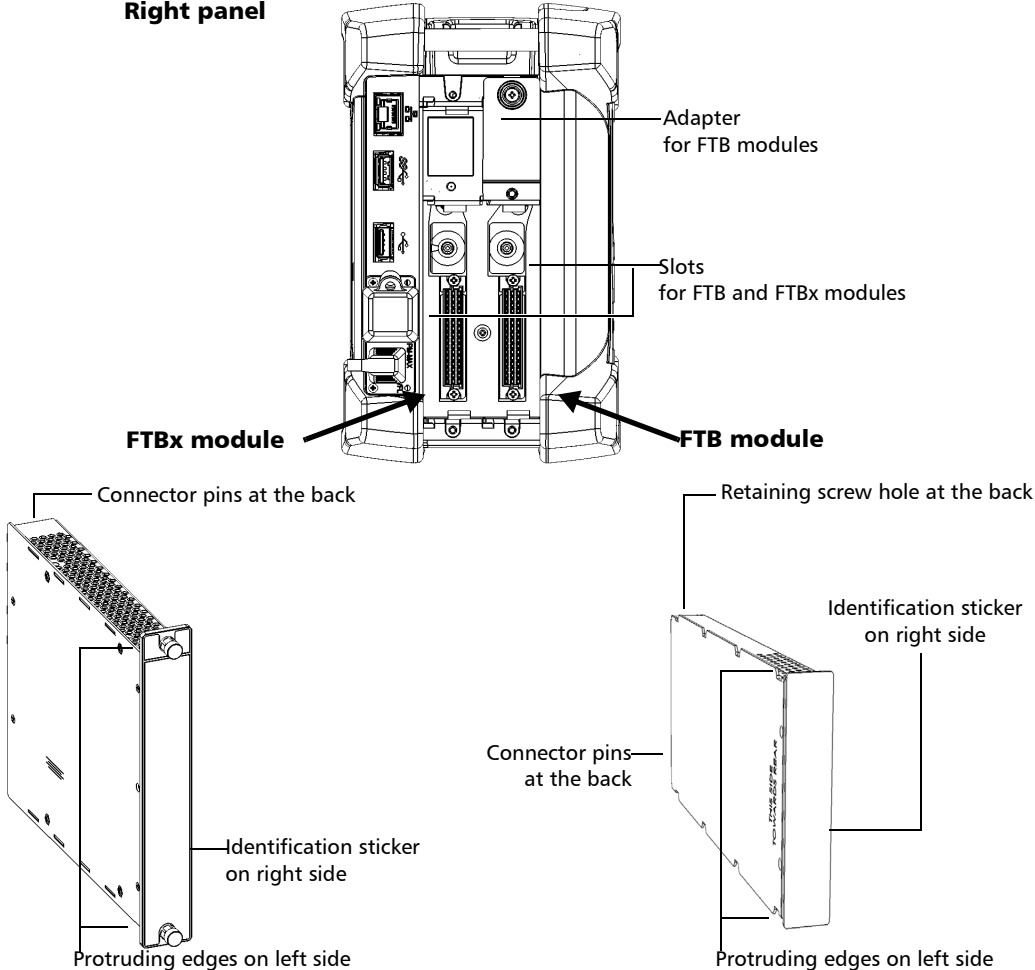

Getting Started with Your Unit

Inserting and Removing Test Modules

4. Insert the protruding edges of the module into the grooves of the receptacle's module slot.
5. Push the module all the way to the back of the slot, until it stops.
6. If you are working with an FTBx module, turn the two retaining screws clockwise until they are tightened.

This will secure the module into its “seated” position.

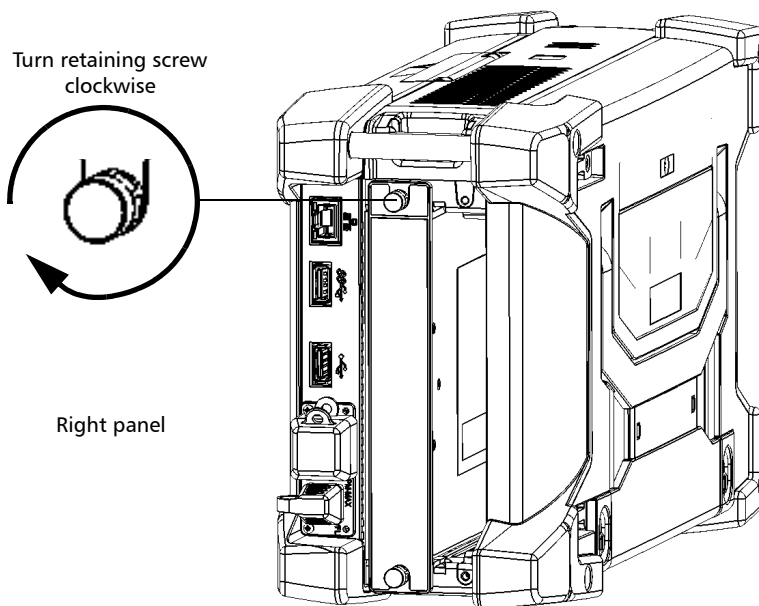

Getting Started with Your Unit

Inserting and Removing Test Modules

- 7. If you are working with an FTB module, secure it as follows:
 - 7a. Place the unit so that its left panel is facing you.
 - 7b. While applying slight pressure to the module, lift the mobile part of the retaining screw and use it to turn the retaining screw clockwise until it is tightened.

This will secure the module into its “seated” position.

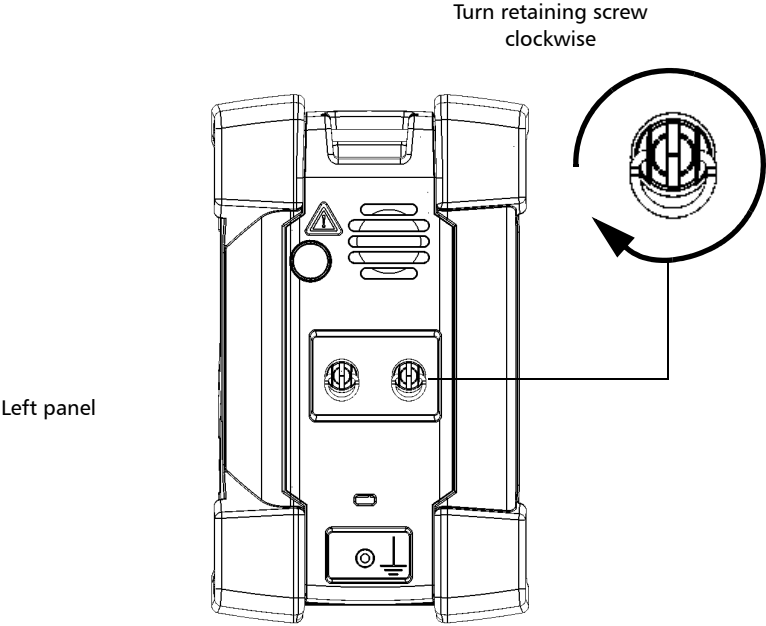

Getting Started with Your Unit

Inserting and Removing Test Modules



IMPORTANT

For FTB modules: EXFO recommends that you use the front locking screws to secure the modules in your unit, especially when you work with heavier modules such as the OSA, or the FTB-88100NGE PowerBlazer.

8. If you are working with a larger or heavier FTB module, secure it with locking screws as follows:
 - 8a. Position the unit so that its right panel is facing you.
 - 8b. Insert a locking screw in one of the screw holes on the front of the unit.

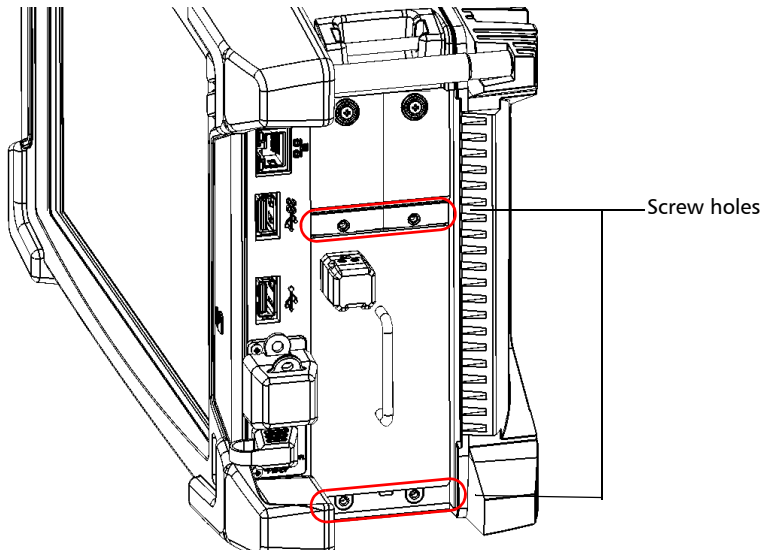

- 8c.** Turn the screw clockwise until it makes contact with the faceplate of the module.

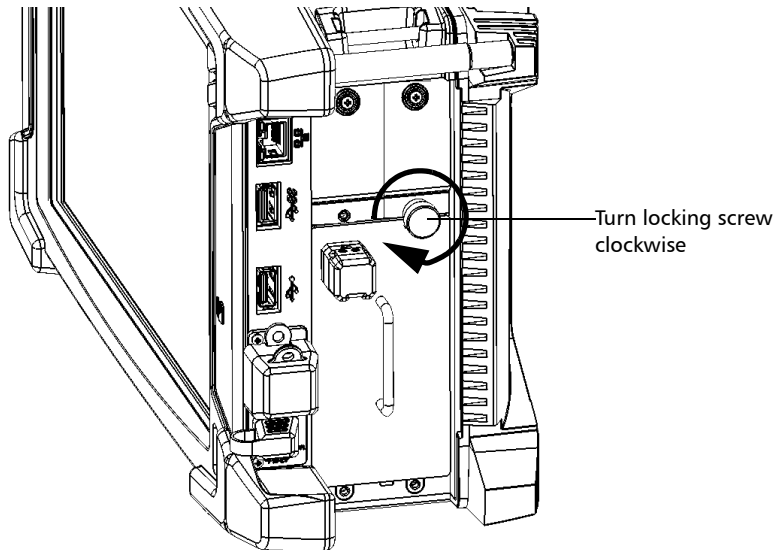

- 8d.** Repeat steps 8b and 8c with the three remaining screws.
- 9.** If you have just inserted an FTB module, turn on the unit. The module will be detected automatically during the startup sequence.

Note: *If you are working with an FTBx module, it will be detected automatically after the insertion, which means that you do not have to restart the unit.*

Getting Started with Your Unit

Inserting and Removing Test Modules

To remove a module from the unit:

1. If you want to remove an FTB module, turn off your unit (shut down, not hibernate or sleep).

OR

If you want to remove an FTBx module, from ToolBox X, tap the  button.

Note: The  button is not available for the FTB modules because they do not support ejection.



CAUTION

Once you have pressed the  button, wait until the status of the module switches to “Safe to Remove” in ToolBox X.

2. Position the unit so that its right panel is facing you.

Getting Started with Your Unit

Inserting and Removing Test Modules

- 3. If you are working with an FTBx module, turn the two retaining screws counterclockwise until they are loose. Since they are captive screws, you cannot remove them completely.

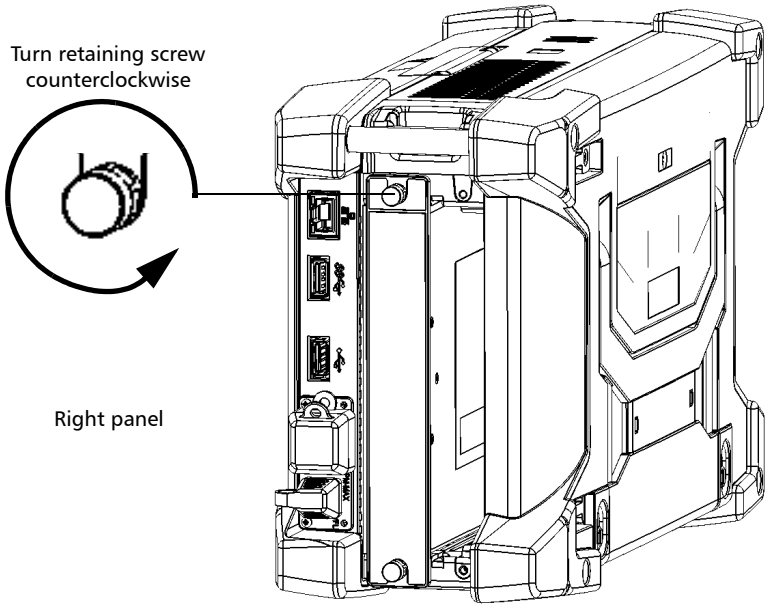

Getting Started with Your Unit

Inserting and Removing Test Modules

4. If you are working with an FTB module, proceed as follows:
 - 4a. Turn one locking screw counterclockwise until you can remove it completely.

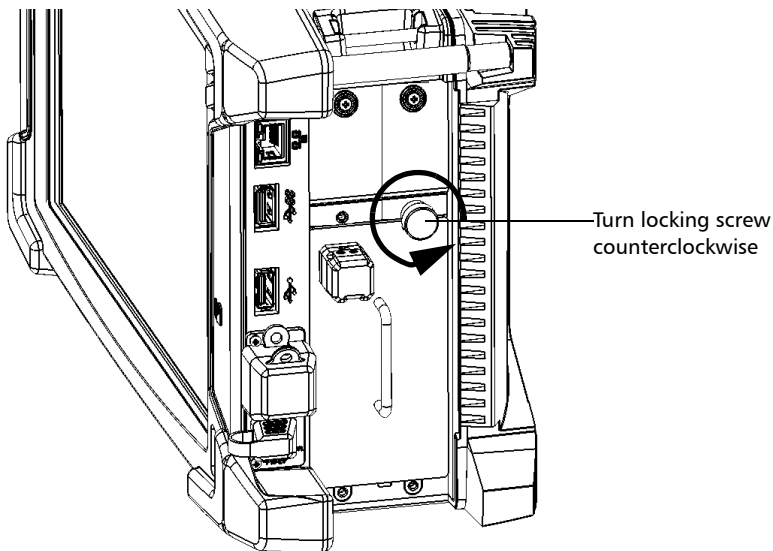

- 4b. Remove the three remaining screws in the same way.
 - 4c. Position the unit so that the left panel is facing you.

Getting Started with Your Unit

Inserting and Removing Test Modules

- 4d.** Lift the mobile part of the retaining screw and use it to turn the retaining screw counterclockwise until it stops.

The module will be slowly released from the slot.

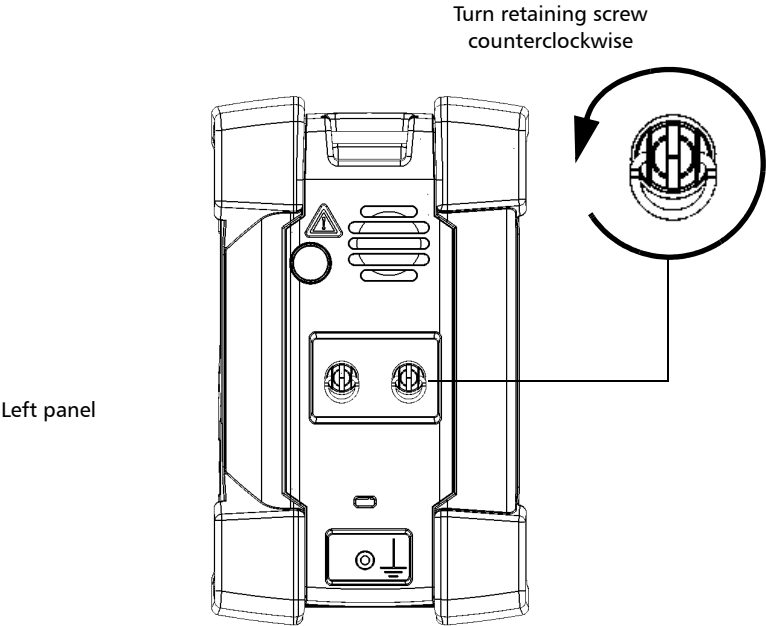

- 4e.** Place the unit so that the right panel is facing you.
- 5.** Hold the module by its sides or by the handles (*NOT by the connectors*) and pull it out.

Note: *On the FTBx modules, the retaining screws can be used as handles to pull out the module safely.*

Getting Started with Your Unit

Inserting and Removing Test Modules

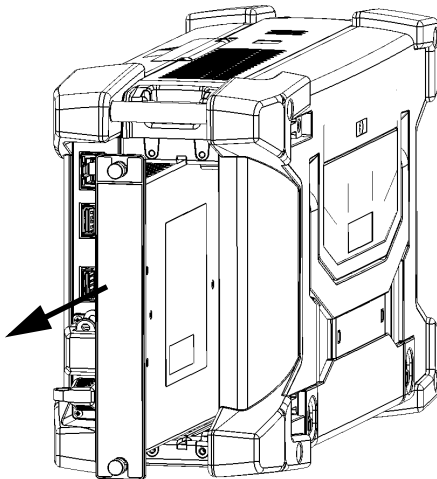

CAUTION

Pulling out a module by its connectors could seriously damage both the module and connectors. Always pull out a module by its casing or the handles.

6. Cover empty slots with the supplied protective covers.



CAUTION

Failure to reinstall protective covers over empty slots will result in ventilation problems.

Turning On Your Unit

When you turn on the unit for the very first time, a wizard for license agreements and safety instructions is displayed (see the corresponding section for more information).

Once you have accepted all the license agreements and confirmed the reading of safety instructions, the main window is displayed.

To turn on the unit:

Press the On/Off button.

Turning Off Your Unit

There are several ways to turn off the unit, including the following:

- *Sleep*: keeps the unit's status information in memory (RAM). The next time you turn your unit on, you will quickly return to your work environment (running applications will still be running). This mode will take more battery power while the unit is off.
- *Hibernation*: saves the unit's status information that was in memory (RAM) to a special file on the disk. The next time you turn your unit on, this file will be used to ensure that you return to your work environment (running applications will still be running). The unit will take longer to start up than in *Sleep* mode, but it requires less battery power when the unit is off.
- *Shutdown*: the unit will perform a complete restart routine the next time you use it. You should perform a shutdown if you do not intend to use your unit for a week or more.

After a shutdown, the unit will start in Toolbox X or in the application you defined as the startup application.

Note: *Should the unit ever stop responding, you can force a hardware reset by pressing and holding down the power button for more than 15 seconds.*

Getting Started with Your Unit

Turning Off Your Unit

By default, your unit will shut down when you press the power button. However, you can configure your unit to perform a different action when the power button is pressed.

You can also configure your unit to automatically restart when AC power comes back after the unit has turned off (power outage, emergency shutdown, sleep, or hibernation modes) when battery level is too low.

To exit the sleep mode (or hibernation mode) and resume your work:

Press the On/Off button.

To turn off the unit completely from the unit itself:

Press the On/Off button.

To turn off the unit completely from Windows 10:

1. From the lower left corner of the screen, tap the **Start** button ()
2. From the **Start** menu, tap .
3. Tap **Shut down**.

To turn off the unit completely from Windows 8.1 Pro or Windows Embedded 8 Standard:

1. From the right side of the screen, swipe left to display the Charm bar. For more information, see the section about working with Windows 8.1 Pro or Windows Embedded 8 Standard.
2. Tap **Settings > Power > Shut down**.

To define the behavior of the power button:

- 1. From the main window, tap the **System Settings** button.
- 2. Tap **Control Panel**.

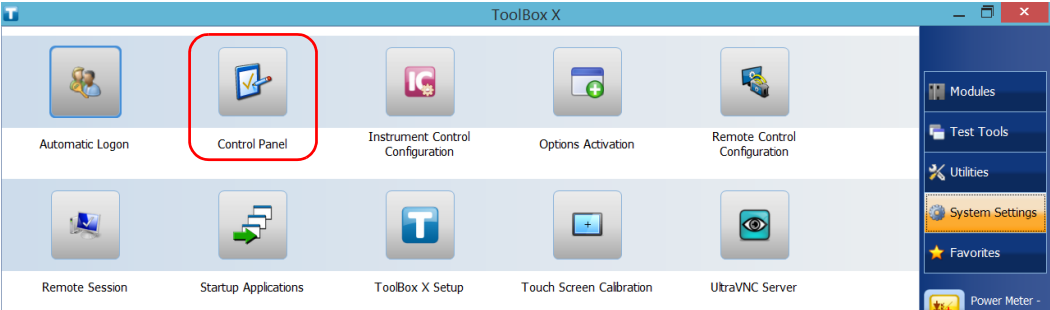

- 3. Tap **Hardware and Sound**.

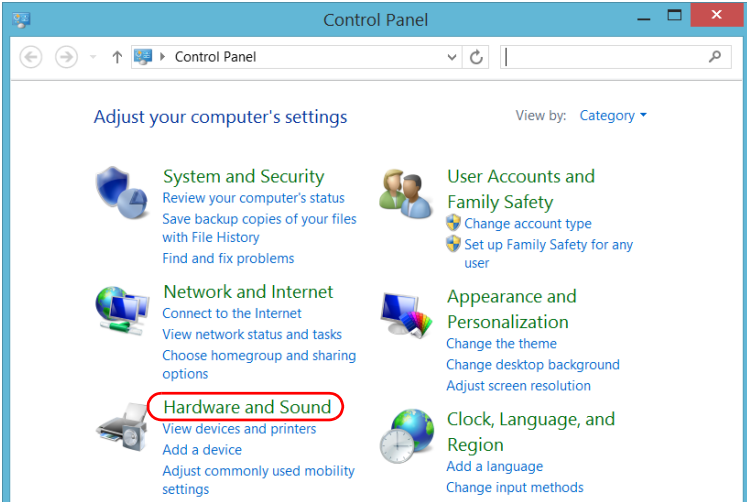

Getting Started with Your Unit

Turning Off Your Unit

4. Under **Power Options**, tap **Change what the power buttons do**.

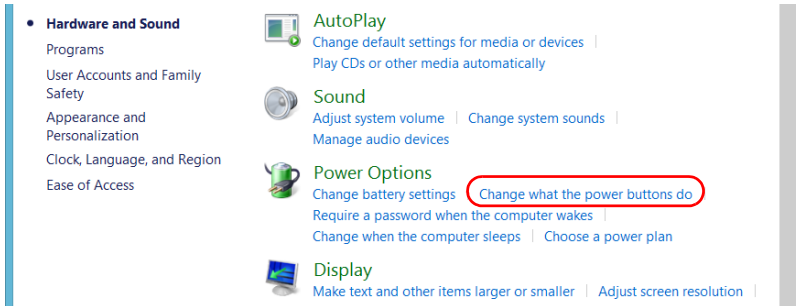

5. Tap **Changes settings that are currently unavailable**.

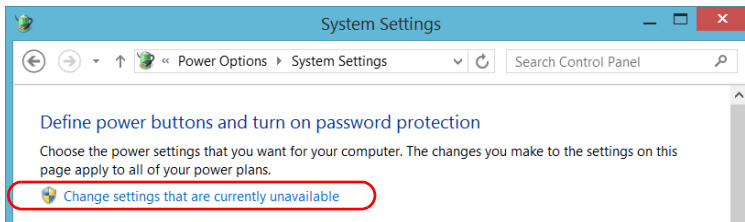

- 6. From the **When I press the power button** lists, select the desired behavior when the unit is powered by batteries, or by AC current (**Shut down** option is selected by default in both cases).

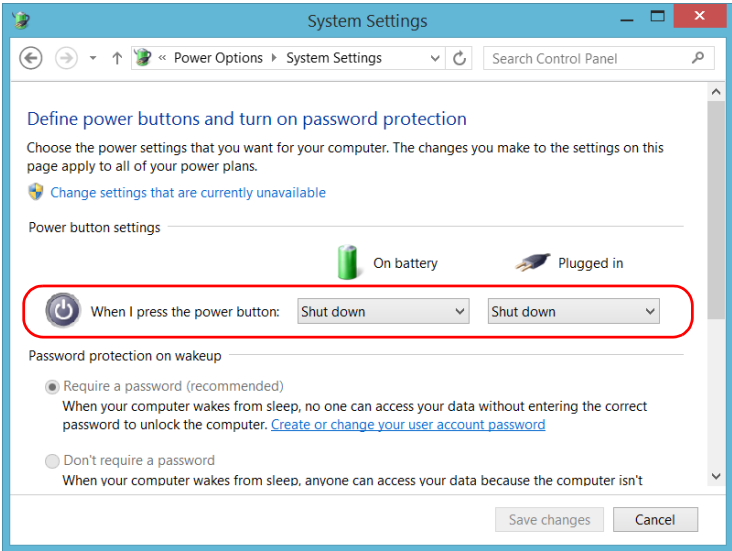

- 7. Tap **Save changes** to confirm the changes and return to the **Power Options** window.

Getting Started with Your Unit

Turning Off Your Unit

To configure your unit to automatically restart after AC power comes back:

1. From the main window, tap the **System Settings** button.
2. Tap **ToolBox X Setup**.

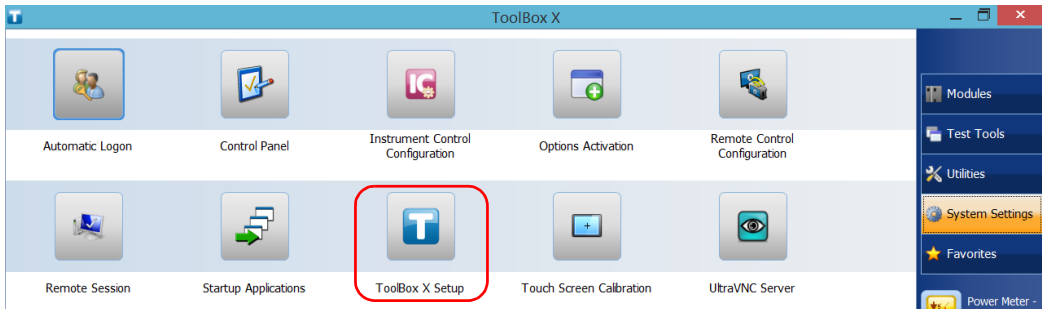

3. Select the **Power on the unit when AC outlet is connected or after power outage** box to enable the corresponding option.

OR

Clear the box if you prefer that your unit does not restart automatically after AC power comes back.

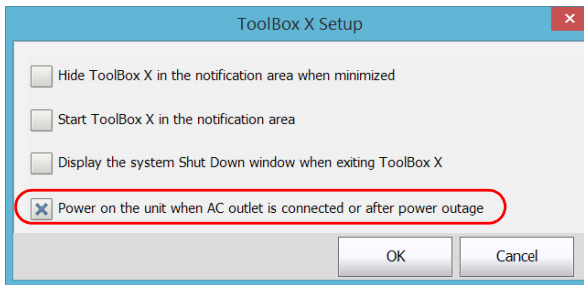

4. Tap **OK** to confirm the changes and return to the **System Settings** window.

Configuring Your Unit At First Startup

The first time you turn on the unit, a Windows configuration wizard is displayed, enabling you to set all the regional and language settings such as the country and operation language.



IMPORTANT

The operation language that you select at the first startup (labelled "App language") becomes the default system language, that is the language that will be available at logon.

During the configuration process, you will also be asked to read and accept the Microsoft end-user license agreement (EULA).

Once the configuration is complete in Windows, an EXFO wizard will be displayed, allowing you to read the user documentation for important safety information, and to read and accept the EULA related to your unit and instruments.

Note: *To be able to work with the unit, you must accept all the EULA (from Microsoft and EXFO), and confirm that you have read the security information.*

To configure your unit at first startup:

1. If it is not already done, turn on the unit (see *Turning Off Your Unit* on page 57).
2. When the Windows wizard is displayed, set the parameters according to your needs.
3. Read and accept the Microsoft EULA.
The configuration of Windows parameters may take several minutes.

Getting Started with Your Unit

Configuring Your Unit At First Startup

- When the EXFO wizard is displayed, follow the on-screen instructions.

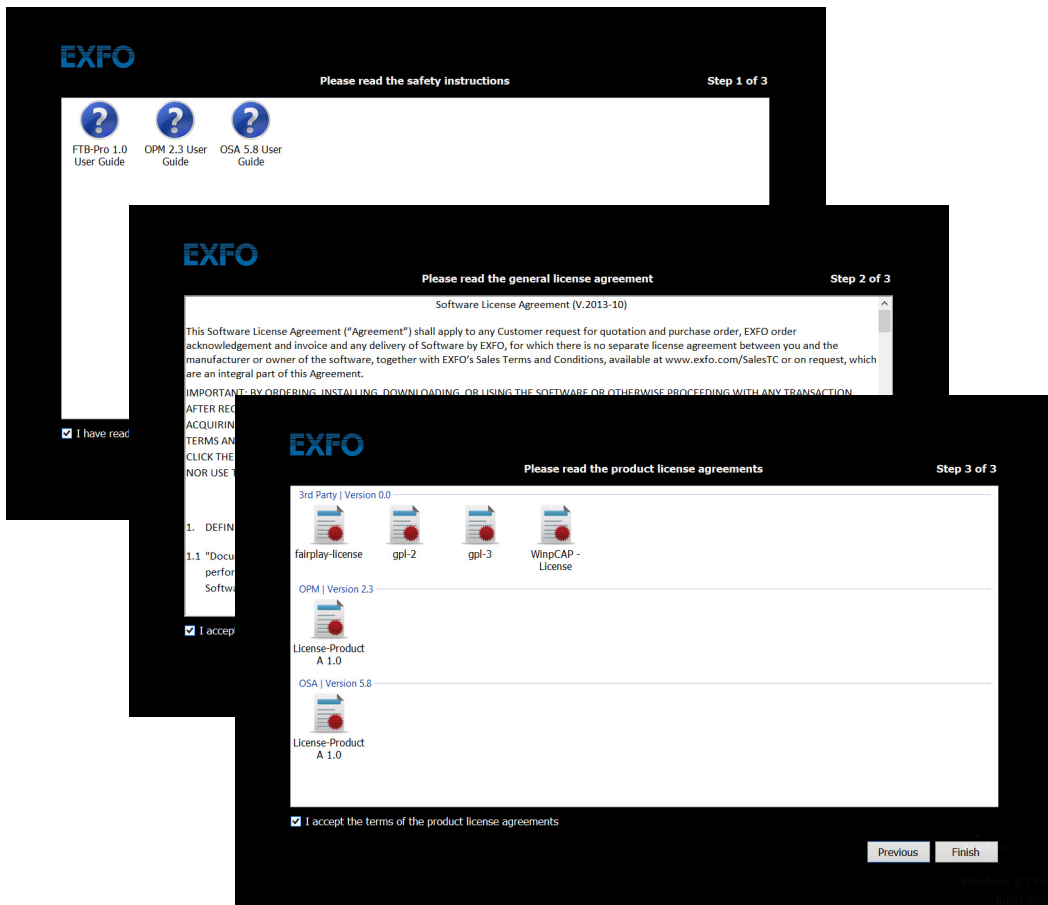

- Tap **Finish** to close the wizard and start working.

Accessing and Exiting ToolBox X

By default, ToolBox X is displayed automatically when you turn on the unit.

However, you can configure your unit to send ToolBox X to the notification area (see *Setting ToolBox X Behavior* on page 132). This could be useful, for example, if you prefer to start working in Windows. You can also configure your unit to start any of the available applications as soon as ToolBox X is started (see *Selecting the Startup Applications* on page 102).

To access ToolBox X from the Windows environment:

Double-tap the  icon on your desktop.
ToolBox X

Note: *If ToolBox X has been sent to the notification area, from this location, right-click the  icon, and then select **Restore ToolBox X**.*

To exit ToolBox X:

Tap .

Getting Started with Your Unit

Starting Module Applications

Starting Module Applications

Your modules can be configured and controlled from their dedicated applications in Toolbox X.

To start a module application:

1. If necessary, tap the **Modules** button to display the modules window.

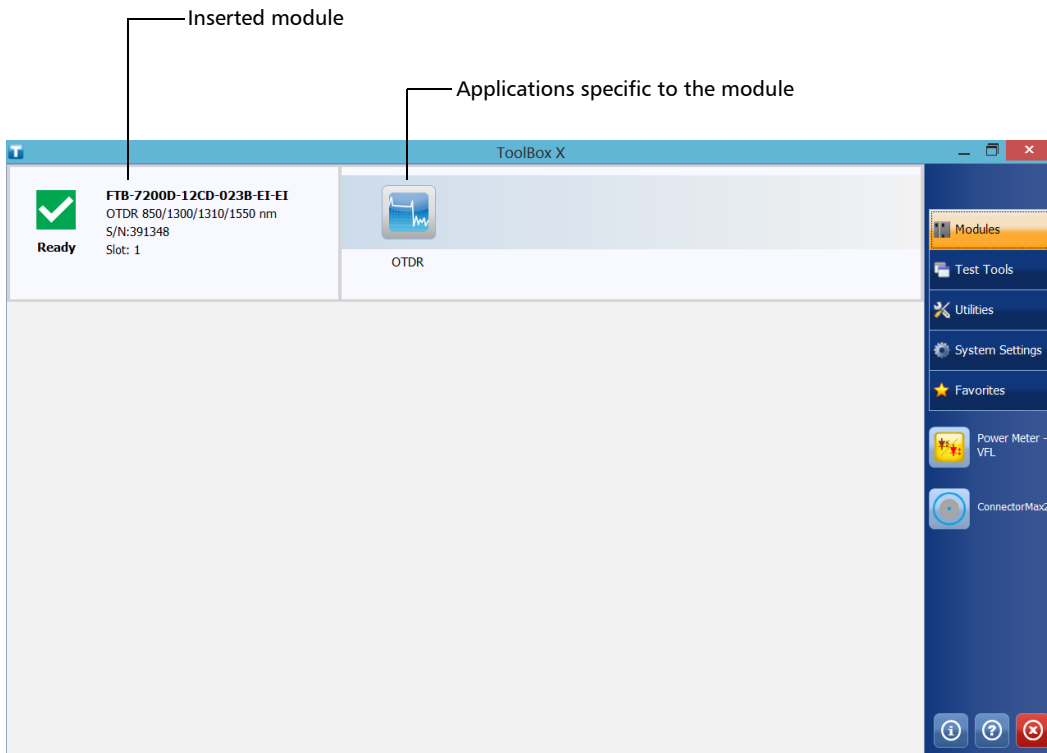

2. On the row corresponding to the desired module, tap the icon of the application with which you want to work.

Using the On-Screen (Virtual) Keyboard

Whenever you need to enter alphanumeric data, you can use the on-screen keyboard. This keyboard supports multilingual features, and functions according to the keyboard settings set in Windows.

To use the on-screen keyboard:

1. Select the location where you want to enter text.
2. From the unit's front panel, press the  button.
OR
3. From the taskbar, tap the on-screen keyboard icon (located to the left of the clock).

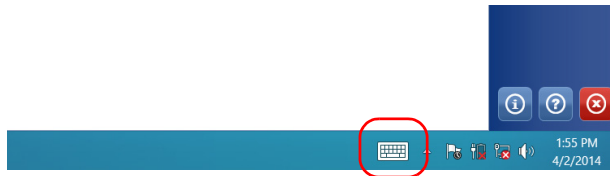

4. Enter the data as required.
5. Close the keyboard when you are done entering data.

Working with Windows 8.1 Pro or Windows Embedded 8 Standard

If you are not familiar with Windows 8.1 Pro (FTB-2 Pro) or Windows Embedded 8 Standard (FTB-2), you may want to visit Microsoft Web site for tutorials as well as detailed information on the features and concepts brought by this operating system.

One of the new features is the use of touchscreen gestures to perform certain tasks. In this documentation, all the necessary gestures are explained throughout the procedures.

Note: *For an optimal accuracy with the touchscreen, use the stylus provided with your unit.*

Here is an overview of the gestures that you may use the most with your unit.

- Tap and double-tap: Equivalent of a click and double-click with a mouse.
- Swipe right: To return to the last used application.
From the left edge of the screen, swipe towards the right.

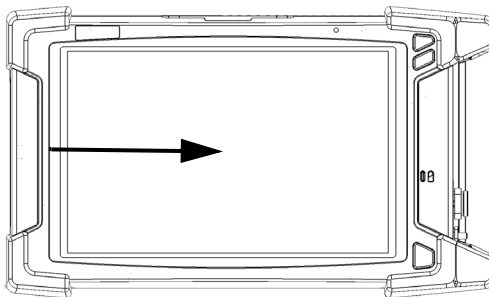

Getting Started with Your Unit

Working with Windows 8.1 Pro or Windows Embedded 8 Standard

- **Swipe down:** To close windows that do not have a close button. From the top edge of the screen, swipe towards the bottom.

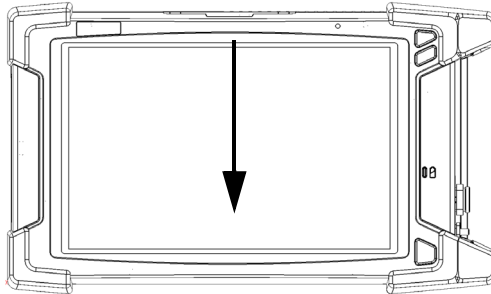

- **Swipe left:** To display the Charm bar, which is a special toolbar that gives you access to many tools and settings. From the right edge of the screen, swipe towards the left.

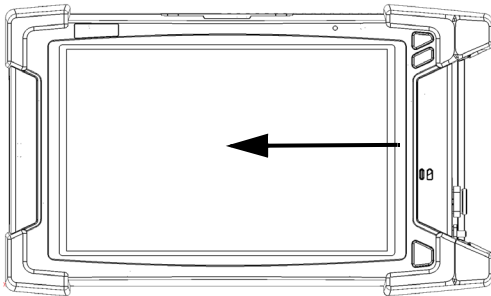

Right-Clicking with the Touchscreen

If you are used to work with a mouse, you may find it useful to be able to perform a right-click on your touchscreen.

This feature is enabled by default, but you can disable it if you prefer. You can also modify the right-click behavior. For more information, see *Customizing the Right-Click Feature* on page 94.

To right-click with the touchscreen:

From the location where you want to right-click, using the stylus or any blunt pointing device, press the screen for a few seconds until the shortcut menu appears.

If you want to hide the shortcut menu without performing any action, simply tap anywhere outside the menu.

Installing or Upgrading the Applications

All the necessary applications have been preinstalled and configured at the factory. However, you may have to upgrade some applications when new versions become available or to reinstall them.

Note: *Only administrator-level users can install software under Windows.*

Each time you purchase a new module, it could be a good idea to verify that the most recent Update Manager application is installed on your unit.

When updates are available for an application, you will need to download them from EXFO Apps, either directly on your unit or on a computer. The update files must be copied to the location that has been specified for the deployment packages in Update Manager.

For the installation or upgrade, you will need:

- your unit
- a computer equipped with a USB port; Windows must be installed on the computer
- a USB memory key

Note: *The computer and USB key are only necessary if you do not wish to download the files directly on your unit.*

Note: *For more information on the installation, refer to the Update Manager online help.*

Getting Started with Your Unit

Installing or Upgrading the Applications

To update or reinstall Update Manager:

- 1.** If necessary, retrieve the desired installation files from EXFO Apps at <http://www.exfo.com/software/exfo-apps>.

If you do not intend to download files directly on your unit, connect a USB memory key to one of the USB ports of the computer and copy the installation files to this USB key.
- 2.** If it is not already done, turn on your unit.
- 3.** Exit Toolbox X and the modules' applications.
- 4.** If you want to install Update Manager using the USB key, disconnect it from the computer and connect it to one of the USB ports of your unit.
- 5.** On your unit, create a folder on the Windows desktop.
- 6.** Copy the installation files (from the USB key) to the newly created folder.
- 7.** From the newly created folder, double-tap the Update Manager setup file to start the installation.
- 8.** Follow the on-screen instructions.
- 9.** When the installation is complete, simply disconnect the USB memory key.

To install or upgrade the applications:

1. If necessary, retrieve the desired installation files from EXFO Apps at <http://www.exfo.com/software/exfo-apps>.

If you do not intend to download files directly on your unit, connect a USB memory key to one of the USB ports of the computer and copy the installation files to this USB key.

2. If it is not already done, turn on your unit.
3. Exit Toolbox X and the modules' applications.
4. If you want to install or update applications using the USB key, disconnect it from the computer and connect it to one of the USB ports of your unit.
5. Copy the installation files (from the USB key) to the folder containing the update and installation packages on your unit. By default, Update Manager will search for files at the root of the USB key. For more information, refer to the Update Manager online help.
6. On your unit, from Windows desktop, double-tap the **Update Manager** icon to start the corresponding application. For more information on how to install or upgrade applications, refer to the Update Manager online help.
7. When the installation is complete, simply disconnect the USB memory key.

Activating Software Options

The software options purchased at the same time as your unit have been activated for you already. However, if you purchase options afterwards, you will have to activate them yourself.

Before being able to activate options, you need to contact EXFO with the following information:

- Purchase order number of the newly purchased options
- Module or platform serial number (depending on whether the software options were purchased for a module or the platform)
- Customer's name
- Customer's company name
- Customer's phone number
- Customer's e-mail address
- Module or platform on which the option will be installed

You will receive a single key (.key) file with which you will be able to unlock all the new options that you have purchased.

To activate software options for your unit or module:

1. From the main window, tap the **System Settings** button, and then tap **Options Activation**.

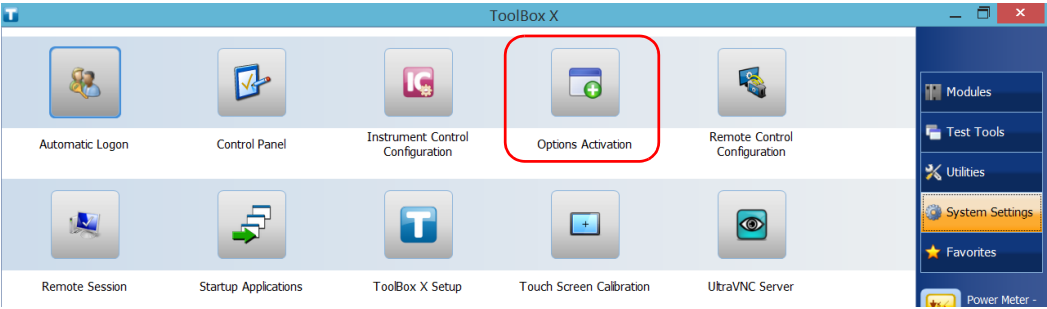

Getting Started with Your Unit

Activating Software Options

2. Tap the **Platform Options** tab or the **Module Options** tab, depending on the type of options that you want to activate.

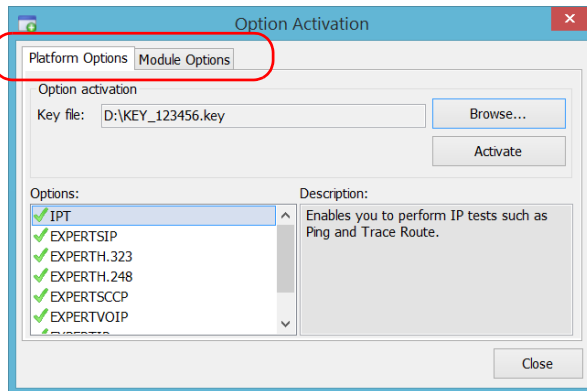

3. Use the **Browse** button to locate the key file that you want to use.
4. Tap **Activate**.

The option indicator will turn into a green check mark to confirm that the option is now active.

Note: You can see the supported options in the **Options** list.

5. Tap **OK** to close the confirmation message, and then **Close** to exit.

Note: At this point, if you have used a USB key to copy your key file, you can remove it as it is not required to use your new options.

Installing Third-Party Software on Your Unit

The applications that can be installed on your unit depend on the operating system that it runs. The type of license differs from one operating to the other.



IMPORTANT

- ▶ **If your unit runs Microsoft Windows 10 IoT Enterprise:** You can install any third-party software, as long as it is used as a complementary tool to help you perform tests and measurements with your unit, or provides system utilities, resource management, or anti-virus or similar protection.
- ▶ **If your unit runs Microsoft Windows 8.1 Pro:** You can install any third-party software, as long as it is compatible with this operating system.
- ▶ **If your unit runs Windows Embedded 8 Standard:** To comply with the terms of the Microsoft license, you should only install antivirus software and the applications provided by EXFO.

In all cases, EXFO does not provide any support for the installation, use or troubleshooting of third-party software. Should you need help, refer to the corresponding third-party software documentation or technical support.

Protecting your Unit with an Antivirus Software

By default, your unit is protected with the Windows Defender antivirus software. However, you can apply your own security standards and antivirus strategy.

Getting Started with Your Unit

Securing your Unit Using the Kensington Lock

Securing your Unit Using the Kensington Lock

Your unit is equipped with a security slot to which you can connect an optional Kensington lock (security cable) to help prevent theft.

To secure your unit:

Connect your lock to the security slot located on the left panel of your unit.

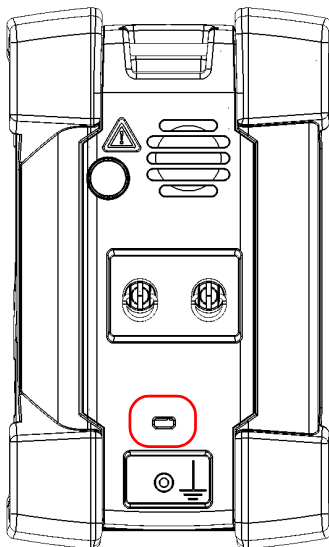

Using a Keyboard, Mouse or Other USB Devices

Your unit supports many USB devices. The table below gives an overview of the supported USB devices.

Device	Details
Memory key	For data transfer between your unit and a computer when you do not have access to a network. If you need information on how to transfer data using a memory key, see <i>Managing Data</i> on page 169.
Keyboard	When you are required to enter alphanumeric data, an on-screen (virtual) keyboard is displayed. However, if you prefer, you can use a hardware keyboard. Note: <i>Even if a keyboard is connected, the on-screen keyboard will still be displayed when you work in Toolbox X.</i>
Mouse	If you prefer to use a mouse instead of the touchscreen, you can connect one.
Composite device	You can use composite devices, that is devices that input information to your unit using more than one mean (for example, combinations of keyboard and mouse).
Hub	This device will be particularly useful to you if you need extra USB ports.
Printer	To print documents such as reports directly from you unit. If you prefer to use a network printer, you can also configure one. For more information, see <i>Configuring Network Printers</i> on page 104.

Getting Started with Your Unit

Using a Keyboard, Mouse or Other USB Devices

Device	Details
Mobile broadband USB modem key	To access the Internet without having to connect to a Wi-Fi or an Ethernet network. For more information, see <i>Accessing the Internet with a Mobile Broadband USB Modem Key</i> on page 149.
USB to RS-232 adapter (purchased from EXFO)	To be able to transfer data between your unit and a device only equipped with RS-232 (serial) ports. For more information, see <i>Using the USB to RS-232 Adapter</i> on page 181.

You can connect several devices at the same time.

To use a USB device with your unit:

Connect the USB device to any of the USB ports located on the right panel or on the top of the unit (see *Main Features* on page 1).

Note: *It is not necessary to turn off the unit before connecting the USB device. The software will automatically detect its presence.*

Your device is automatically recognized and immediately usable (provided that it uses the drivers already available on your unit).

Working with Bluetooth Devices

If you have purchased the RF (Wi-Fi and Bluetooth®) option, you can use many Bluetooth® devices with your unit.

With the supported Bluetooth® profiles, you can do the following:

- Use a wireless mouse and keyboard.
- Use a wireless headset.
- Print from your unit to a printer compatible with the Bluetooth® technology.
- Transfer files between your unit and a cell phone (see *Transferring Data Using the Bluetooth Technology* on page 171).
- Share files between your unit and computers compatible with the Bluetooth® technology (see *Transferring Data Using the Bluetooth Technology* on page 171).

4 **Setting Up Your Unit**

Adjusting Brightness

You may want to adjust the screen brightness yourself to better fit your work environment or preferences. Values are kept in memory even when you turn the unit off.

If you want to set the delay after which the display is dimmed to save power, see *Configuring the Power Management Options* on page 122.

To adjust the display brightness:

1. From the main window, tap the **System Settings** button.
2. Tap **Windows Mobility Center**.

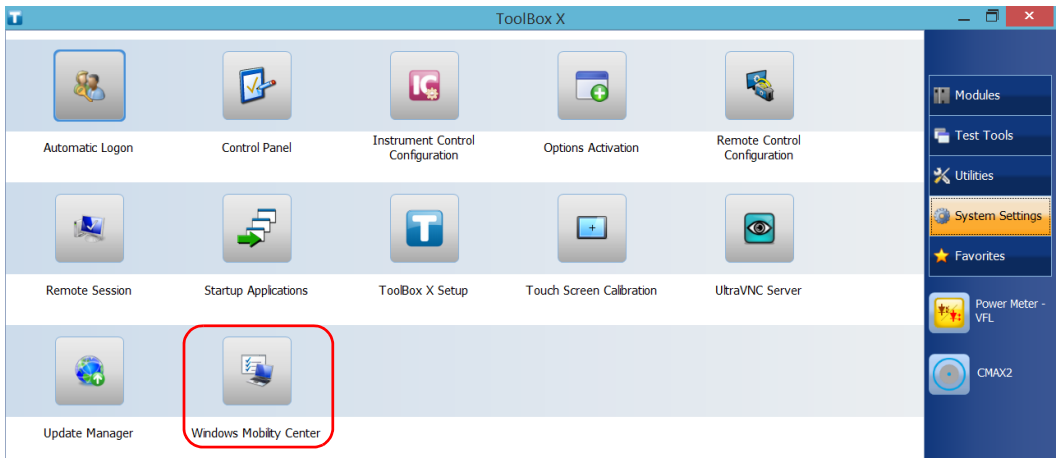

Setting Up Your Unit

Adjusting Brightness

3. Move the **Brightness** slider until the screen appearance is to your liking.

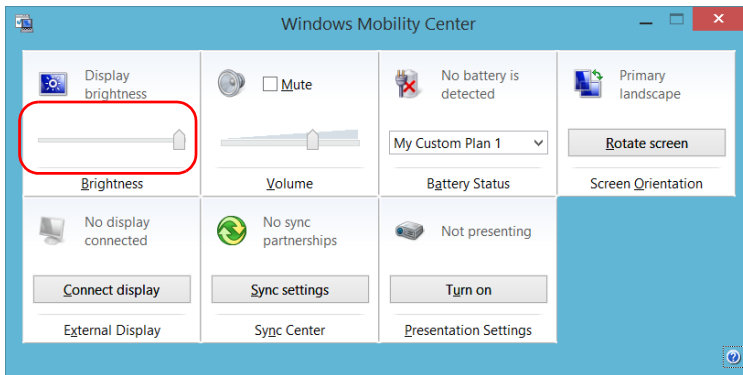

The new brightness value is taken into account immediately.

Adjusting Microphone and Speaker Volume

To fit your work environment, you may adjust the microphone and speaker (or headphones) volume. Values are kept in memory even when you turn the unit off.

To adjust microphone volume:

1. Ensure that your headset is connected to the audio port located on the top panel of the unit.

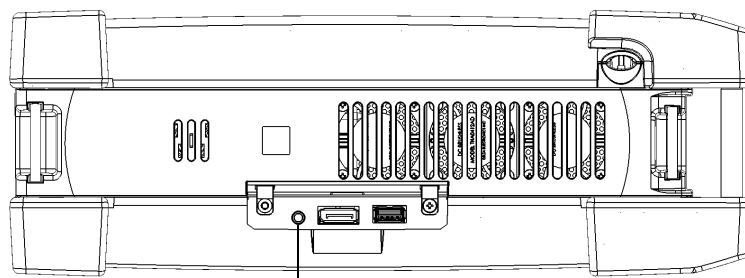

Headset/microphone port
(for 3.5 mm connector)

2. From the main window, tap the **System Settings** button.
3. Tap **Control Panel**.



Setting Up Your Unit

Adjusting Microphone and Speaker Volume

4. Tap **Hardware and Sound**.

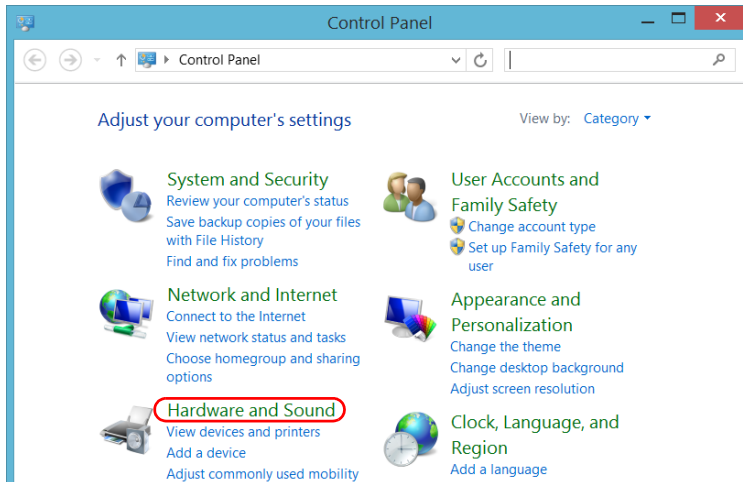

5. Under **Sound**, tap **Manage audio devices**.

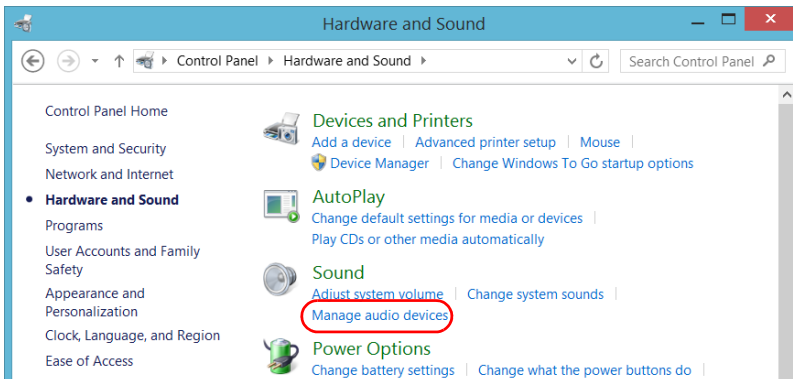

6. Select the **Recording** tab.
7. Ensure that your microphone is selected, and then tap **Properties**.

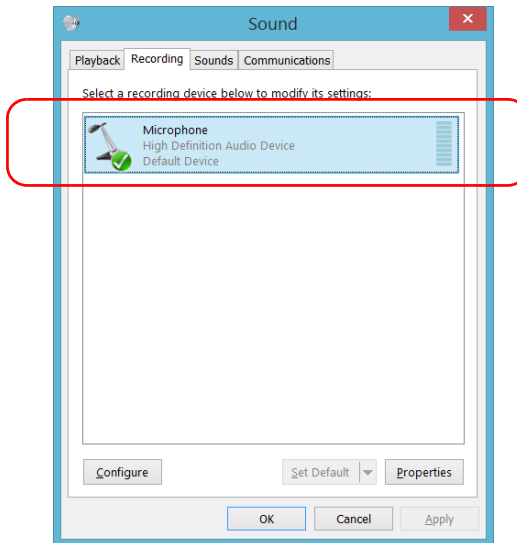

Setting Up Your Unit

Adjusting Microphone and Speaker Volume

- From the **Levels** tab, move the sliders until the settings are to your liking. If the sound coming from your microphone is too low, you may want to adjust the boost level as well.

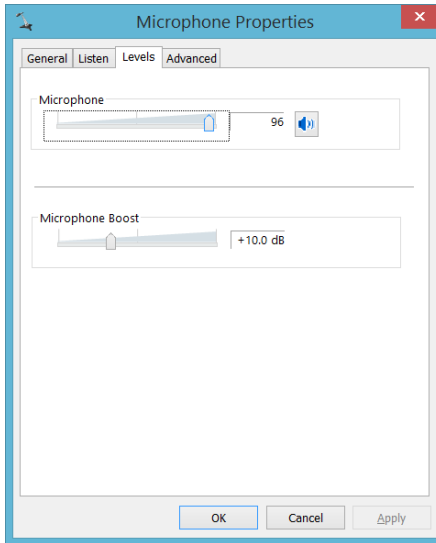

- Tap **OK** to confirm your new settings and close the window.
- Tap **OK** to close the window and return to Control Panel.

To adjust speaker (or headphones) volume:

- 1.** From the main window, tap the **System Settings** button.
- 2.** Tap **Windows Mobility Center**.

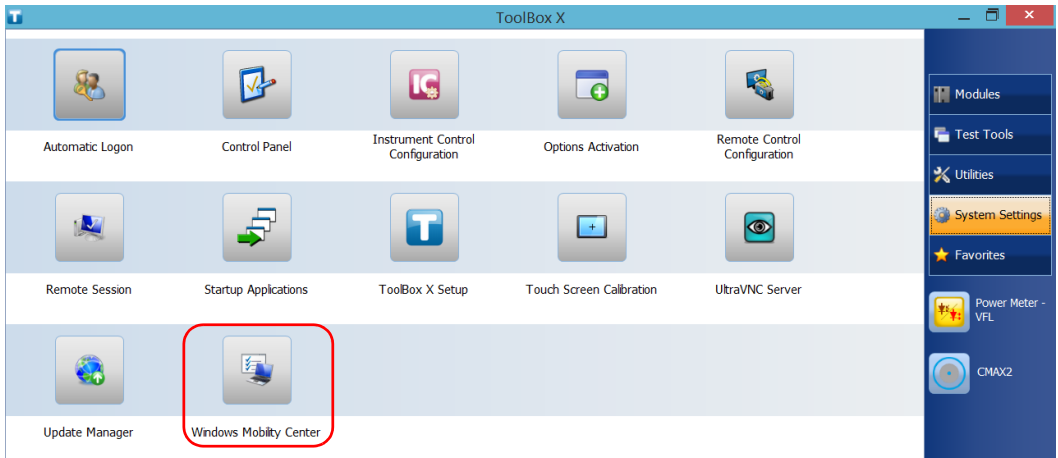

Setting Up Your Unit

Adjusting Microphone and Speaker Volume

3. Move the **Volume** slider until the sound level is to your liking.

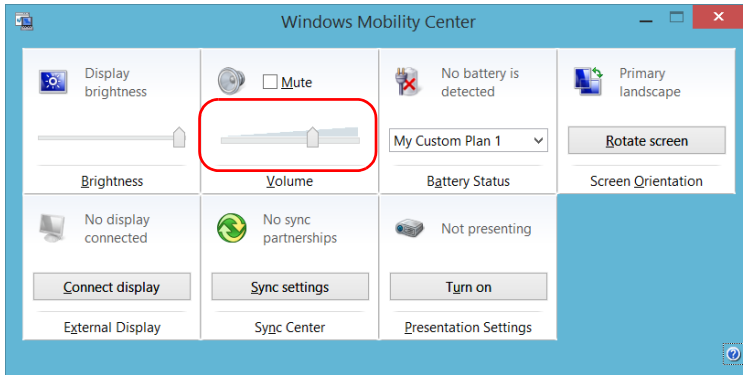

Note: You can also access the sound level slider by tapping the  icon from the taskbar.

The new value is taken into account immediately.

Recalibrating the Touchscreen

If you notice the touchscreen does not behave in the way it used to (for example, it is now difficult to select items) it probably needs a recalibration. You can perform a 4-point, 9-point (linearization), or even a 25-point (linearization) calibration. You can perform a 25-point linearization when you need more accuracy on screen edges and corners.

You can stop the calibration process at any time, but the touchscreen will still need calibration. The parameters are taken into account only when the process is complete.

Note: *If you have trouble accessing the touchscreen calibration feature because the touchscreen is not behaving as expected, you can connect a USB mouse.*



IMPORTANT

To get the optimum performance out of your touchscreen:

- Always use the calibration tool provided with ToolBox X (not the tool provided with Windows).
- Be as accurate as possible when you press the center of the targets that appear during touchscreen calibration. This will ensure a greater accuracy of the touchscreen, especially along the edges and in corners.

Setting Up Your Unit

Recalibrating the Touchscreen

To recalibrate the touchscreen:

1. From the main window, tap the **System Settings** button.
2. Tap **Touch Screen Calibration**.

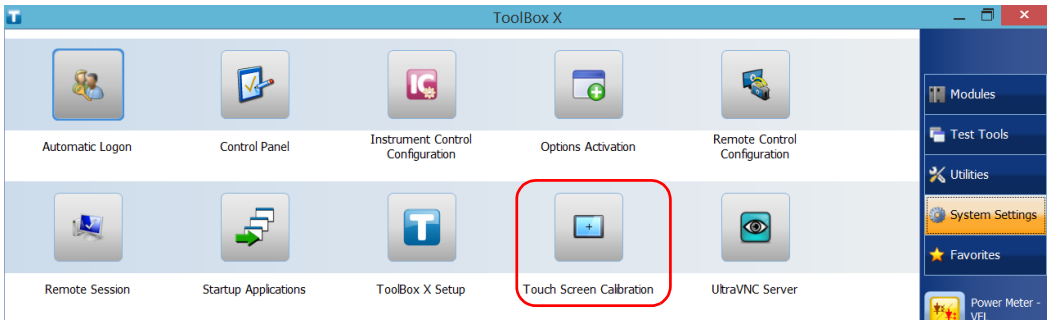

3. Tap the button corresponding to the type of calibration (or linearization) that you want to perform.

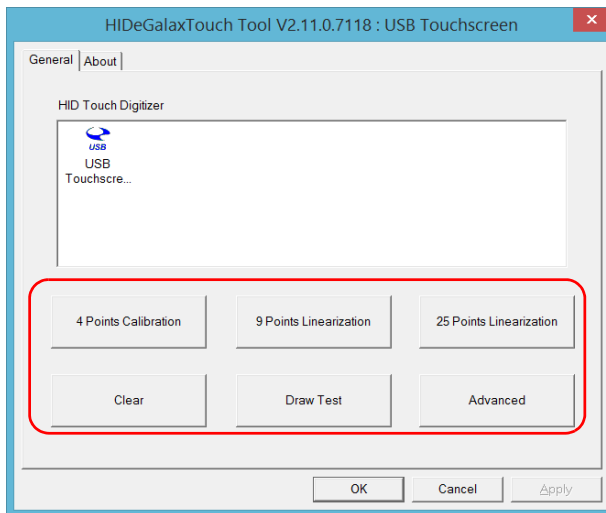

- Using the stylus (or any blunt pointing device), simply press the center of the different targets that appear on the screen. Keep pressing until the application displays **OK** to indicate that the new parameters have been taken into account.

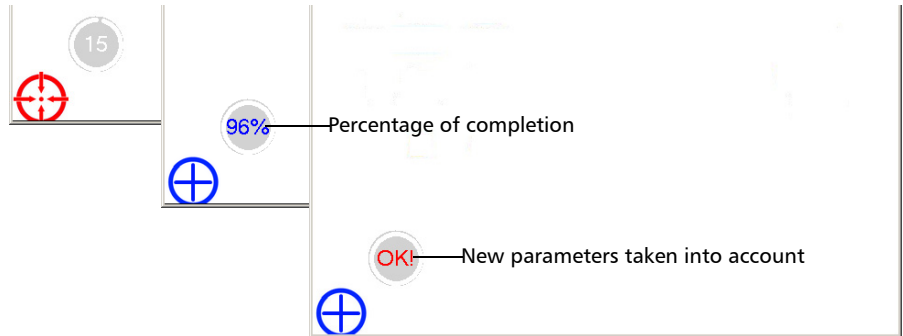

Note: *If you want to stop the calibration process, stop pressing the screen. The application will close automatically after a few seconds and you will return to the **System Settings** window.*

- When you see the message indicating that the calibration is complete, tap **OK** to return to the **System Settings** window.

Setting Up Your Unit

Customizing the Right-Click Feature

Customizing the Right-Click Feature

By default, you can perform a “press and hold” action which corresponds to right-clicking with your touchscreen (see *Right-Clicking with the Touchscreen* on page 70). However, you can disable this feature if you prefer.

You can also modify the delay before the unit considers that you are right-clicking, as well as the amount of time before displaying the shortcut menu once you have right-clicked.

To customize the right-click feature:

1. From the main window, tap the **System Settings** button.
2. Tap **Control Panel**.



3. Tap **Hardware and Sound**.

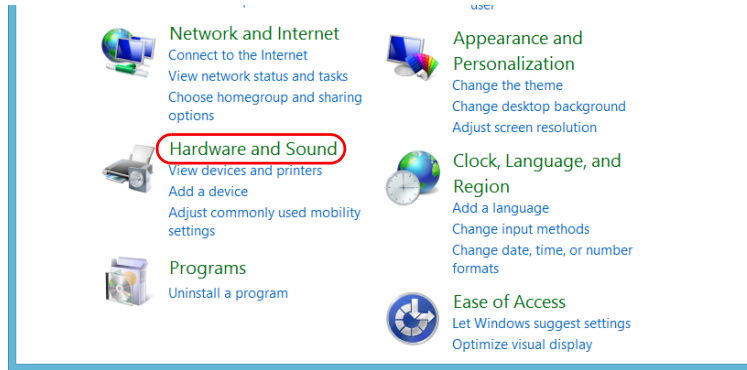

4. Tap **Pen and Touch**.

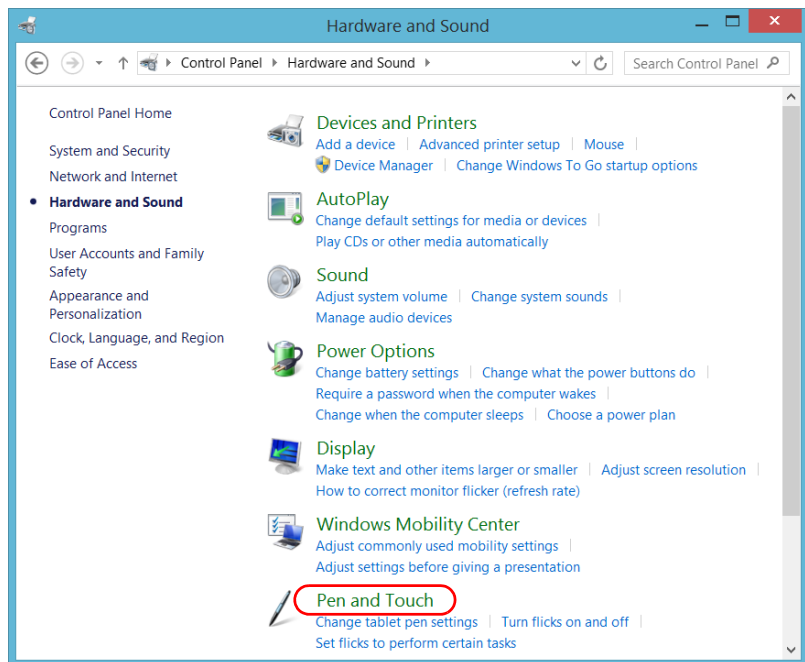

Setting Up Your Unit

Customizing the Right-Click Feature

5. From the list, select **Press and hold**.

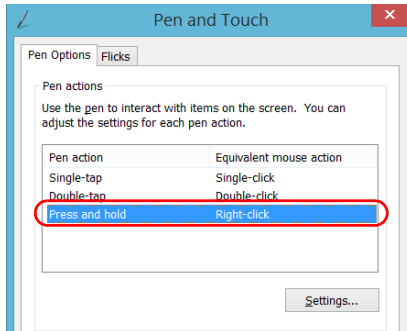

6. Tap **Settings**.
7. If you want to use the right-click feature with your unit, select the **Enable press and hold for right-clicking** check box. Clear the check box if you prefer not to use this feature.

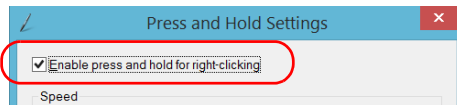

8. If you want to modify the response time of the right-click, move the **Speed** or **Duration** sliders to adjust the configuration to your needs.

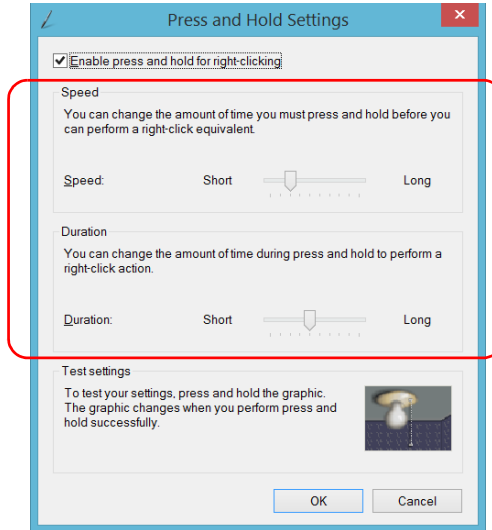

9. Tap **OK** to confirm your changes.

Enabling or Disabling the Automatic Logon

Note: Only administrator-level users can enable or disable the automatic logon feature.

You can configure your unit to automatically log on to Windows at startup (no need to select a user and enter a password). You can also disable this feature if you prefer to define separate user accounts with different user access rights and passwords.

Note: For security reasons, when the unit comes back from sleep mode, the application will prompt you to select a user and enter a password, even if you have enabled the automatic logon feature.

Also for security reasons, by default, the automatic logon is not enabled. Once it is enabled, if you want to modify the password of the user account for which the automatic logon is enabled, you will have to disable the feature first, and then enable it again once the new password is defined.

If you want to modify the account used for the automatic logon, you will also have to disable the feature first, and then enable it again for the new account.



IMPORTANT

The user name and password that you specify for the automatic logon must correspond to those of an existing user account. You can create user accounts or modify passwords from the Accounts window.

- ▶ In Windows 10: Start button > Settings > Accounts.
- ▶ In Windows Embedded 8 Standard: Charm bar > Settings > Change PC settings > Users.
- ▶ In Windows 8.1 Pro: Charm bar > Settings > Change PC settings > Accounts).

To enable the automatic logon:

1. From the main window, tap the **System Settings** button.
2. Tap **Automatic Logon**.



3. From the User Accounts window, clear the **Users must enter a user name and password to use this computer** check box.



4. Tap **OK** to confirm.

Setting Up Your Unit

Enabling or Disabling the Automatic Logon

5. Enter the desired user name (account) and the corresponding password.

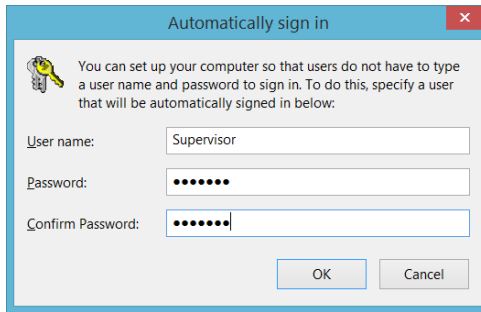

6. Tap **OK** to confirm and to return the **System Settings** window.

At next startup, you will no longer need to specify a user name and password (except if the unit comes back from sleep mode).

To disable the automatic logon:

1. From the main window, tap the **System Settings** button.
2. Tap **Automatic Logon**.



3. From the User Accounts window, select the **Users must enter a user name and password to use this computer** check box.

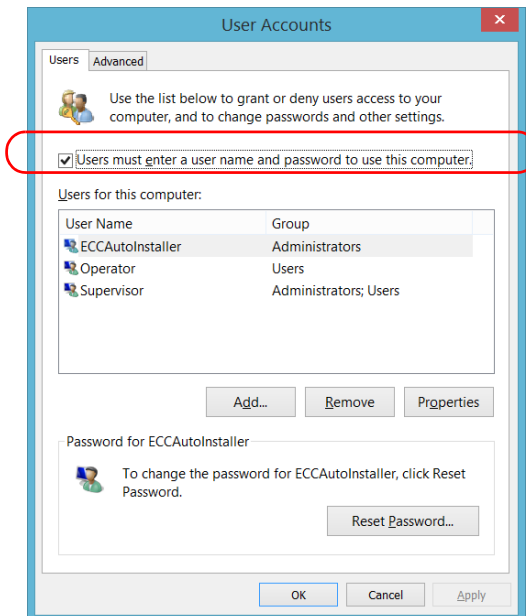

4. Tap **OK** to confirm and to return the **System Settings** window.
At next startup, you will have to specify the user name and password.

Setting Up Your Unit

Selecting the Startup Applications

Selecting the Startup Applications

The first time you start your unit, Toolbox X is displayed. You can configure your unit to automatically start any of the available applications as soon as ToolBox X is started. This can save you time, as you do not need to ensure that they are already running before starting your tests.

If the required module is not present in the unit, the specified applications will simply not be started. In some cases, you may have to select the applications again the next time the module is inserted into the unit.

To set applications to start automatically at ToolBox X startup:

1. From the main window, tap the **System Settings** button.
2. Tap **Startup Applications**.

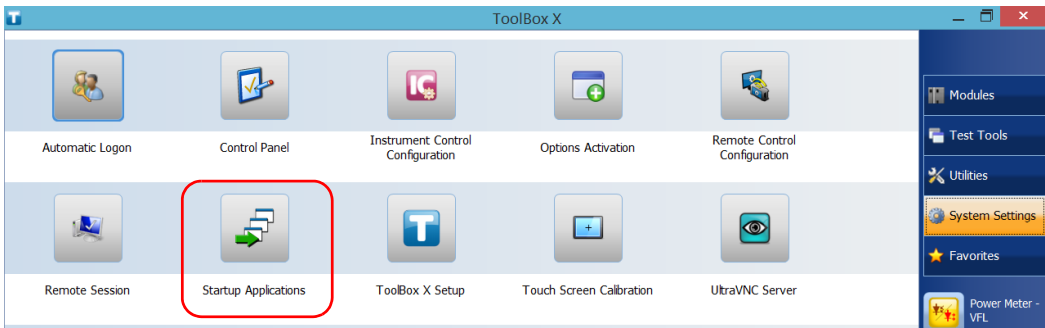

3. Under **Module Applications** or **Other Applications**, select the applications you want to start automatically by selecting the corresponding check boxes.

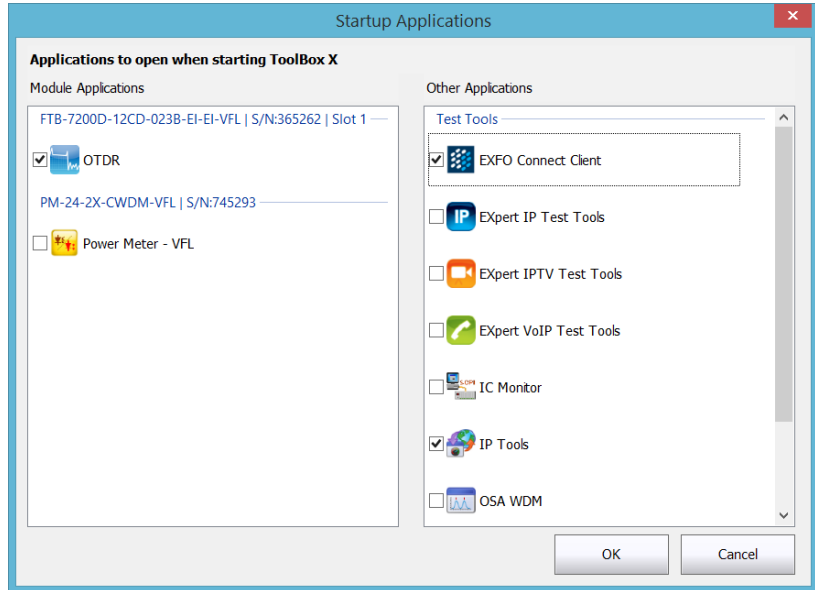

4. Tap **OK** to use the new settings. Tap **Cancel** to exit without using the new settings.

Note: *The new settings will be taken into account the next time ToolBox X is started.*

Configuring Network Printers

Your unit supports both (local) USB and network printers (you may have to install specific drivers on your unit).

For more information on USB printers connection, see *Using a Keyboard, Mouse or Other USB Devices* on page 79.

To print documents and images on a network printer, you must configure the printer first. You must know the IP address of the network printer that you want to configure, and ensure that your unit is connected to the same network as the printer (either wireless or Ethernet connection). Contact your network administrator for more information on your specific network configuration.

For more information on printing, see *Printing Documents* on page 145.

To configure the printer:

1. From the main window, tap the **System Settings** button.
2. Tap **Control Panel**.

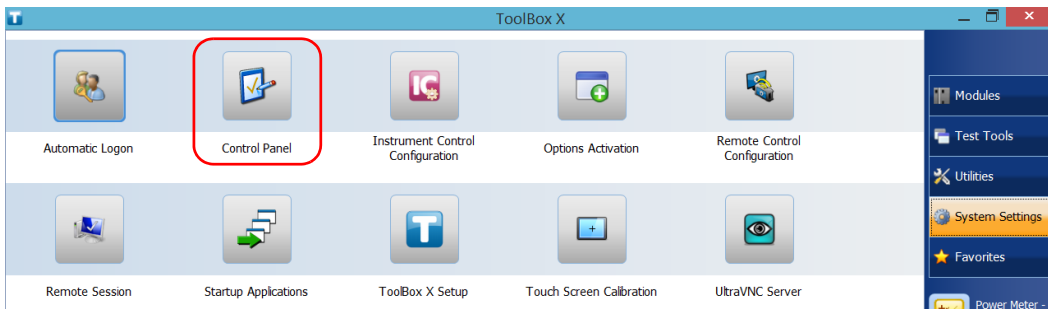

3. Under **Hardware and Sound**, tap **View devices and printers**.

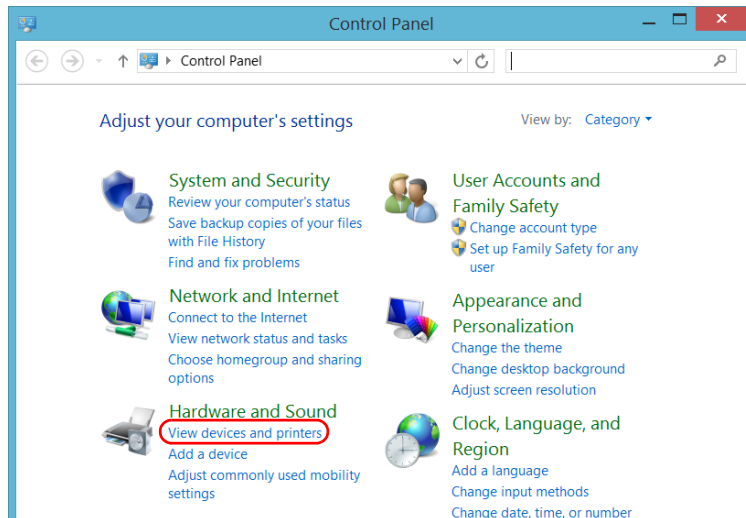

4. Tap **Add a printer**.

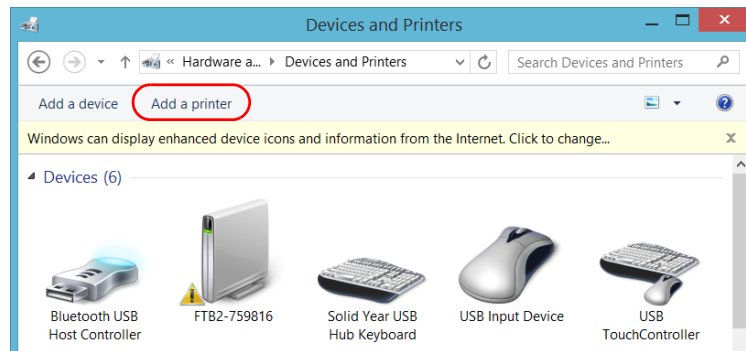

5. Follow the on-screen instructions.

Setting Up Your Unit

Selecting the Language of Operation

Selecting the Language of Operation

You may display the user interface in one of the available languages.

The availability of the languages is function of the language group that was installed on your unit at time of purchase. It is possible to download language packs from the Microsoft Website to add extra languages if necessary.

The ToolBox X application is offered in several languages. This means that if ToolBox X supports the language currently selected in Windows, it will automatically be displayed in this language. If the selected language is not supported, the English version will be used.

When you change the interface language, the corresponding keyboard is automatically added to the list of available keyboards. You can then enter text in a specific language (both on-screen or “real” keyboards). Once the keyboards are added, you can switch easily from one input language to another.

Values are kept in memory even when you turn the unit off.

To select a new interface language:

1. From the main window, tap the **System Settings** button.
2. Tap **Control Panel**.



Setting Up Your Unit

Selecting the Language of Operation

3. Under **Clock, Language, and Region**, tap **Add a language**.

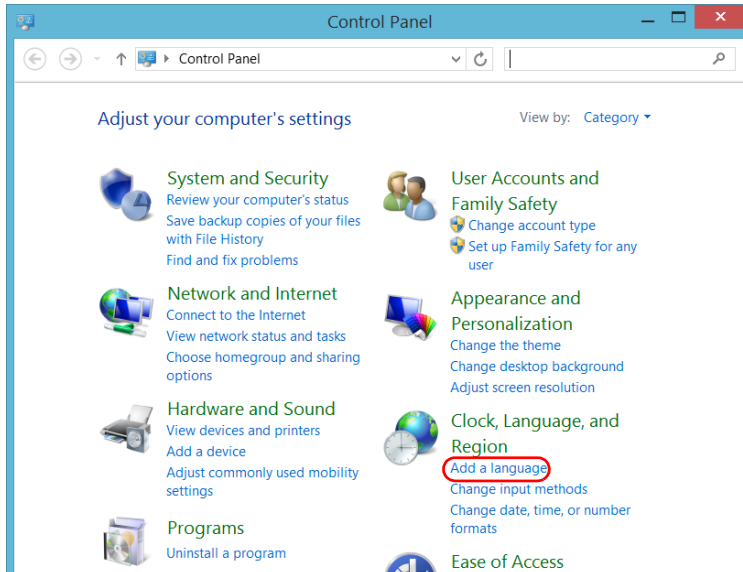

4. Select the desired language from the list.

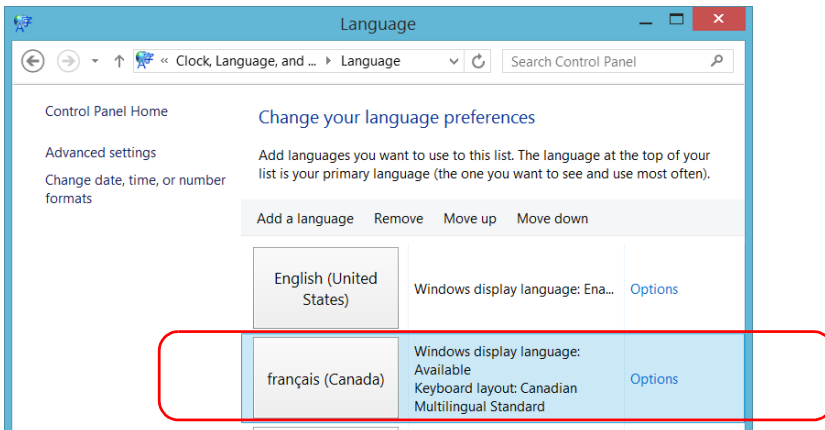

5. Tap **Options**.

6. If you want to select another keyboard layout than the one that has been added by default, proceed as follows.

6a. Under **Input method**, tap **Add an input method**.

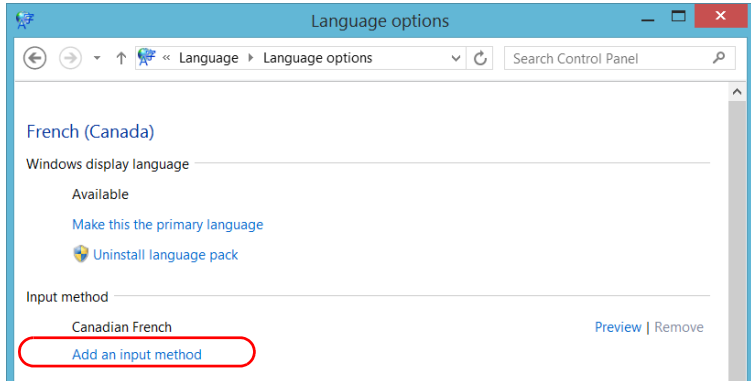

6b. Select the desired keyboard layout, and then tap **Add**.

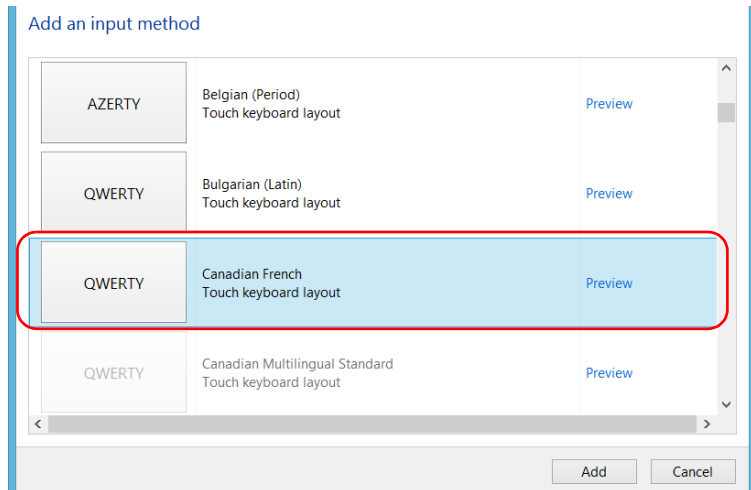

Setting Up Your Unit

Selecting the Language of Operation

7. Under **Windows display language**, tap **Make this the primary language**.

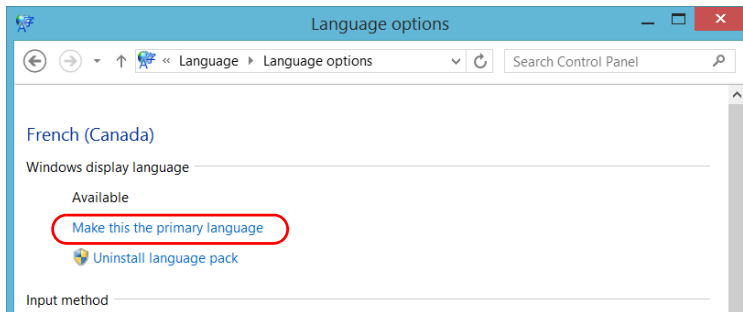

8. When the application prompts you to log off, tap **Log off now**.
9. Once you see the lock screen, swipe it down to reveal the user accounts.
10. Log to your user account.

The new language is now selected and you are able to switch from one input language to another.



IMPORTANT

In Windows Embedded 8 Standard, when you select a language that you have installed manually, the Windows interfaces do not switch to the selected language. They remain in the language configured at time of purchase. However, the EXFO applications are displayed in the selected language (when available).

To switch from one of the available input languages to another:

1. From the taskbar, tap the language code to display the list of available input languages.

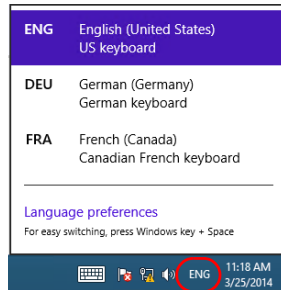

Language code

2. From the list of languages, select the desired one.

You are now ready to start entering text in the selected input language.

Note: *Modifying the input language does not modify the language of the interface.*

Setting Up Your Unit

Selecting the Language of Operation

To download language packs:

1. Ensure that your unit has access to the Internet.
2. From the main window, tap the **System Settings** button.
3. Tap **Control Panel**.

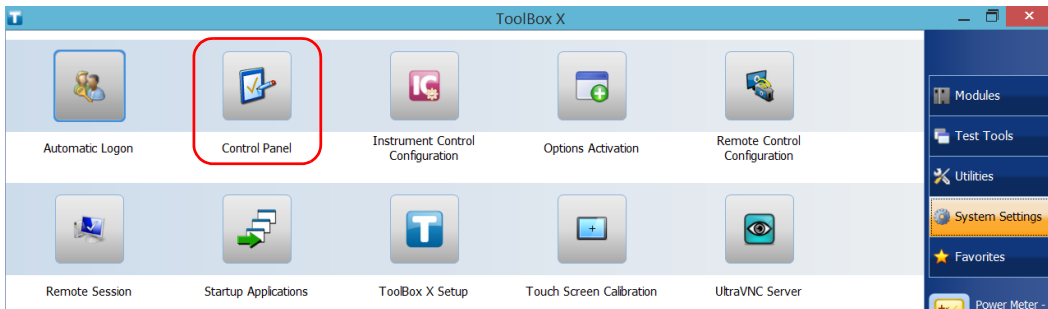

4. Under Clock, Language, and Region, tap Add a language.

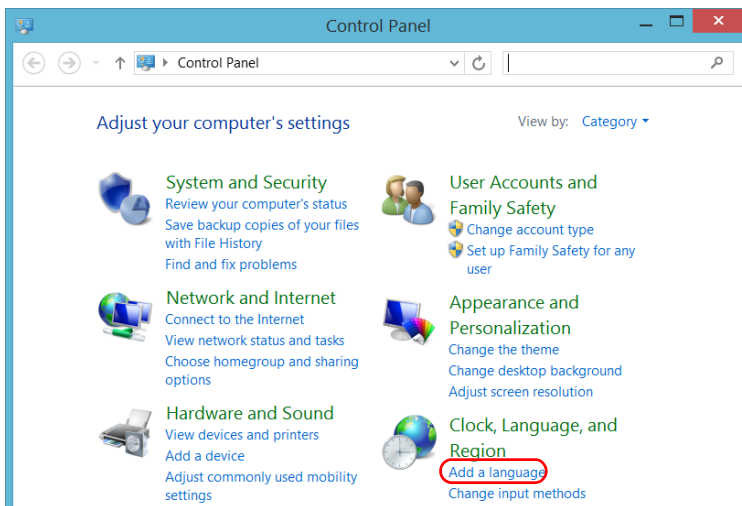

5. Tap Add a language.

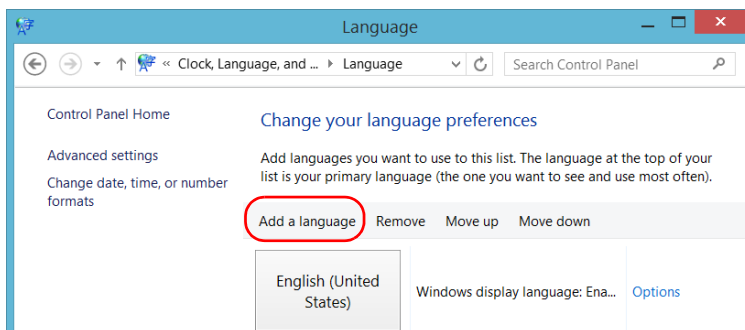

Setting Up Your Unit

Selecting the Language of Operation

6. Browse the list of languages, and then select the one that you want to use.

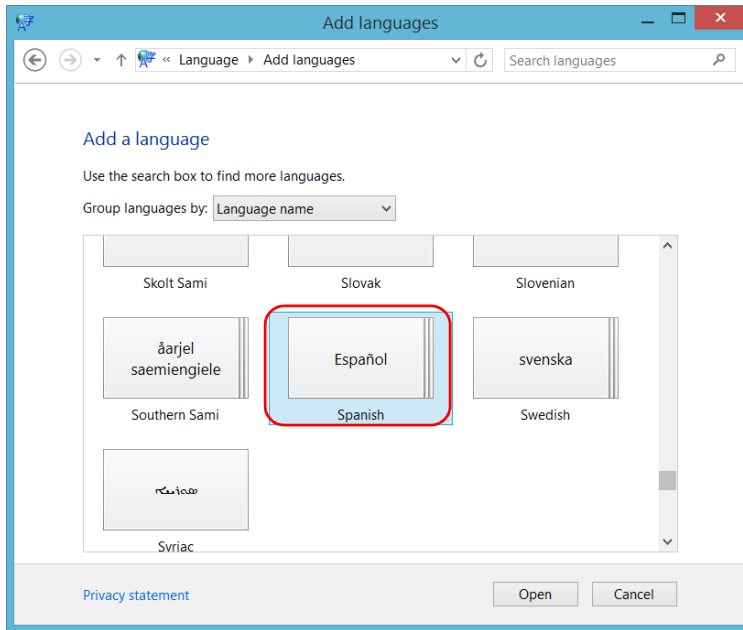

7. Tap **Open** to access the list of sub-languages.

8. Select the desired sub-language, and then tap Add.

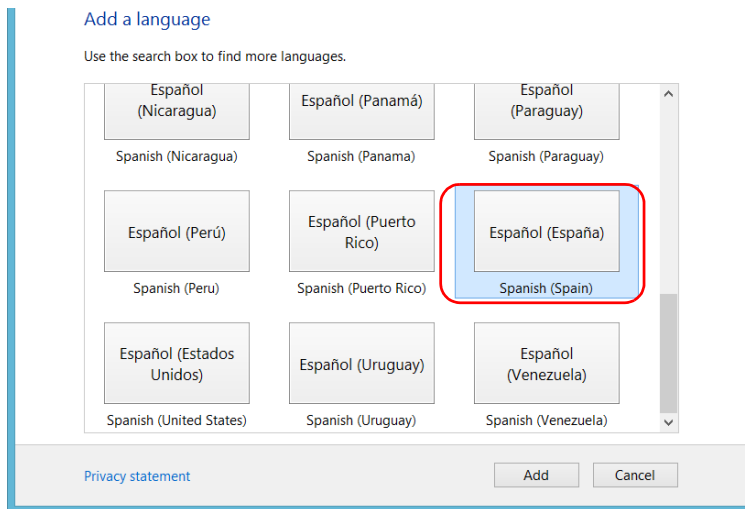

9. Select the desired language from the list.

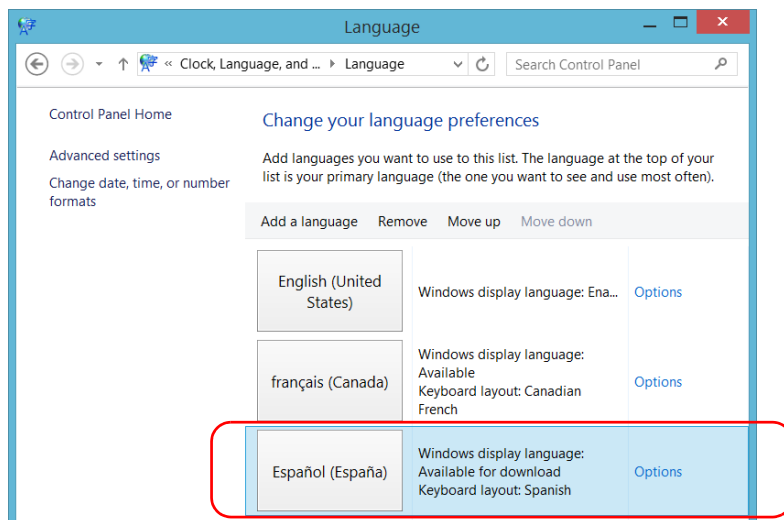

10. Tap Options.

Setting Up Your Unit

Selecting the Language of Operation

11. Tap Download and install language pack.

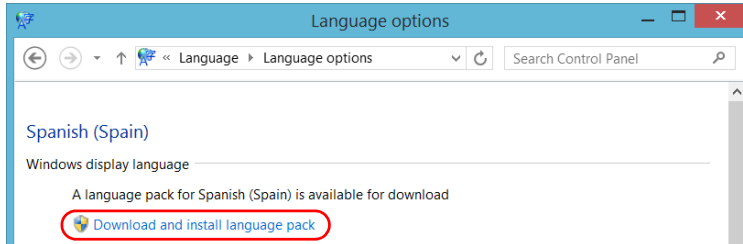

- 12.** When the application prompts you to allow the installation, tap **Yes**.
The installation may take a few minutes.
- 13.** When the installation is complete, restart your unit.

Setting Date and Time Formats

By default, the dates (short and long) and time are displayed in the formats associated with the global language format (locale). The time can be expressed with a 12- or a 24-hour notation. You can modify the way dates and time are displayed if the default values do not suit your needs.

For information on how to adjust the date, the time, and the time zone, see *Adjusting the Date, Time and Time Zone* on page 119.

To set date and time formats:

1. From the main window, tap the **System Settings** button.
2. Tap **Control Panel**.

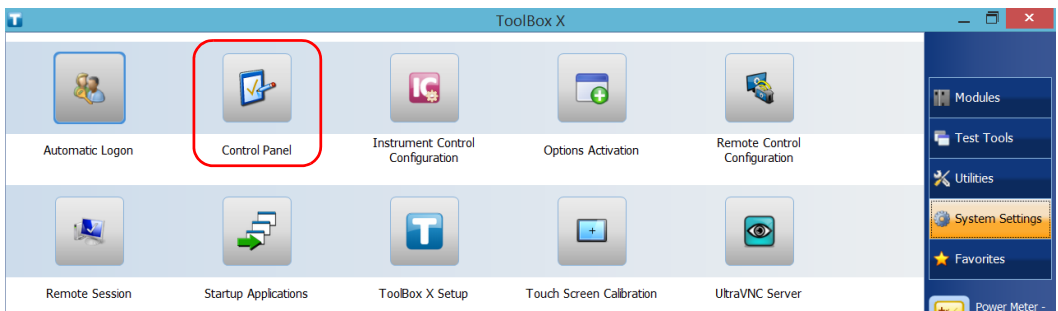

Setting Up Your Unit

Setting Date and Time Formats

3. Under **Clock, Language, and Region**, tap **Change date, time, or number formats**.

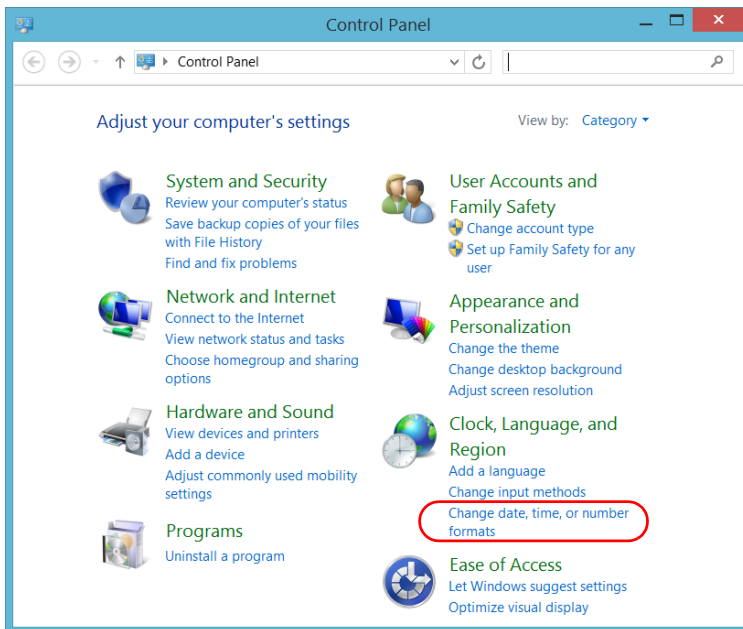

4. Refine the settings according to your needs.
5. Tap **Apply** to confirm, and then **OK** to close the window.

The new values are taken into account immediately.

Adjusting the Date, Time and Time Zone

Note: Only administrator-level users can adjust the date and time. All users can modify the time zone.

The current date and time are displayed at the bottom of the main window. When saving results, the unit also saves the corresponding date and time.

For information on how to modify the format in which the date and time are displayed, see *Setting Date and Time Formats* on page 117.

To adjust the date, time or time zone:

1. From the main window, tap the **System Settings** button.
2. Tap **Control Panel**.



Setting Up Your Unit

Adjusting the Date, Time and Time Zone

3. Tap Clock, Language, and Region.

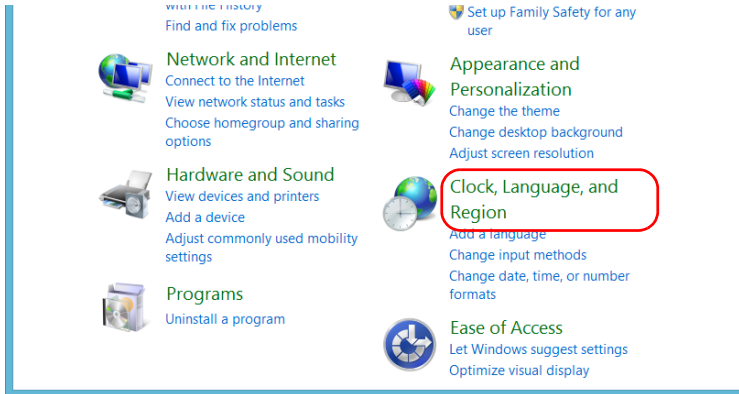

4. Under **Date and Time**, tap **Set the time and date**.

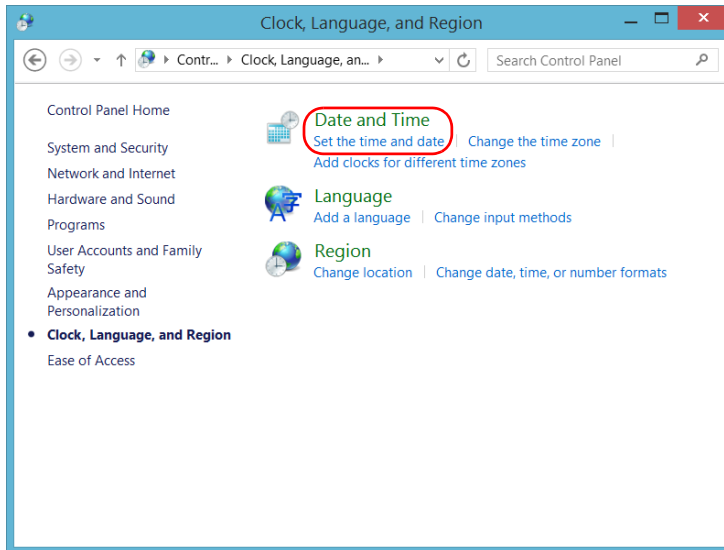

5. Tap **Change date and time** or **Change time zone**, depending on the settings that you want to modify.

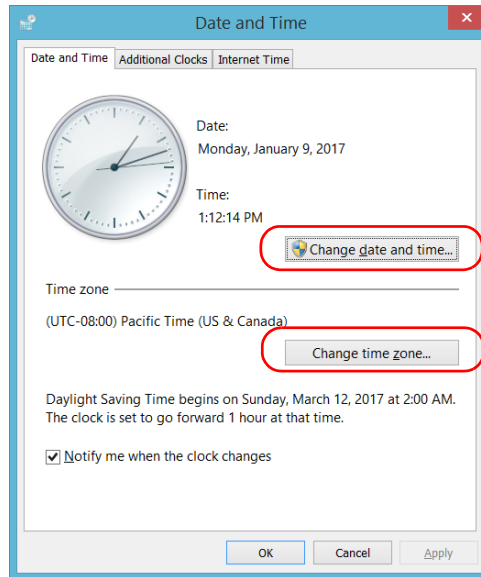

6. Modify the settings according to your needs, and then tap **OK**.
 7. Tap **Apply** to confirm, and then **OK** to close the window.
- The new values are taken into account immediately.

Setting Up Your Unit

Configuring the Power Management Options

Configuring the Power Management Options

To help you get the optimum performance out of your unit, it comes with predefined sets of parameters (plans) to manage power.

When you do not use the unit for a while, the display may be dimmed or turned off to save power. You can also configure the unit to go into sleep mode after the specified duration has expired (see *Turning Off Your Unit* on page 57).

For all of these actions, you can set idle durations for AC adapter/charger (or power cord) and battery operation. The values that you set are kept in memory even when you turn the unit off.

Note: When the backlight is turned off and the  LED is lit and not blinking, the unit operation is not interrupted. Touch anywhere on the screen to return to normal operation.

The table below identifies the predefined power plans.

Power Plan	Characteristics
Balanced (selected by default)	Provides extra power when your unit needs it, and saves power when your unit consumes less.
High Performance	Provides maximum power, which could be particularly useful when you intend to work modules requiring extra power.
Power Saver	Optimizes the energy consumption, which could be particularly useful when you operate the unit on batteries.

You can either modify one of the existing power plans or create one (based on an existing power plan). It is always possible to revert to factory default values for the predefined plans. You can delete custom power plans that you no longer use, but not the predefined plans.

To select a power plan:

1. From the main window, tap the **System Settings** button.
2. Tap **Control Panel**.



3. Tap **Hardware and Sound > Power Options**.

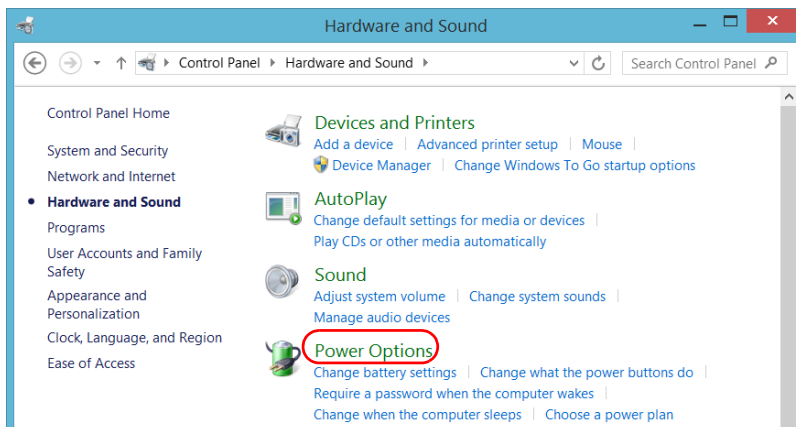

Setting Up Your Unit

Configuring the Power Management Options

4. If necessary, tap **Change settings that are currently unavailable**.

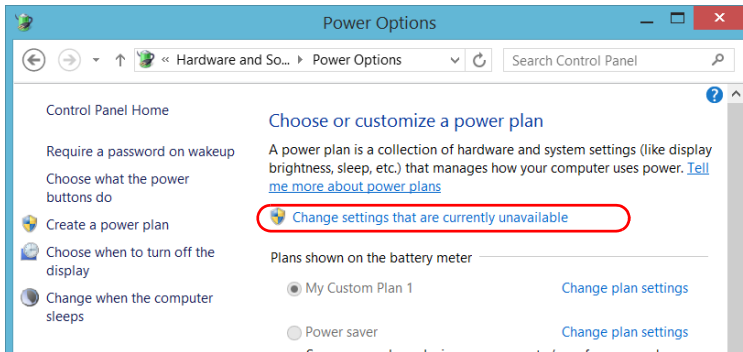

5. From the list of available power plans, select the desired set of parameters.

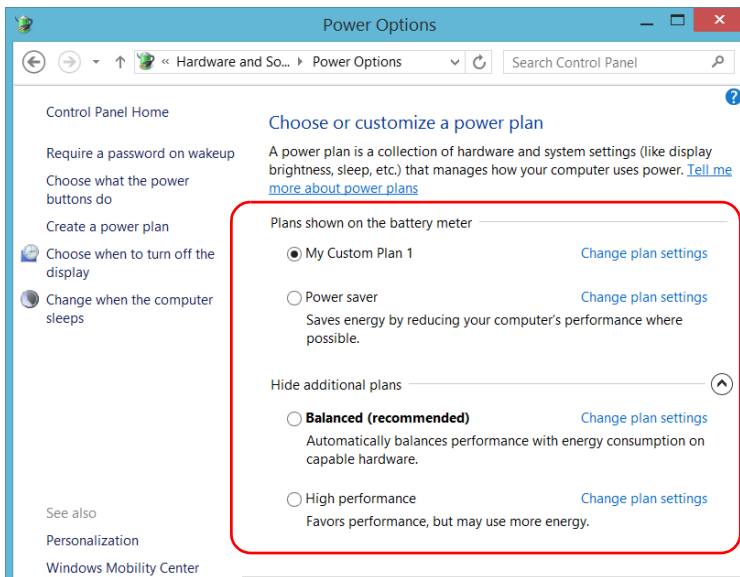

6. Close the window.

The new values are taken into account immediately.

To create a power plan:

1. From the main window, tap the **System Settings** button.
2. Tap **Control Panel**.



3. Tap **Hardware and Sound > Power Options**.

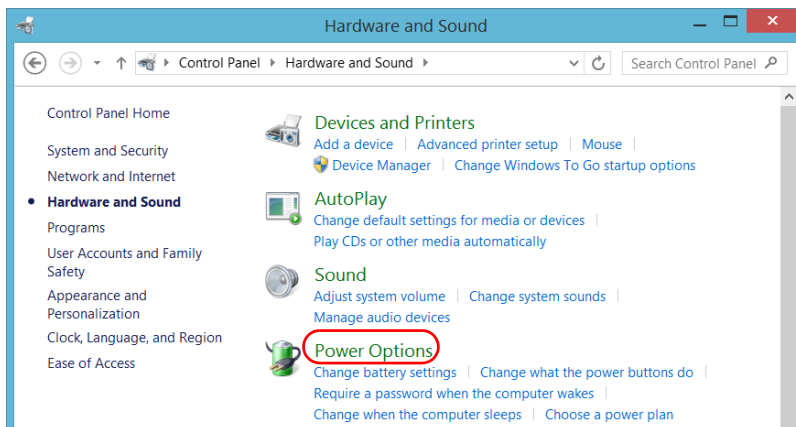

Setting Up Your Unit

Configuring the Power Management Options

- From the list on the left, tap **Create a power plan**.

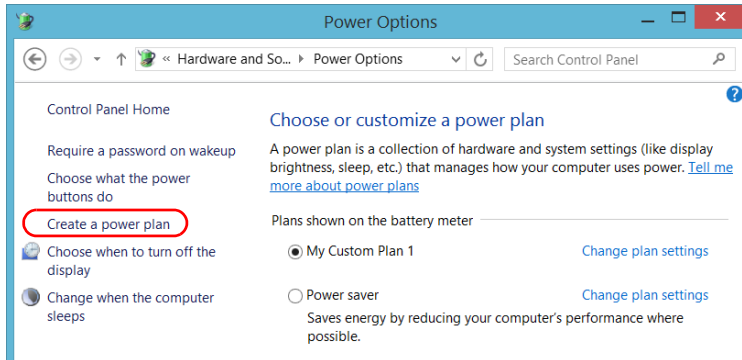

- Select a power plan that will serve as a basis.

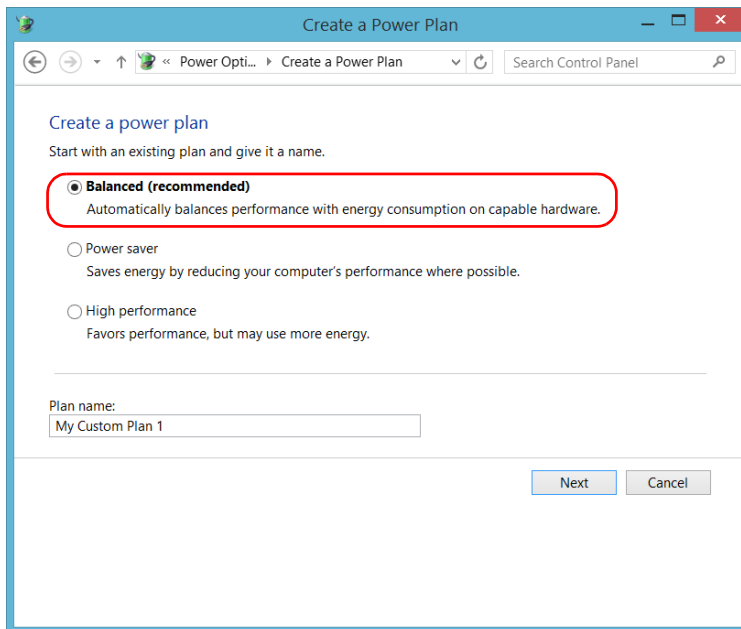

- Enter a name, and then tap **Next**.

7. Modify the parameters to suit your needs.

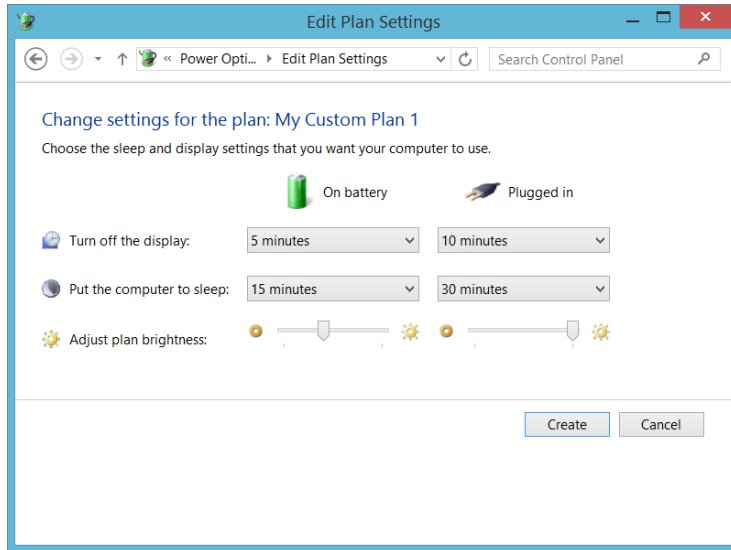

8. Tap **Create**.

Setting Up Your Unit

Configuring the Power Management Options

To modify or delete an existing power plan:

1. From the main window, tap the **System Settings** button.
2. Tap **Control Panel**.

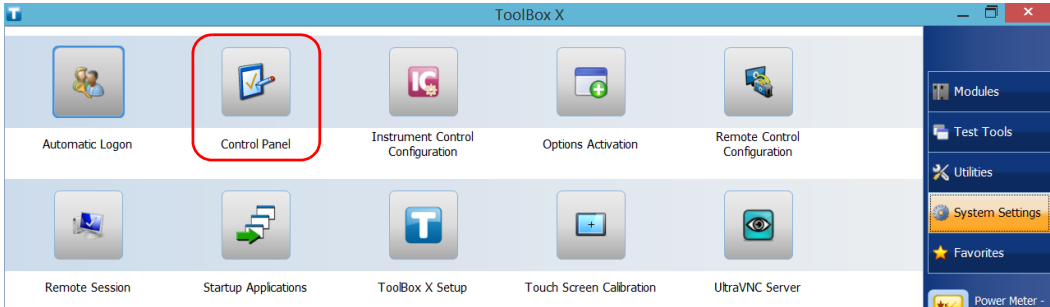

3. Tap **Hardware and Sound > Power Options**.

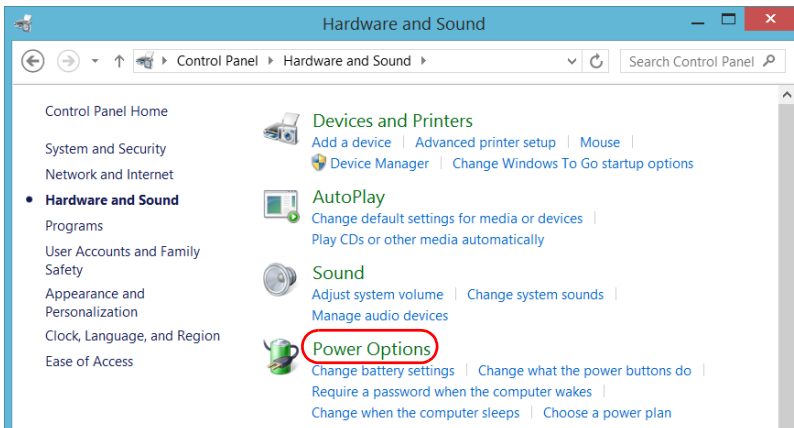

4. From the list of available power plans, locate the set of parameters that you want to modify or delete.

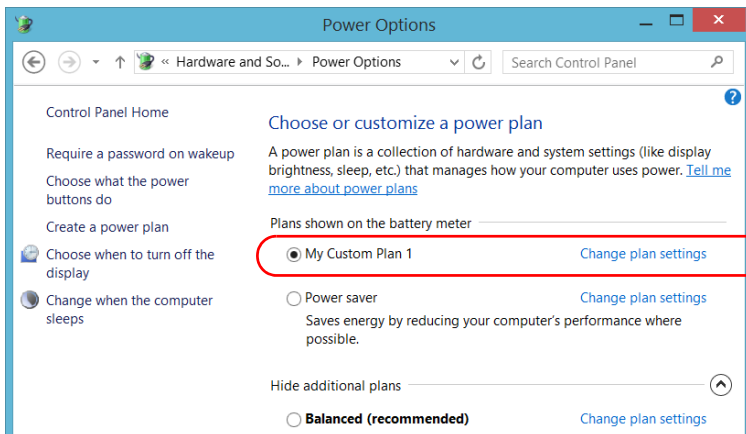

Note: *You can only delete custom power plans, not predefined ones. If the custom power plan that you want to delete is currently in use, you must select another plan first.*

5. Tap **Change plan settings** (appearing next to the power plan).

Setting Up Your Unit

Configuring the Power Management Options

6. If you want to modify the parameters, proceed as follows:
 - 6a. If necessary, tap **Change settings that are currently unavailable**.

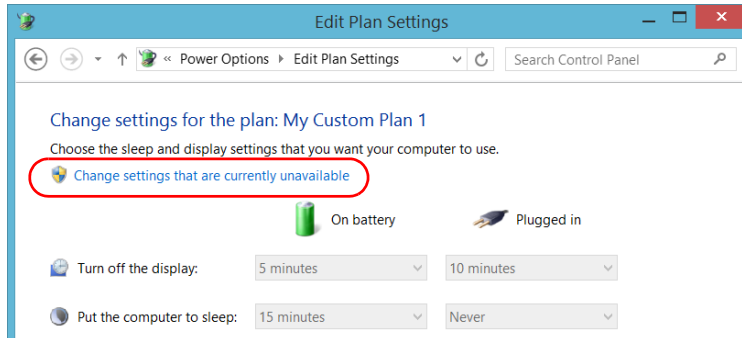

- 6b. Modify the parameters to your needs.

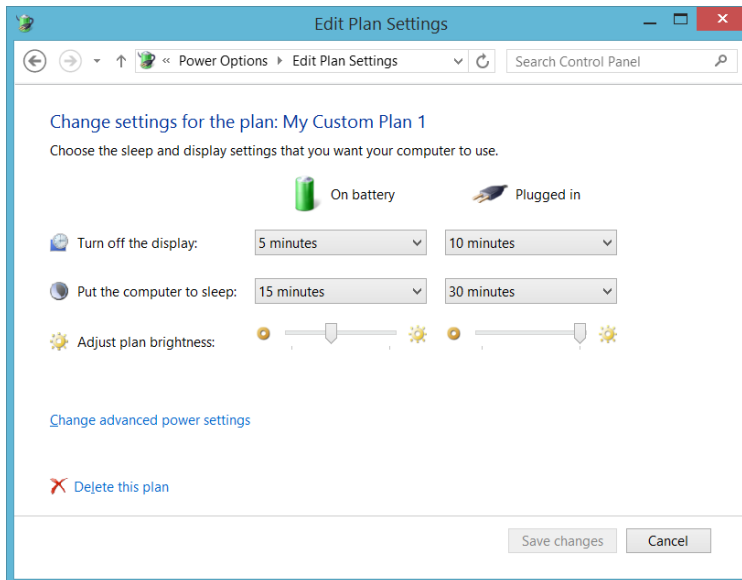

- 6c. Tap **Save changes**.

7. If you want to delete the power plan, tap **Delete this plan**, and then confirm the deletion.

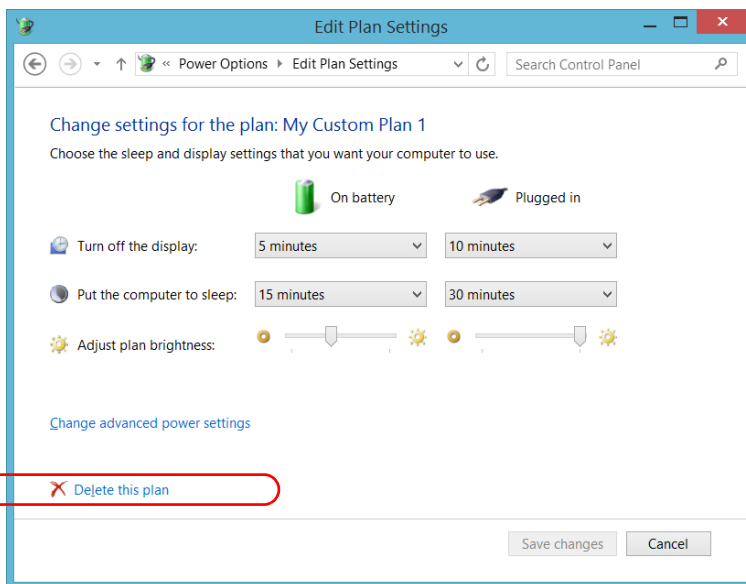

8. Close the window.

The changes are taken into account immediately.

Setting Up Your Unit

Setting ToolBox X Behavior

Setting ToolBox X Behavior

You can specify how ToolBox X behaves when the application is started, minimized or closed.

To set the ToolBox X behavior:

1. From the main window, tap the **System Settings** button.
2. Tap **ToolBox X Setup**.

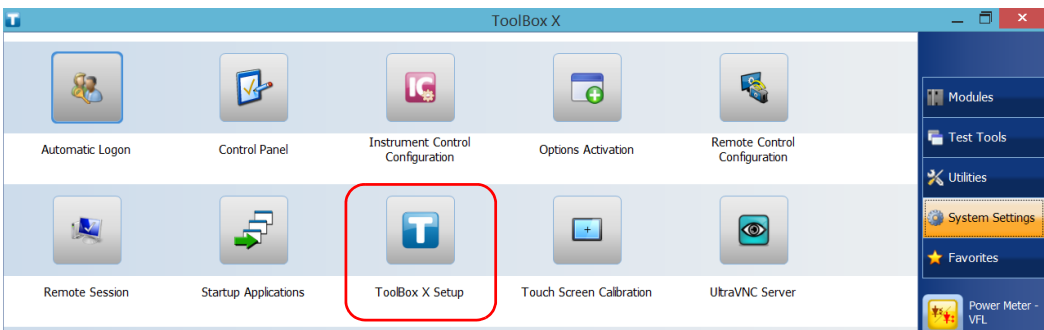

3. Select the items corresponding to the desired behavior.

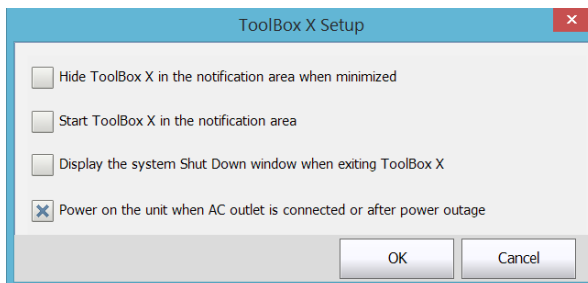

- **Hide ToolBox X in the notification area when minimized:** If this option is selected, the ToolBox X icon appears in the notification area (where the clock is located) when you minimize the window.
 - **Start ToolBox X in the notification area:** If this option is selected, ToolBox X is automatically started, then minimized to the notification area (system tray).
 - **Display the system Shut Down window when exiting ToolBox X:** If this option is selected, the standard system Shut Down window appears to let you shut down the unit directly instead of closing the ToolBox X application, then shutting down the unit from Windows. For more information on the different ways to turn off your unit, see *Turning Off Your Unit* on page 57.
4. Tap **OK** to confirm your settings and close the window.

Setting Up Your Unit

Configuring the Internet Options

Configuring the Internet Options

You can browse the Web directly from your unit, provided that you have access to an Internet connection and that the Internet options are configured properly.

If you are not sure about how you should configure your Internet access, contact your network administrator.

To configure the Internet options:

1. From the main window, tap the **System Settings** button.
2. Tap **Control Panel**.

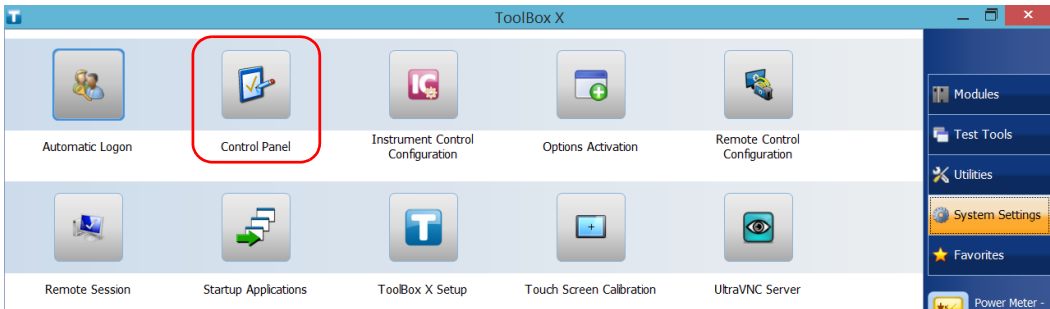

3. Tap Network and Internet.

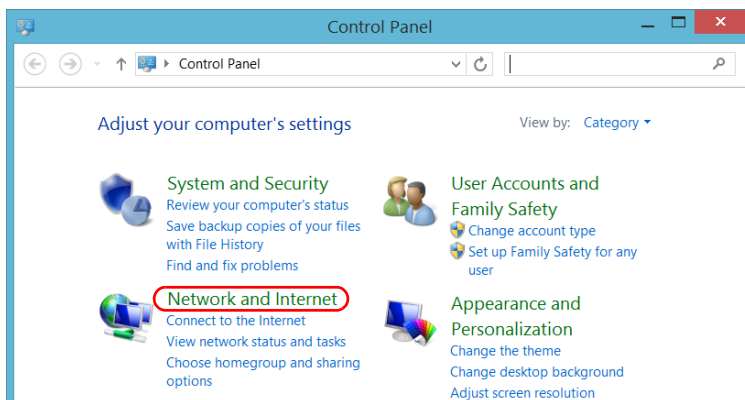

4. Tap Internet Options.

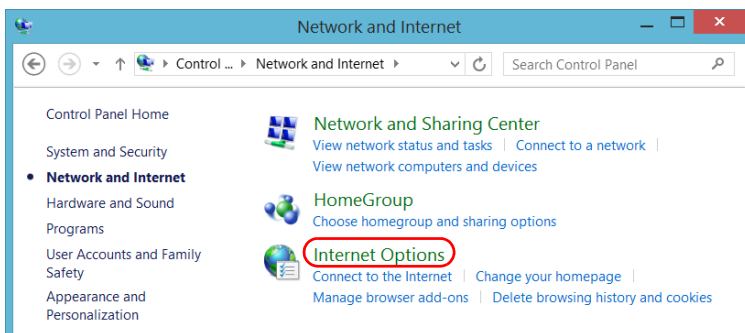

Setting Up Your Unit

Configuring the Internet Options

5. Go to the **Connections** tab.

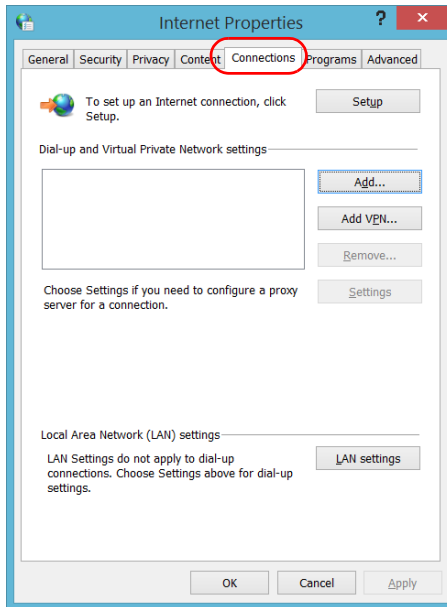

6. Modify the settings using the information provided by your network administrator.
7. Tap **OK** to return to the **Control Panel** window.

Getting Ready to Retrieve Geolocation Information

With your unit and a smart device properly configured, you can retrieve geolocation information (latitude and longitude coordinates) to identify the position of your unit. This geolocation information can then be saved along with test results, or viewed in the GPS Coordinates Viewer (see *Retrieving the GPS Location of Your Unit* on page 151).

Note: *Some applications may not save geolocation information along with test results.*

During the configuration of the smart device, you will create a mobile wireless hotspot onto which your unit will connect to retrieve the geolocation information.

Note: *Normally, you would only need to configure your unit and smart device the first time you want to retrieve geolocation information. Your subsequent work sessions would require a simple connection.*



IMPORTANT

- Your unit must be equipped with the RF (Wi-Fi) option.
- To be able to create a mobile wireless hotspot on your smart device, you may have to subscribe to a data plan. Contact your mobile service provider for more information.

Setting Up Your Unit

Getting Ready to Retrieve Geolocation Information

To configure your unit and smart device to share geolocation information:

- 1.** On your unit, if it is not done already, activate the SMARTGPS software option. For more information, see *Activating Software Options* on page 74.
- 2.** On your smart device, create a mobile wireless hotspot that will serve as a Wi-Fi network to which your unit will connect. For more information about the creation of mobile hotspots, refer to the user documentation that came with your smart device.
- 3.** If it is not done already, install EXFO Link:
 - 3a.** Ensure you have access to an Internet connection.
 - 3b.** Ensure that you have a Google account to be able to download EXFO Link.
 - 3c.** Tap the **Google Play Store** icon.
 - 3d.** In the **Google Play Store** (or **Play Store**) application, search for EXFO or EXFO Link.
 - 3e.** Follow the instructions on-screen.
- 4.** Start the EXFO Link application.

5. If it is not done already, enable the geolocation feature:

5a. From the main window, tap .

Note: Depending on the smart device you are using, the application settings could be found in the menu button instead.

5b. Select **Settings**.

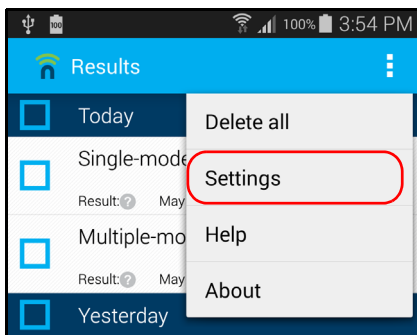

Setting Up Your Unit

Getting Ready to Retrieve Geolocation Information

5c. Under **GENERAL SETTINGS**, select the **Geolocation** option.

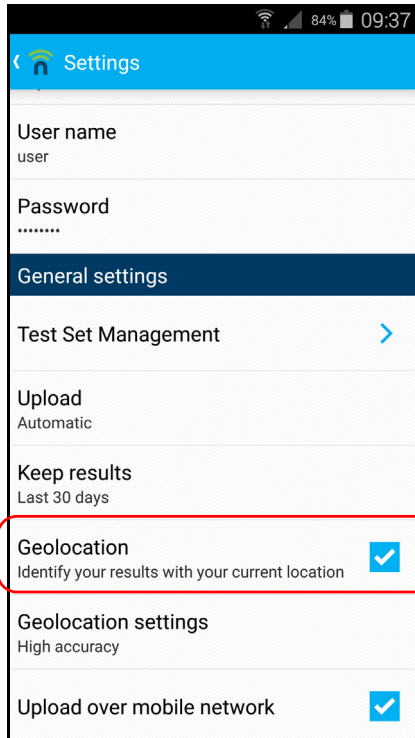

Note: For more information on how to modify other settings related to geolocation, refer to the EXFO Link user documentation.

5d. Tap  to return to the main window.

You are now ready to connect your unit to the mobile hotspot to start receiving geolocation information.

To connect your unit to the mobile hotspot:

1. On your smart device, ensure that EXFO Link is running, configured properly, and that the mobile hotspot that you have created is available.
2. Connect your unit to the mobile hotspot as you would do with any other wireless network. For more information, see *Connecting to a Wireless Network* on page 178.

Your unit is now ready to start receiving geolocation information when available.

Note: *To avoid extra fees, you may want to turn off the mobile hotspot on your smart device when you do not use it.*

Setting Up Your Unit

Configuring Parameters via Windows Mobility Center

Configuring Parameters via Windows Mobility Center

For a quick access to various parameters such as the brightness, volume, or power plans, you may want to use the Windows Mobility Center.

To configure the parameters via Windows Mobility Center:

1. From the main window, tap the **System Settings** button.
2. Tap **Windows Mobility Center**.

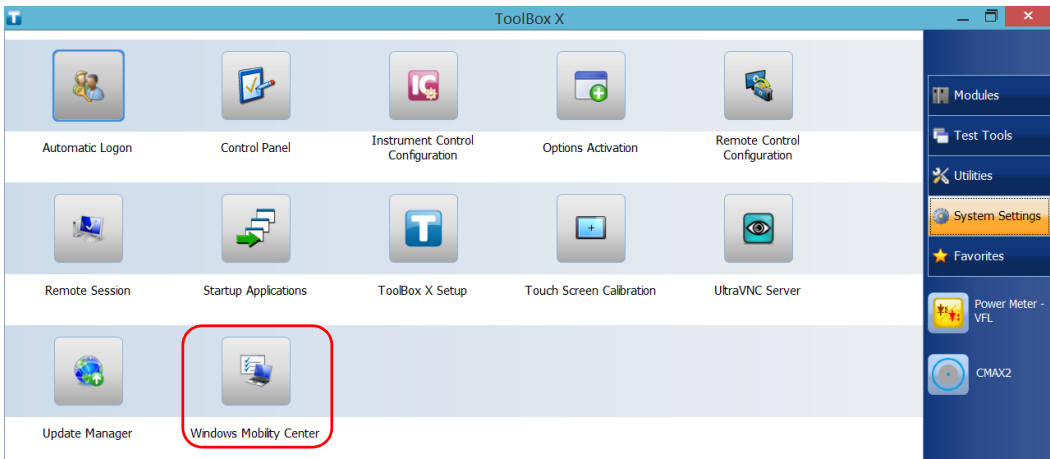

3. Set the parameters as desired.

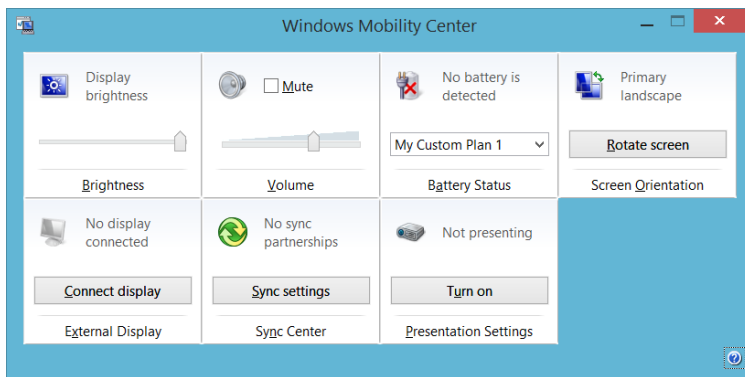

Setting Other Parameters

You can also configure many other parameters via the **Control Panel** window. Refer to Microsoft Windows documentation for details.

5 Working with Your Unit

Printing Documents

You can print documents and images directly from your unit by using either the provided PDF creation tool or an external printer (for printing on paper).

You can view the PDF files from your unit, using the provided PDF reader. For more information, see *Viewing PDF Files* on page 146.

You can use a local or a network printer to print on paper.

- Local printer: You must connect the printer to your unit and install the required software and drivers provided by the manufacturer of the printer.
- Network printer: Your unit must be accessible from this network by Wi-Fi or standard Ethernet. You must also define the printer on your unit before attempting to access it (see *Configuring Network Printers* on page 104).

Note: *Some applications may not offer print functions.*

To print documents:

1. Open the document that you want to print.
2. From the application in which you have opened your file, access the print function.

Note: *In most applications, you can access the print function by the **File** menu or by a **Print** button.*

3. Select the desired printer (PDF creation tool by default).
4. If necessary, adjust the printer's parameters to your needs.
5. Tap **Print** to start the printing process, and follow the on-screen instructions.

Working with Your Unit

Viewing PDF Files

Viewing PDF Files

You can view PDF files directly from your unit using the provided PDF file viewer. For more information on the available features for this viewer, refer to the PDF viewer online help.

Note: *You may need a connection to the Internet to access the PDF viewer online help.*

To view PDF files:

1. From the main window, tap the **Utilities** button.
2. Tap **File Manager**.

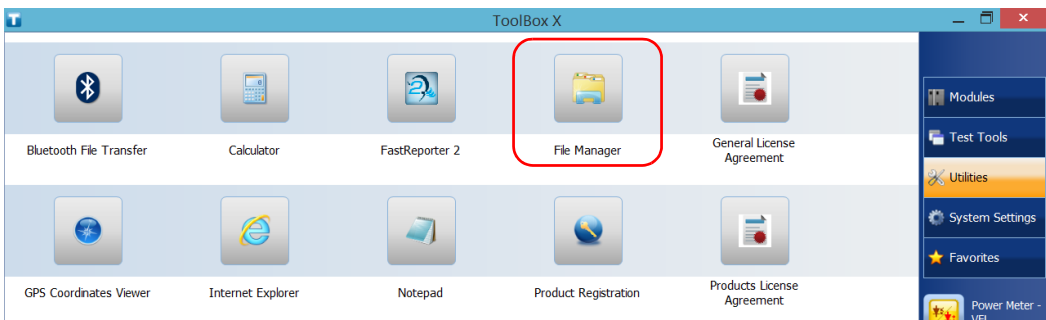

3. Browse through the folders to find the desired PDF file.
4. Double-tap the file.
5. The file opens automatically in the PDF viewer.

Taking Screen Captures

You can take captures of what is displayed on your screen, directly from your unit. This could be useful for troubleshooting when you need another person to have a look at a specific configuration or problem. You could also use this tool for training purposes.

If you want to capture images of the fibers that you examine with the fiber inspection probe, you can use the capture feature of the probe instead.

- The images are saved in .png format. They are sent to the following folder (in the account of the user currently logged on the unit):

This PC\Pictures\Screenshots

- The application generates file names as follows:

Screenshot (<Sequential_number>).png

where

Sequential_number corresponds to the number that is added each time you take a screen capture.

Note: *The name of the folders and of the files described above will vary according to the language that is currently selected in Windows.*

To take a screen capture:

From the unit's front panel, press the  button and hold it down for a few seconds.

The screen capture is automatically taken (a visual effect typical of a camera taking a picture indicates that the capture is complete).

Note: *If a keyboard is connected to your unit, you can also press the Windows logo key + PRINT SCREEN.*

Browsing the Web

You can browse the Web directly from your unit, provided that you have access to an Internet connection.

If you need to modify the Internet options, see *Configuring the Internet Options* on page 134. For more information on how to connect to the Internet using a mobile broadband USB modem key, see *Accessing the Internet with a Mobile Broadband USB Modem Key* on page 149.

To browse the Web:

1. Open a Web browser as follows:
 - 1a. From the main window, tap the **Utilities** button.
 - 1b. Tap the **Edge** (Windows 10) or the **Internet Explorer** (Windows Embedded 8 Standard and Windows 8.1 Pro) icon to open the browser.
2. Enter the desired Web address in the address bar and tap the  button (located at the right of the address bar) to start browsing.

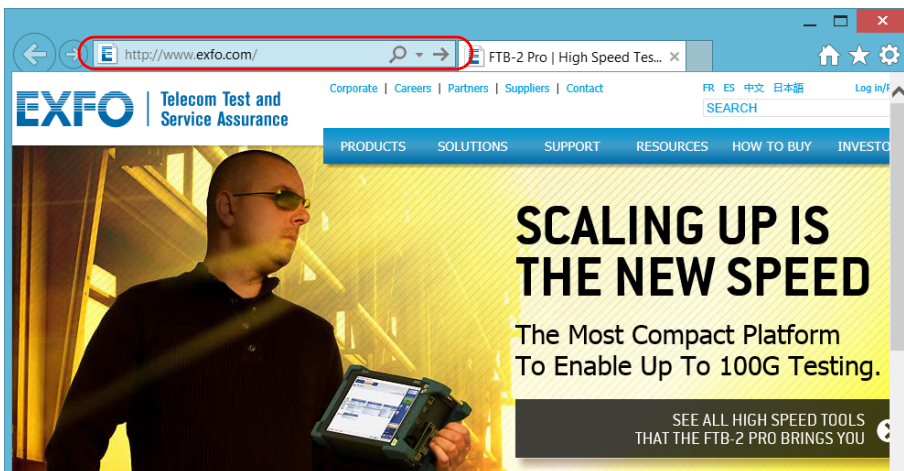

3. Close the window to return to the **Utilities** window.

Accessing the Internet with a Mobile Broadband USB Modem Key

Note: *Only administrator-level users can install software. However, when the installation is complete, all users will have the possibility to access the Internet with a USB modem key.*

You can connect a mobile broadband USB modem key to your unit to have a wireless access to the Internet.

You need to use a mobile broadband modem key equipped with an unlocked and activated Subscriber Identity Module (SIM) card (you must subscribe to a package of mobile services). If you need more information on the mobile broadband coverage in your area, contact your provider of mobile services.

Usually, you have to install an application with which you will establish a connection with the mobile network whenever you want to work with your USB modem key. Most of the time, this application is installed automatically the very first time you connect a USB modem key to your unit. In all cases, you only need to install this application once.

Working with Your Unit

Accessing the Internet with a Mobile Broadband USB Modem Key

To work with a mobile broadband USB modem key:

- 1.** If necessary, turn on your unit and wait for the startup sequence to complete.
- 2.** If necessary, connect the USB modem key to one of the USB ports of your unit.
- 3.** Start the application allowing you to establish a connection to the mobile network.
- 4.** Once the application starts, connect to the mobile network.

As soon as the connection is established, you are ready to browse the Web.

Note: *Depending on the package that you have purchased with your service provider and the type of network, you may have to set specific parameters. If you are not sure on how to proceed or need more information about the configuration, contact your service provider.*

- 5.** When you have finished working, disconnect from the mobile network, and then remove the USB modem key from your unit.

Retrieving the GPS Location of Your Unit

With your unit, a smart device, and the provided GPS utility, you can retrieve the latitude and longitude coordinates of your unit as well as the date and time of the reading. You will see either the last known coordinates or the current ones, depending on if the geolocation information could be retrieved or not.

In addition to viewing the GPS information on-screen, you can copy it to the Clipboard in two formats: a text string or a URL link. The text string contains the GPS coordinates as well as a date and time stamp. Once the information is in the Clipboard, you can paste it to any document or test report (in editable sections). If your unit is connected to the Internet, you can even directly paste the URL link to a Web browser to locate your unit on a map.

For information on how to configure your unit and smartphone to retrieve geolocation information, see *Getting Ready to Retrieve Geolocation Information* on page 137.

To retrieve the GPS location of your unit:

- 1.** If necessary, turn on your unit and wait for the startup sequence to complete.
- 2.** On your smart device, ensure that EXFO Link is running and that the mobile hotspot that you have created is available.
- 3.** Connect your unit to the mobile hotspot as you would do with any other wireless network. For more information, see *Connecting to a Wireless Network* on page 178.

Working with Your Unit

Retrieving the GPS Location of Your Unit

4. From the main window, tap the **Utilities** button, then tap **GPS Coordinates Viewer**.



The GPS coordinates are displayed.

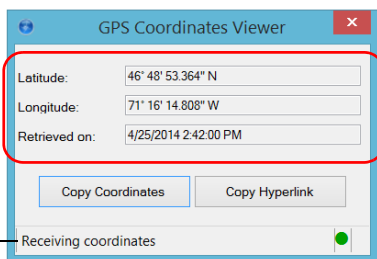

Status of the connection

Note: *If you see “GPS not detected” at the bottom of the **GPS Coordinates** window, this could mean that either the SMARTGPS option is not activated on your unit, or there is a problem with the link to the mobile hotspot. When geolocation information is available, the utility will display “Receiving coordinates”.*

Note: *If you have problems receiving coordinates, you may want to try using the unit and smart device outdoors, and as far away as possible from buildings and other solid objects.*

- Tap **Copy Coordinates** to send the displayed information to the Clipboard as a text string.
- Tap **Copy Hyperlink** to send the displayed information to the Clipboard as a URL link.

5. When your work is finished, tap  to close the utility.

Managing Favorites

For a quicker access to the applications that you use most often, you may want to build your own list of favorite applications (Favorites).

You can add and remove Favorites from the list. You can also import and export lists of Favorites, which could be useful for backup and recovery purposes, or to share the same Favorites among several units.

Note: *To have access to the same Favorites on several units, the corresponding applications must be available on all units.*

To add Favorites:

1. From the main window, tap the **Favorites** button.
2. Tap **Favorites Management**.

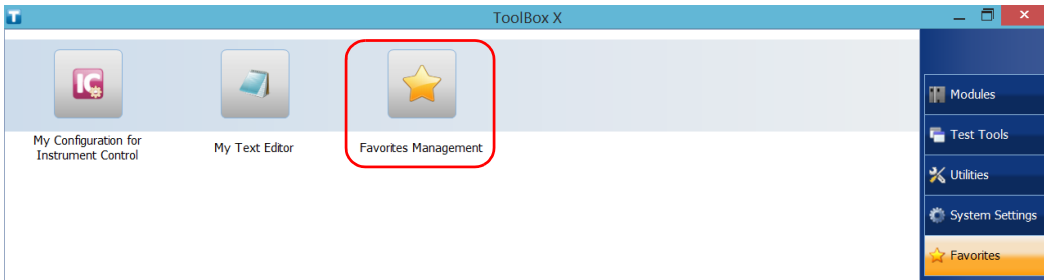

3. Tap **Add**.

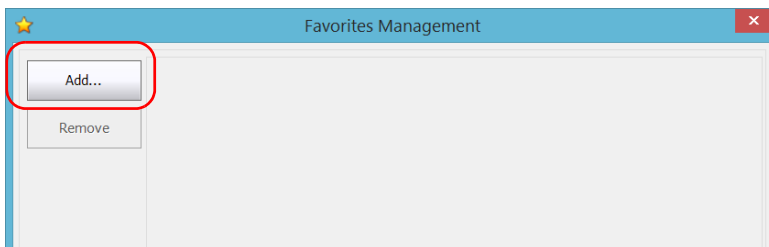

4. Tap **Browse** to locate the desired application.

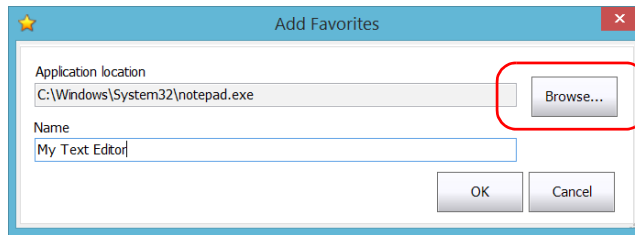

5. Type a name for the new Favorite.
6. Tap **OK** to confirm the location and name.
7. Repeat the previous steps with all the Favorites that you want to add.
8. Tap **OK** to apply the changes and close the window.

To remove Favorites:

1. From the main window, tap the **Favorites** button.
2. Tap **Favorites Management**.

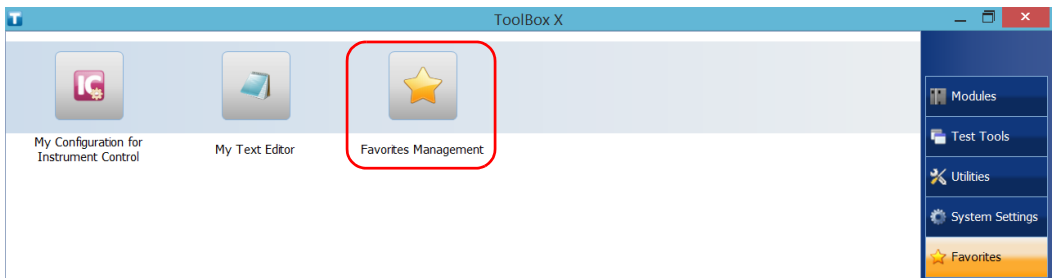

Working with Your Unit

Managing Favorites

3. Tap the icon corresponding to the Favorite that you want to remove from the list.

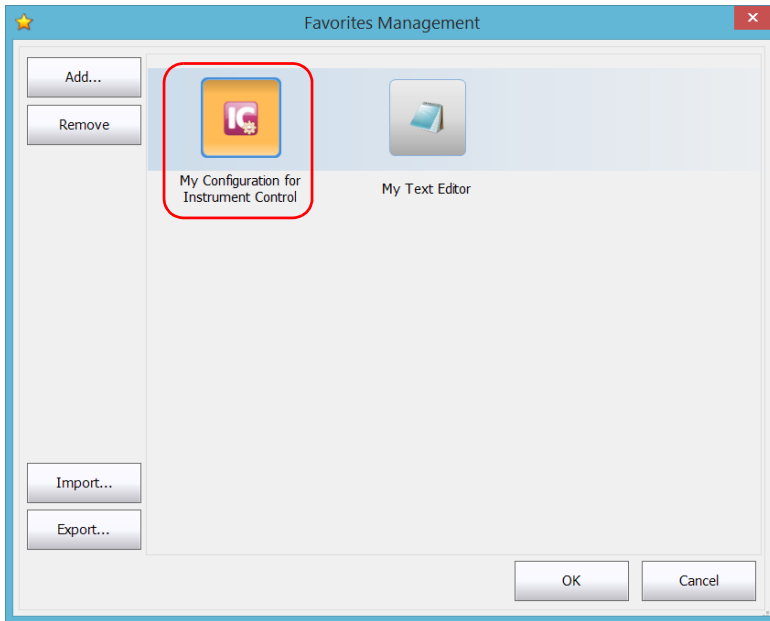

4. Tap **Remove**.

Note: *The application will not prompt you to confirm the removal of the Favorite from the list. Removing a Favorite from the list does not uninstall the application from the unit.*

5. Tap **OK** to apply the changes and close the window.

To work with Favorites:

- 1.** From the main window, tap the **Favorites** button.
- 2.** Tap the icon corresponding to the application that you want to use.

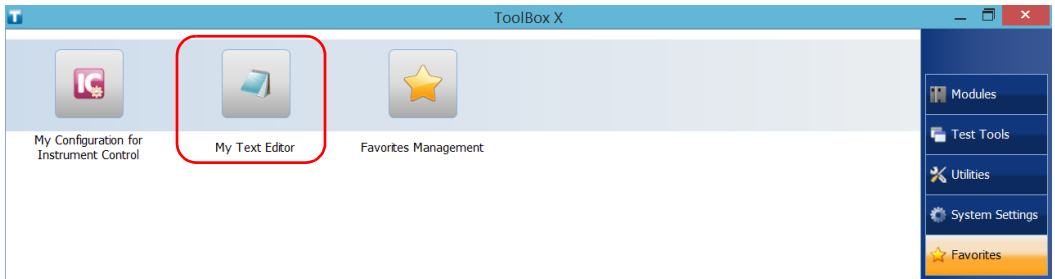

Working with Your Unit

Managing Favorites

To export the list of Favorites:

1. From the main window, tap the **Favorites** button.
2. Tap **Favorites Management**.

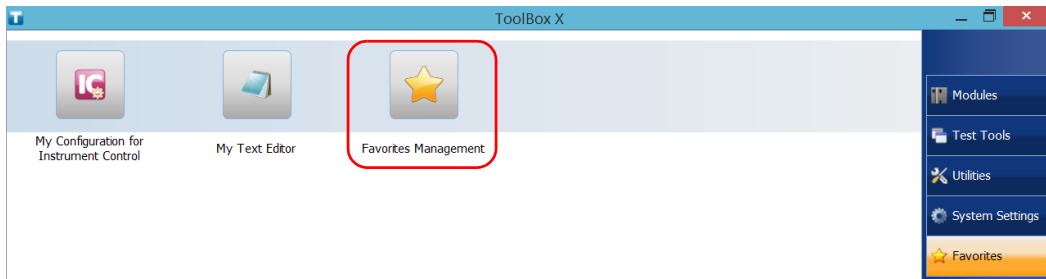

3. Tap **Export**.

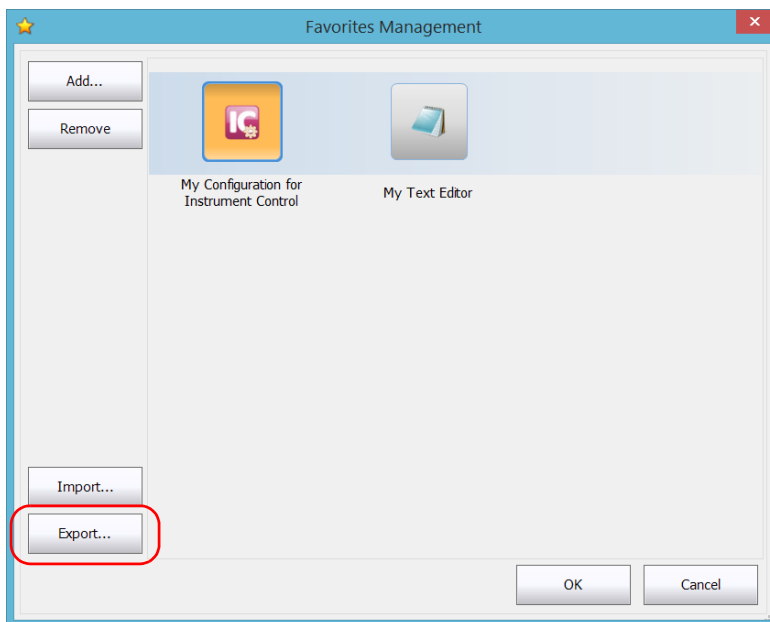

4. Select a location and type a name for the Favorites list.

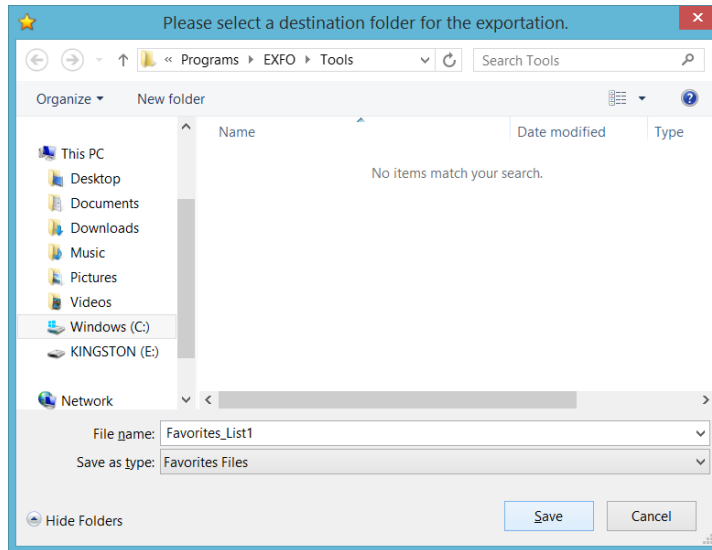

5. Tap **Save**.
6. Tap **OK** to apply the changes and close the window.

Working with Your Unit

Managing Favorites

To import a list of Favorites:

1. From the main window, tap the **Favorites** button.
2. Tap **Favorites Management**.

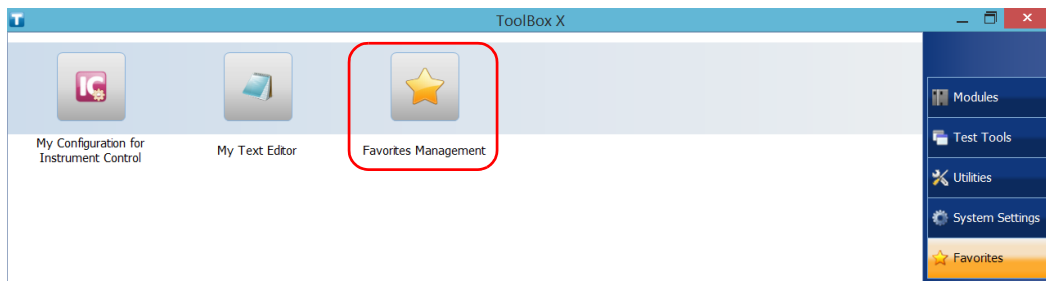

3. Tap **Import**.

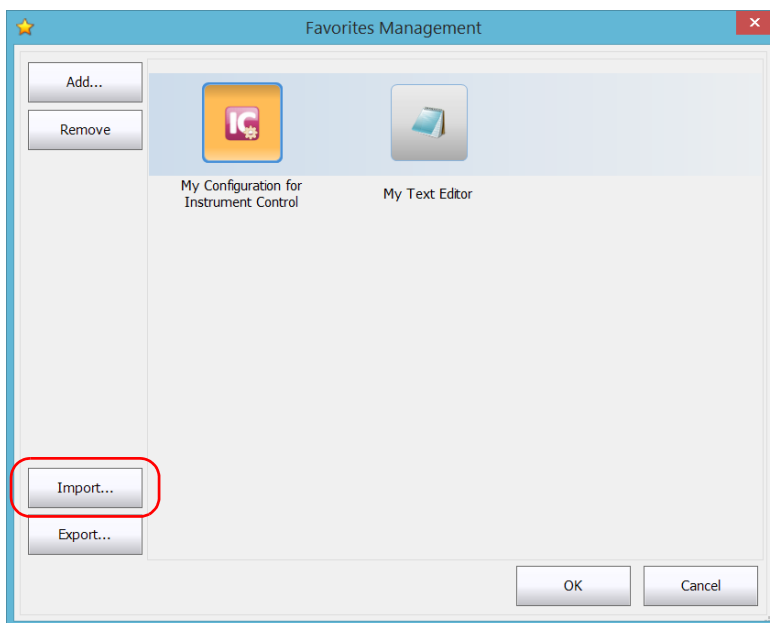

4. Select the desired Favorites list.

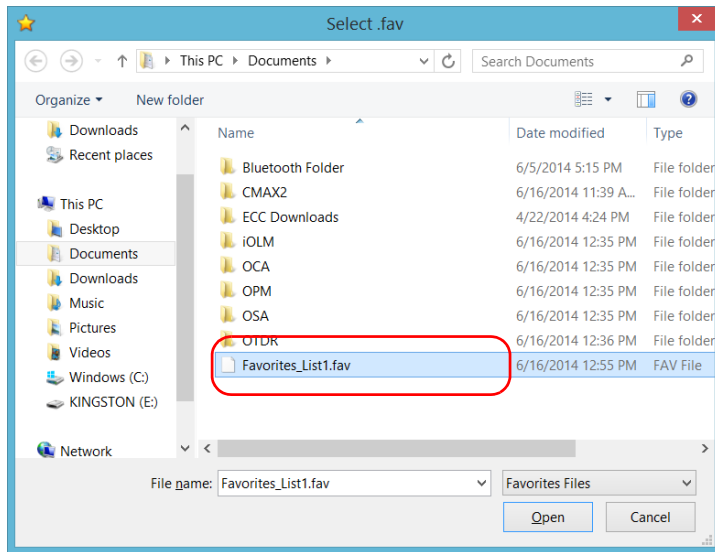

5. Tap **Open**.
6. Tap **OK** to apply the changes and close the window.

Using the Calculator

You can use Microsoft Calculator directly from your unit.

To use the Calculator:

1. From the main window, tap the **Utilities** button.
2. Tap **Calculator**.

Using the Text Editor

You can use Microsoft Notepad directly from your unit.

To use the text editor:

1. From the main window, tap the **Utilities** button.
2. Tap **Notepad**.

Accessing Other Tools

Your unit comes with various tools that can help you better analyze or manage your data.

You have also access to free tools such as Wireshark to help you troubleshoot networks. For more information, refer to the online help provided with these tools, when applicable.

To access the applications:

1. From the main window, tap the **Test Tools** button.

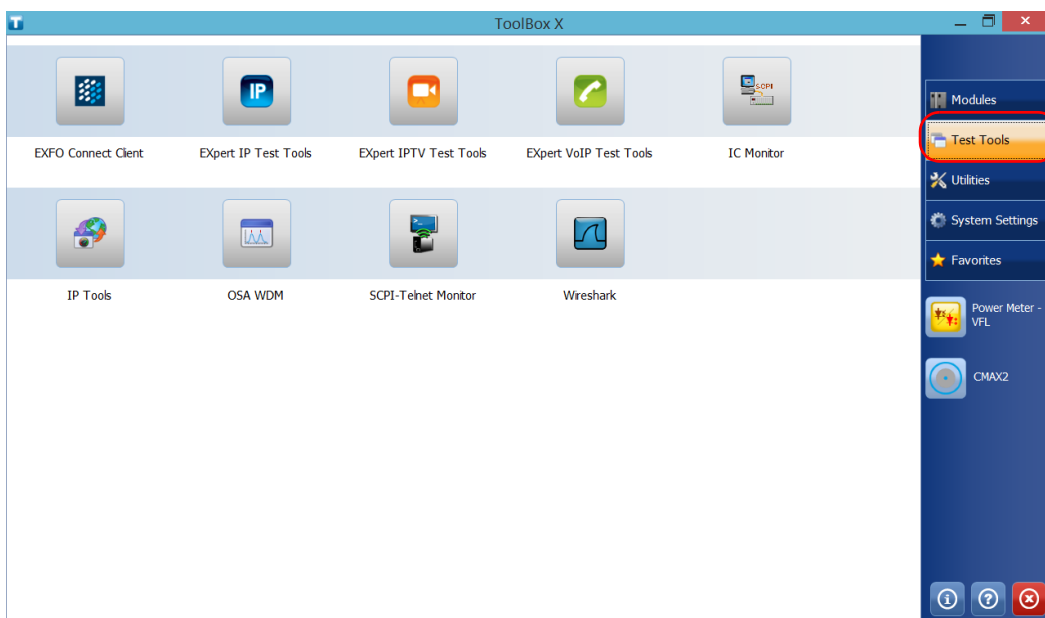

2. Tap the icon corresponding to the application that you want to start.

6 *Using the Optional Built-In Power Meter and VFL*

Your unit can be equipped with an optical power meter and a visual fault locator (VFL).

With the power meter, you can measure absolute power (dBm or W) or insertion loss (dB). The power meter can detect modulated signals (1 kHz, 2 kHz, and 270 Hz). With the VFL, you can inspect or identify fibers. For more information on how to use the power meter or the VFL, refer to the power meter online help.



IMPORTANT

If you intend to take measurements with a very low power level, make sure that your testing conditions are optimal to ensure the best results (for example, do not use the VFL, make sure that the other modules in your platform are not performing measurements and that their internal parts are not moving, etc.).

Using the Optional Built-In Power Meter and VFL

To access the built-in power meter or the VFL:

From the main window, tap **Power Meter and VFL**.

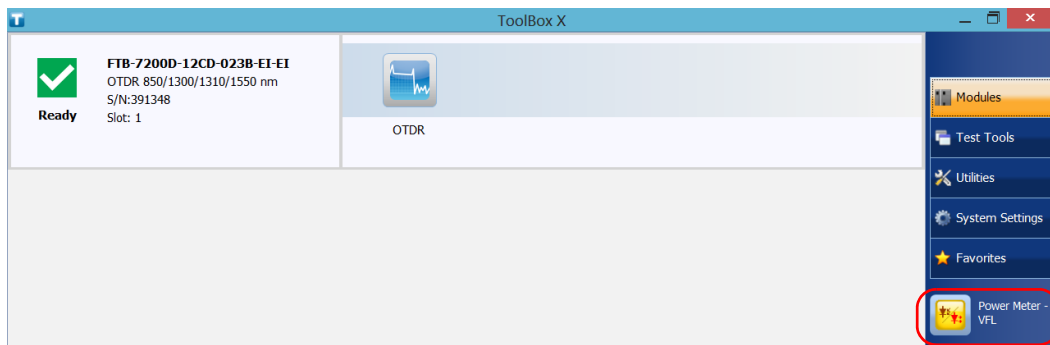

Note: The **Power Meter and VFL** button is only visible if your unit is equipped with a power meter and a VFL.

Note: You can access the online help of the power meter and the VFL by tapping the  button from the power meter application.

7 *Inspecting Fibers with a Probe*

The fiber inspection probe (FIP) is used to find dirty or damaged connectors by displaying an enlarged view of the connector surface. You can connect an FIP to your unit to view fiber ends.



IMPORTANT

Only the probes of the FIP-400B series are supported on your unit.

Fiber inspections are made using the ConnectorMax2 application. For more information, refer to the ConnectorMax2 online help.

To inspect fibers with a probe:

1. Connect the probe to one of the USB ports of your unit (right or top panel).
2. From ToolBox X, tap the **ConnectorMax2** button to open the application.

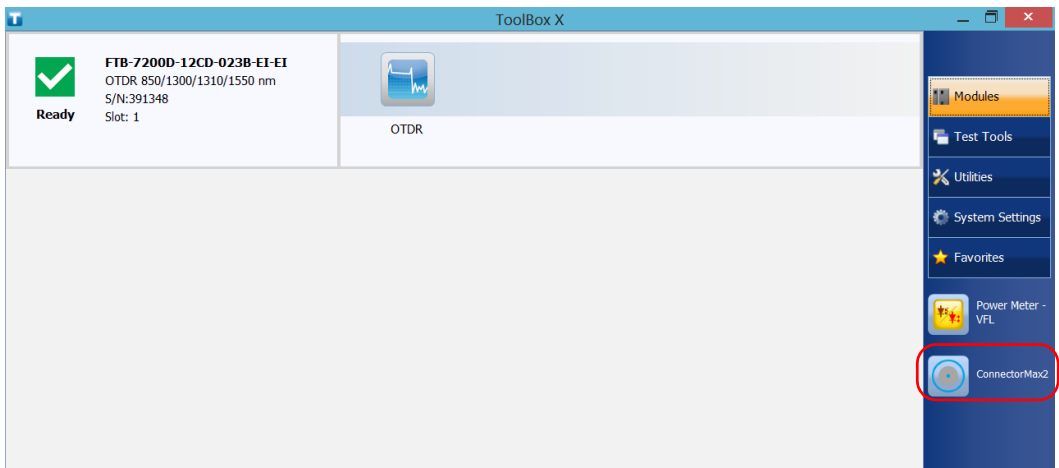

Note: You can access the online help by tapping the  button from the ConnectorMax2 application.

8 ***Managing Data***

You can copy, move, rename, delete files and folders directly on your unit.

You can transfer files from your unit to a USB memory key or a computer. You can also transfer data from a storage device or a computer to your unit.

Your unit is equipped with the following ports and devices for data transfer:

- Two USB 2.0 ports and one USB 3.0 port to connect a memory key
- an Ethernet port to connect to a network (for transfer via VNC or Remote Desktop - see *Accessing Your Unit Remotely* on page 203)
- internal Wi-Fi and Bluetooth® module (optional) to connect to a wireless network or transfer data via the Bluetooth® technology

Managing Data

Viewing Disk Space and Managing Files

Viewing Disk Space and Managing Files

To help you manage the data that is stored on your unit, you can easily view the remaining disk space. You can also copy, move, rename, delete files and folders directly from your unit.

To view the free disk space, and manage files and folders:

1. From the main window, tap the **Utilities** button.
2. Tap **File Manager**.

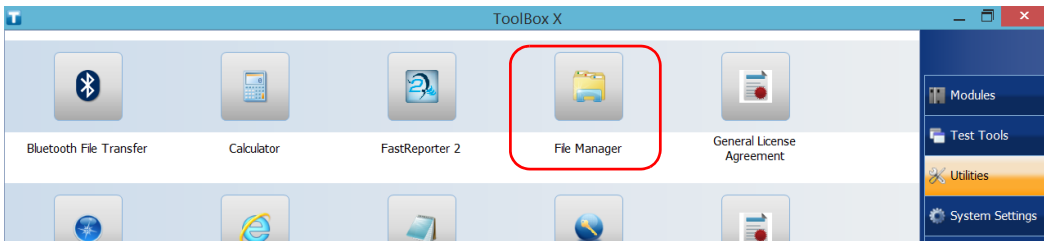

The file explorer is displayed.

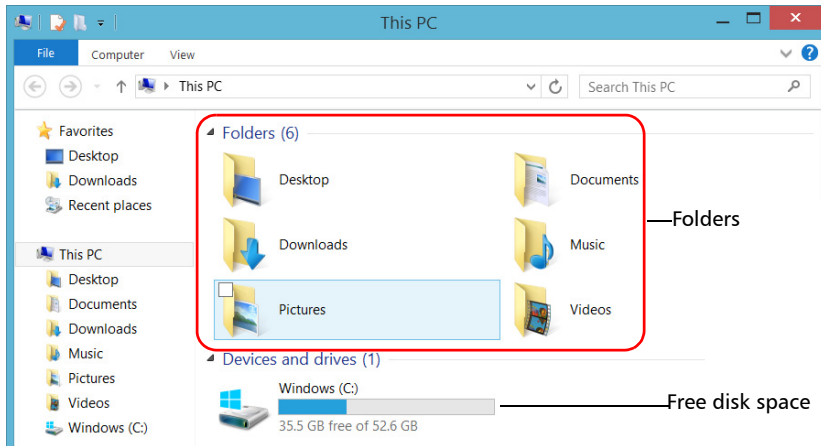

Note: The free disk space is also visible from the **Platform** tab (tap  in the lower right corner of the main window).

Transferring Data Using the Bluetooth Technology

If you have purchased the RF (Wi-Fi and Bluetooth®) option, you can transfer data between your unit and a computer (or another device such as a smartphone) using the Bluetooth® technology. In all cases, you must ensure that the computer or the device is compatible with the Bluetooth® technology and configured properly.

Note: *Some devices that are compatible with the Bluetooth® technology only allow data transfer between devices of the same manufacturer. In this case, you will need to use another type of device or a standard computer to transfer data from your unit.*

Your unit must be located within a 10-meter area from your computer (limitation of the Bluetooth® Class 2 devices).

Since transfer speed is limited for larger files (more than 1 GB), if you need to transfer such files, you may want to use a USB key, or connect to a Wi-Fi or an Ethernet network.



IMPORTANT

Depending on the operating system that your computer is running (or on the smartphone that you are using), it is possible that only data transfer secured with a passkey be allowed.

The procedure presented hereafter explains how to transfer data from your unit to a computer.

Note: *If you transfer files from a computer to your unit, they will be sent automatically to the This PC\Documents\Bluetooth Folder on your unit.*

Managing Data

Transferring Data Using the Bluetooth Technology

To configure your unit and the computer for transfer:

1. Configure your unit as follows:

1a. From the notification area, tap the Bluetooth® icon.

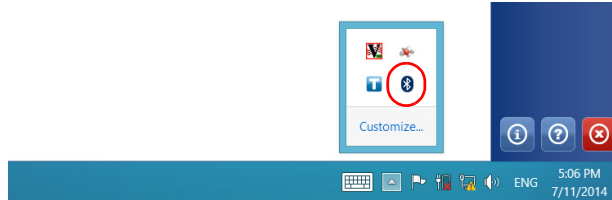

1b. Tap **Open Settings**.

1c. From the **Options** tab, under **Discovery**, select the **Allow Bluetooth devices to find this PC** check box.

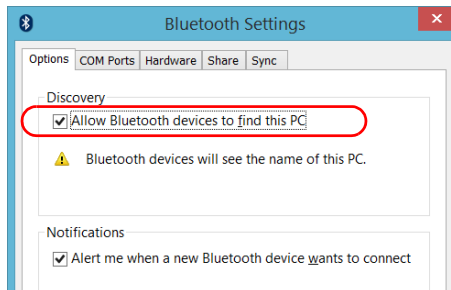

- 1d.** From the **Share** tab, ensure that the **Allow remote devices to browse, send, and receive pictures, music, and other files** check box is selected.

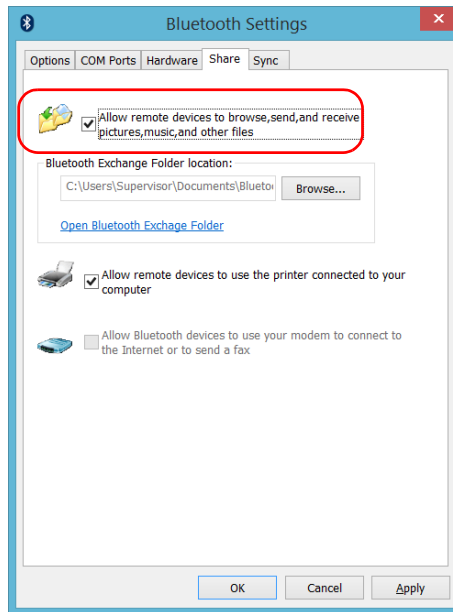

- 1e.** Tap **OK** to confirm.
- 2.** Configure the computer as follows:
 - 2a.** From the notification area, click the Bluetooth[®] icon.
 - 2b.** Select **Open Settings**.
 - 2c.** Ensure that the option allowing Bluetooth[®] devices to find the computer is selected.
 - 2d.** Click **OK** to confirm.

Managing Data

Transferring Data Using the Bluetooth Technology

To transfer data via the Bluetooth® technology:

1. Pair your computer with your unit as follows.
 - 1a. From the notification area, tap the Bluetooth® icon.

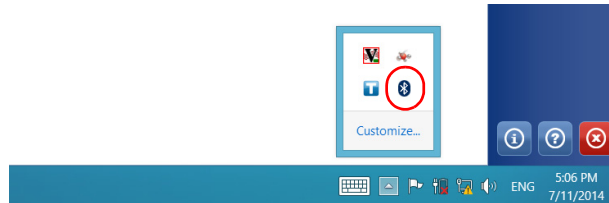

- 1b. Tap Add a Bluetooth Device.
- 1c. From the list of Bluetooth® devices, tap the item corresponding to the computer to which you want to transfer files.

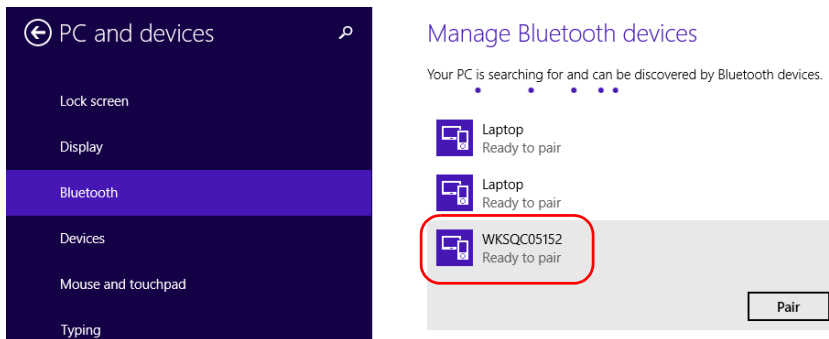

- 1d.** On the FTB-2 running Windows 10, FTB-2 Pro, or FTB-4 Pro, tap **Pair**. On the FTB-2 running Windows Embedded 8 Standard, the application tries to establish the pairing automatically.

Note: *If the computer or device that you want to select is already paired, you must remove the pairing first with the **Remove device** button. On the FTB-2 running Windows Embedded 8 Standard, you must first tap the  button to view the **Remove device** button.*

Note: *Depending on the computer that you are using, the application will either provide you with a passkey, or prompt you to confirm that the displayed passkey matches the passkey used on the computer.*

- 1e.** If necessary, write down the provided passkey.
- 1f.** On the computer, when the application prompts you, follow the on-screen instructions. Enter the passkey that you wrote down earlier, or confirm the correspondence between the two passkeys.

Managing Data

Transferring Data Using the Bluetooth Technology

2. Transfer the files as follows.
 - 2a. From the main window, tap the **Utilities** button.
 - 2b. Tap **Bluetooth File Transfer**.

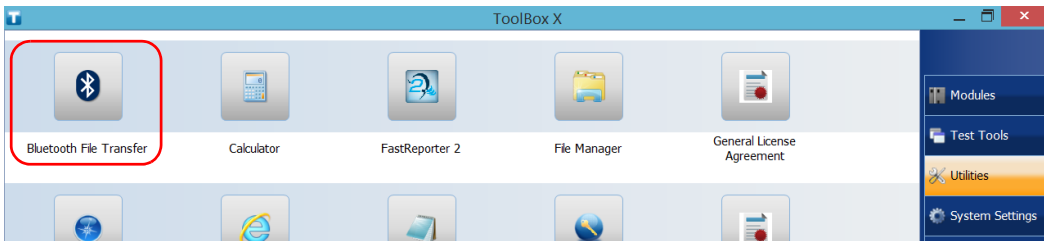

- 2c. Select **Send files**.

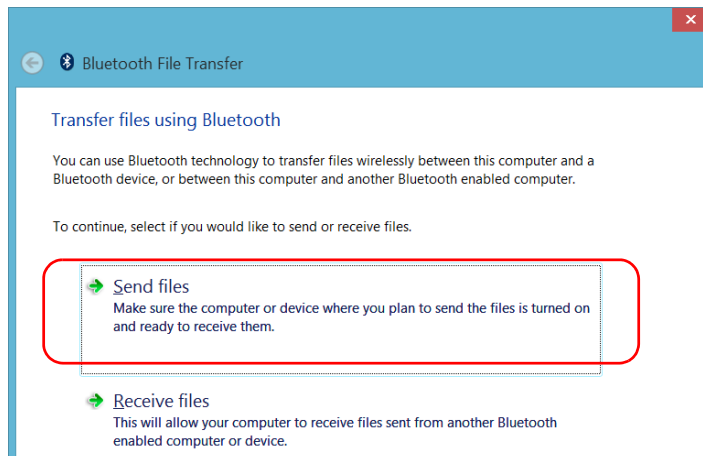

2d. Select the desired computer, and then tap **Next**.

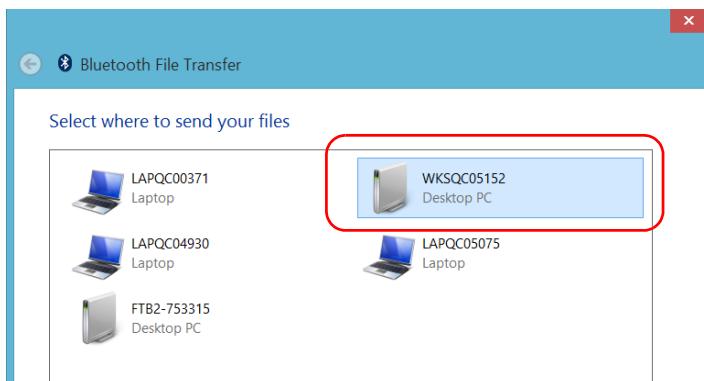

2e. Tap the **Browse** button to select the file that you want to transfer, and then tap **Next**.

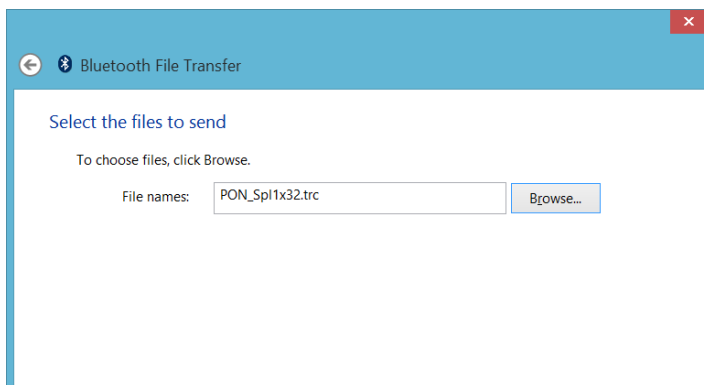

2f. Tap **Finish** when the transfer is complete.

Connecting to a Wireless Network

If you have purchased the RF (Wi-Fi and Bluetooth®) option, you can connect to a wireless network and benefit from all resources that are available on this network. You can transfer data exactly as you would do from an Ethernet network. By default, the internal wireless module is enabled, but not connected to a network.

If you have disabled the Wi-Fi device, you must enable it before trying to connect to a wireless network (see *Enabling or Disabling the Wireless Communication* on page 191).

Note: *To save power when your unit is running on batteries, you may wish to disable the Wi-Fi device when you do not use it.*

To connect to a wireless network:

1. In Windows 10, from the notification area, tap the notification preview icon.

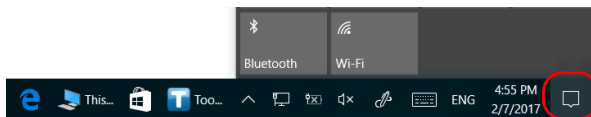

OR

In Windows 8.1 Pro or in Windows Embedded 8 Standard, from the right side of the screen, swipe left to display the Charm bar.

2. In Windows 10, tap **Network**.

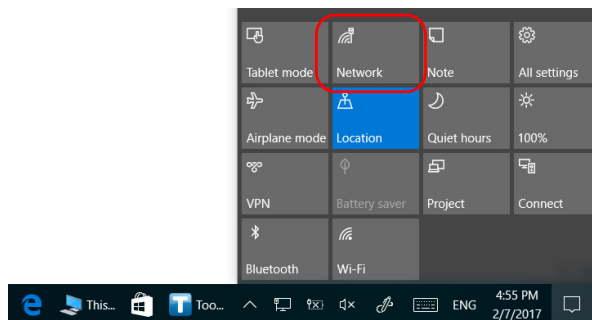

OR

In Windows 8.1 Pro or in Windows Embedded 8 Standard, tap

Settings, and then the



icon.

Managing Data

Connecting to a Wireless Network

3. Tap the item corresponding to the wireless network to which you want to connect.

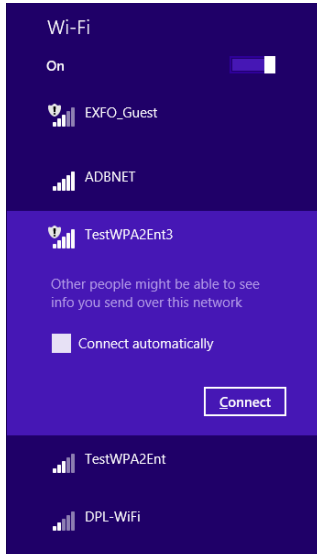

4. Tap **Connect**.
5. If the network is protected by a network security key (password) enter it in the corresponding box and tap **Next**.
6. Follow the on-screen instructions.

Note: *Since all networks are different, you may also need to configure other parameters before being able to transfer data via Wi-Fi. For information on the configuration specific to your network, contact your network administrator.*

As soon as the connection is established, you can start working with the selected wireless network. When you have finished, from the **Networks** list, tap **Disconnect** to stop communication with the wireless network.

Using the USB to RS-232 Adapter

If you want to transfer data between your unit and a device that is only equipped with RS-232 (serial) ports, you have to use a USB/RS-232 adapter (sold by EXFO).

Once the adapter has been detected, the unit assigns it a COM port number (for some adapters, values do not begin at COM 1). This COM port number is kept in memory even when you turn the unit off. This means that next time you connect the same adapter to any of the USB ports, the unit will recognize the adapter and identify it with the saved COM port number.

The communication between your unit and the device is established using the PuTTY application.

Managing Data

Using the USB to RS-232 Adapter

To use the USB/RS-232 adapter:

1. Turn on both the unit and the serial device.
2. Connect as shown. You can connect the USB end of the adapter to any of the USB ports.

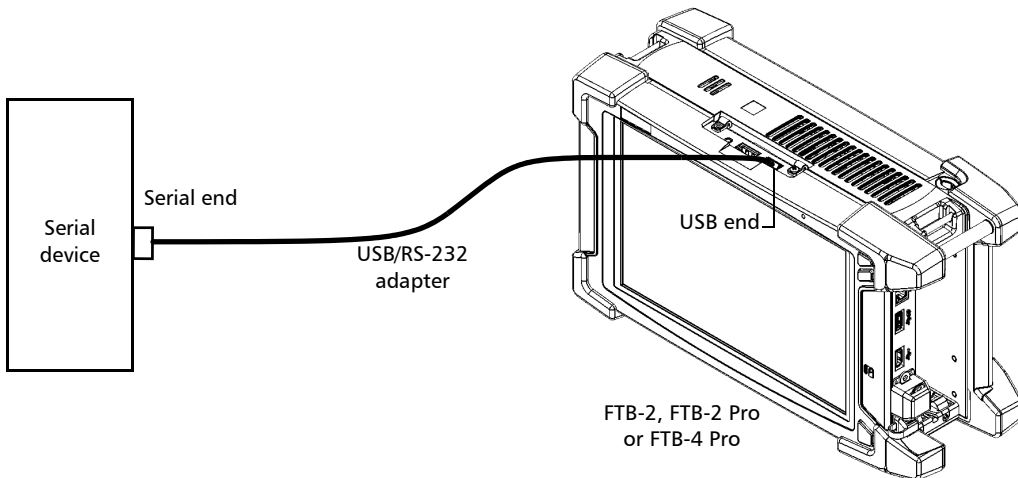

Note: *If the device that you want to use is a computer (not equipped with USB ports) you may want to use a null-modem serial cable as an “extension cable” between the device and the USB/RS-232 adapter.*

The adapter will be detected automatically on your unit.

3. From your unit, retrieve the COM port of the adapter as follows:

3a. From the main window, tap the **System Settings** button.

3b. Tap **Control Panel**.

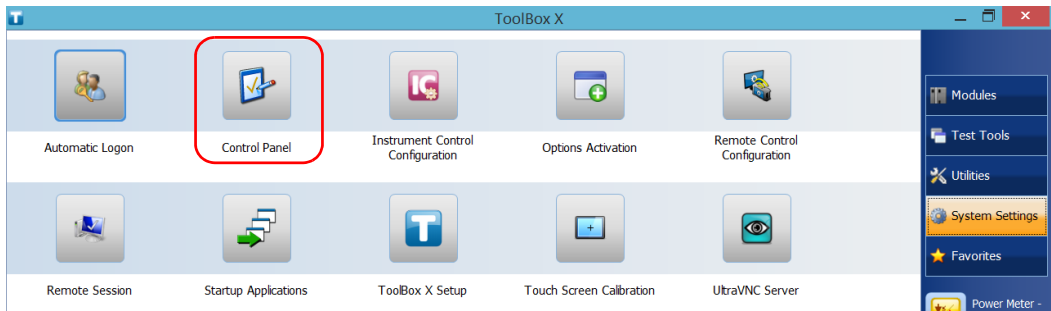

3c. Tap **Hardware and Sound**.

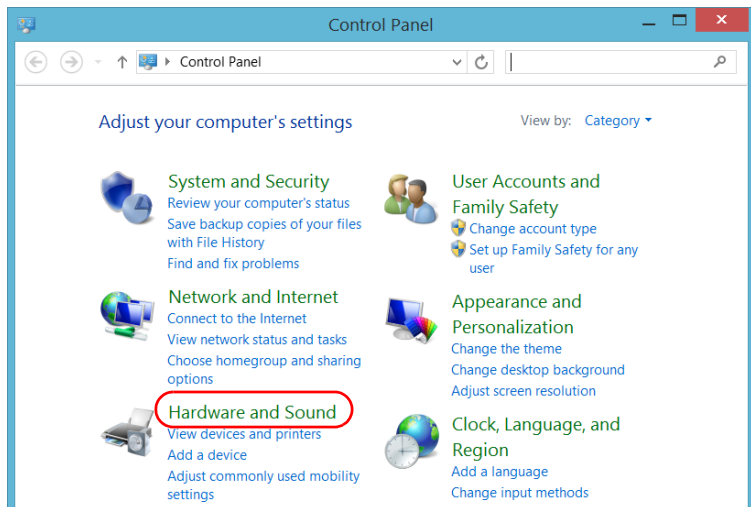

Managing Data

Using the *USB to RS-232 Adapter*

3d. Under **Devices and Printers**, tap **Device Manager**.

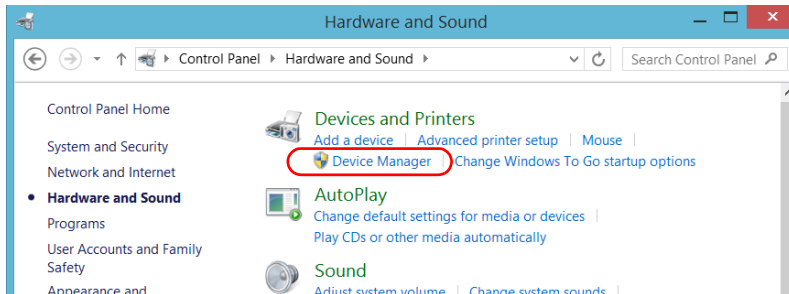

3e. Expand the **Ports (COM & LPT)** list to retrieve the COM port number that has been assigned to the adapter (identified as *USB Serial Port*) and write it down.

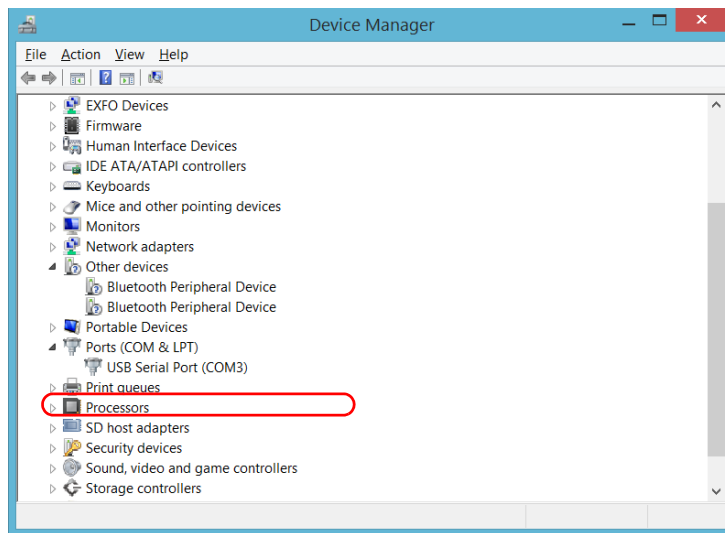

3f. Close the *Device Manager*.

4. From your unit, configure the communication parameters as follows:
 - 4a. From the main window, tap the **Utilities** button.
 - 4b. Tap **PuTTY**.
 - 4c. Configure the parameters.

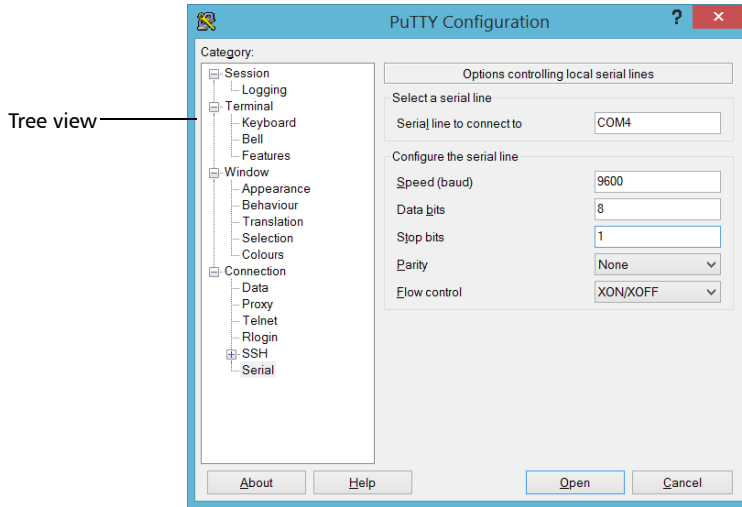

- From the tree view, select **Connection** > **Serial** and set the parameters as needed. Ensure that the COM port that you specify corresponds to the one that you wrote down at step 3e.
 - If you want to view the characters that you type on screen, from the tree view, select **Terminal**. Under **Local echo**, set the value to **Force on**.
 - From the tree view, select **Session**. Select **Serial**. The COM port number and the speed should correspond to those that you have previously entered.
- 4d. Tap **Open**. The unit is now ready to receive or send data.

Managing Data

Using the USB to RS-232 Adapter

5. From the device, set the communications parameters.



IMPORTANT

To be able to establish a communication between the unit and the device, you must set the following parameters to the same values as those defined on your unit:

- Speed
- Data bits
- Stop bit
- Parity
- Flow control

Note: *The COM port number that you set on your device will probably differ from the one that you used on your unit.*

6. From the device, establish communication with the unit using your favorite communication tool (PuTTY, HyperTerminal, etc.).

Freeing Up Disk Space with the Disk Cleanup Utility

If you need to free up disk space on your unit, you can use the Windows Disk Cleanup utility.

With this utility, you can clear files such as the Internet temporary files, files from the Recycle bin, or even files that you no longer need from the previous installation. The files from the previous installation are stored in the *Windows.old* folder that Windows creates automatically when you perform a refresh operation. To avoid losing data, you may want to back up files from this folder before removing it.

To free up disk space with the Disk Cleanup utility:

1. If desired, back up your data.

Note: *If you want to have a look at the content of the Windows.old folder containing files of the previous installation, go to the root of the C drive (Windows (C:)). If you do not see the Windows.old folder, it means no refresh operation has ever been performed on your unit.*

2. From the main window, tap the **System Settings** button.

Managing Data

Freeing Up Disk Space with the Disk Cleanup Utility

3. Tap Control Panel.

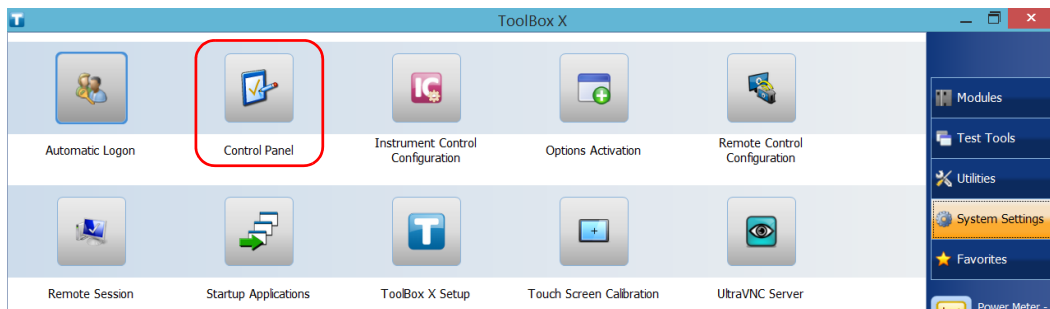

4. Tap System and Security.

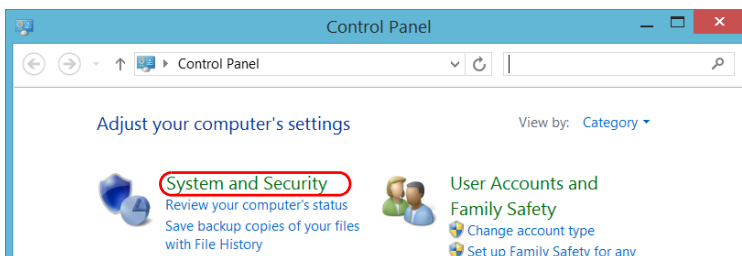

5. Tap **Administrative Tools**, and then double-tap **Disk Cleanup**.

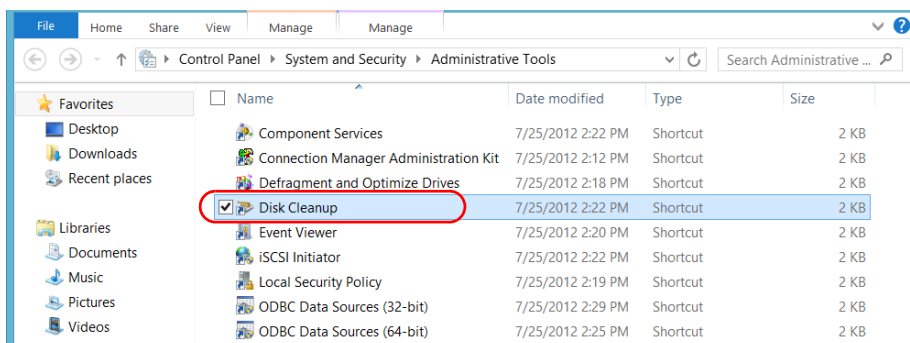

6. If you want to free up even more disk space by removing system files such as the files from the Windows.old folder, tap **Clean up system files**.

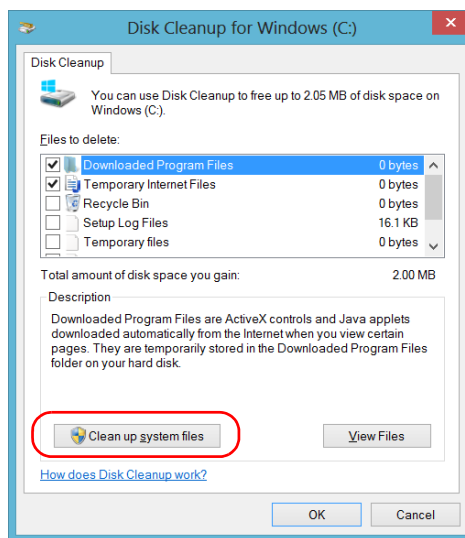

Managing Data

Freeing Up Disk Space with the Disk Cleanup Utility

- When the folders are displayed, select the check box corresponding to the desired item. If you want to clear the Windows.old folder, select the **Previous Windows installation(s)** check box. Ensure that all the other check boxes are cleared.

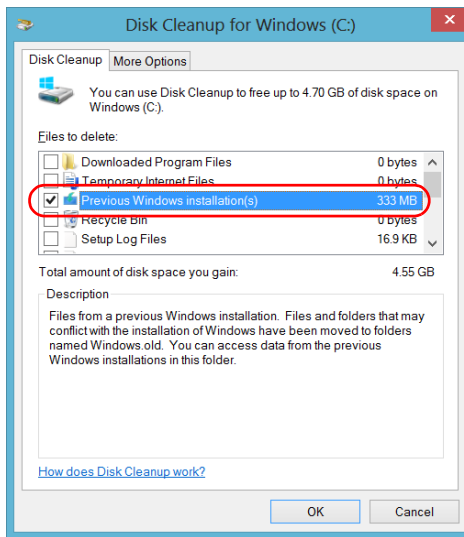

Note: If you cannot see the **Previous Windows installation(s)** check box, this means that no refresh operation has been made on your unit yet.

- Tap **OK**.
- When the application prompts you to confirm the deletion of the folder, tap **Delete Files**.

Enabling or Disabling the Wireless Communication

By default, the internal wireless module is enabled on your unit if you have purchased the RF (Wi-Fi and Bluetooth®) option.

However, if you do not intend to work with a wireless network or to transfer data with the Bluetooth® technology for a certain period of time, you may wish to disable the wireless communication to extend battery life. If you prefer, you can disable the Wi-Fi and Bluetooth® communication as well as the mobile broadband USB modem key at the same time by activating the “airplane mode”.



IMPORTANT

On units running Windows 8.1 Pro or Windows Embedded 8 Standard, you cannot disable the Bluetooth® communication either manually or with the airplane mode.

When you activate the airplane mode, only the Wi-Fi communication and the mobile broadband USB modem key (connected to your unit) are disabled.

You can enable the Wi-Fi and Bluetooth® communication as well as the mobile broadband USB modem key again at any time.

Managing Data

Enabling or Disabling the Wireless Communication

To enable or disable the wireless communication in Windows 10:

1. From the notification area, tap the notification preview icon.

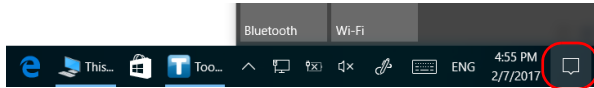

2. Set the wireless communication parameters as needed.
 - If you want to set the parameters for the Wi-Fi and the Bluetooth[®] communication, as well as the mobile broadband USB key at the same time, tap the **Airplane mode** button to turn this mode on or off. Turning this mode on disables the communication, and turning it off enables the communication.

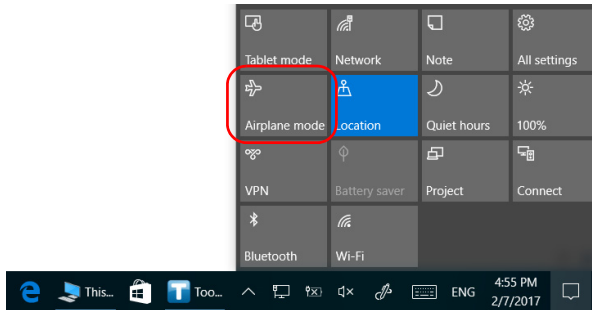

- If you want to set the parameters for the Wi-Fi or the Bluetooth[®] communication only, tap the desired button to turn the corresponding communication on or off.

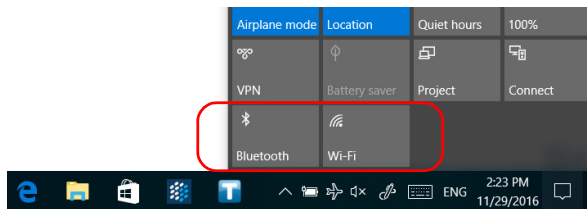

To enable or disable the wireless communication in Windows 8.1 Pro:

1. From the right side of the screen, swipe left to display the Charm bar.
2. Tap **Settings**, and then the  icon.
The icon is a blue square with a white signal strength indicator and the word "Available" below it.
3. Set the wireless communication parameters as needed.
 - If you want to set the parameters for the Wi-Fi device and the mobile broadband USB key at the same time, set the **Airplane mode** slider to the **Off** position to enable the communication, or to the **On** position to disable it.

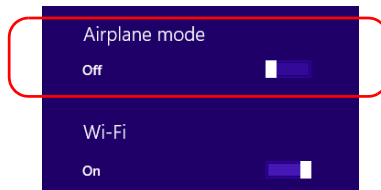

- On an FTB-2 Pro, if you want to set the parameters for the Wi-Fi device only, set the **Wi-Fi** slider to the **On** position to enable the communication, or to the **Off** position to disable it.

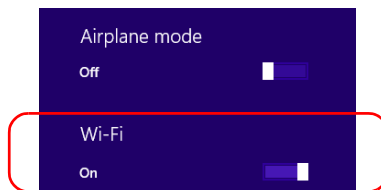

Managing Data

Enabling or Disabling the Wireless Communication

To enable or disable the wireless communication in Windows Embedded 8 Standard:

- 1.** From the right side of the screen, swipe left to display the Charm bar.
- 2.** Tap **Settings**, and then **Change PC Settings**.
- 3.** Tap **Wireless**.

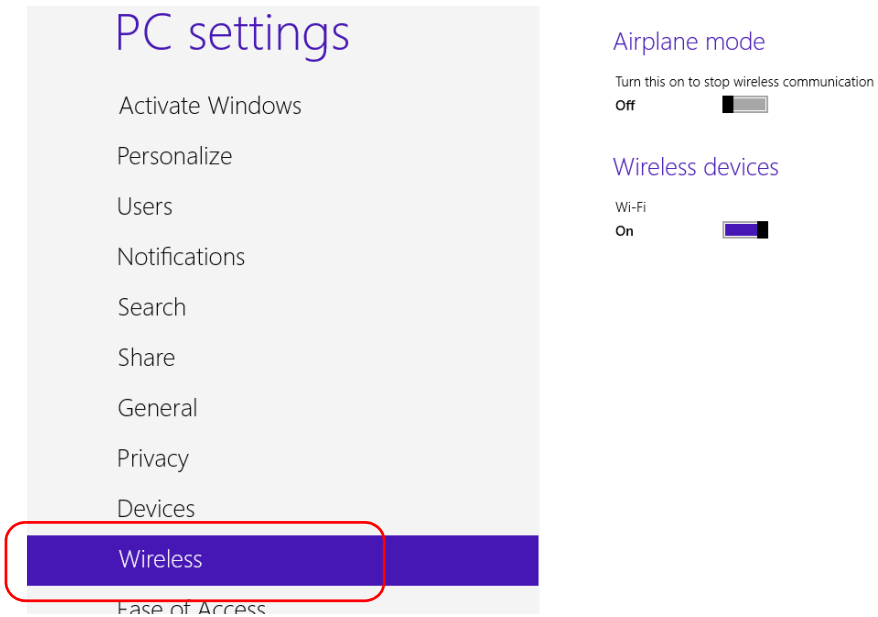

4. Set the wireless communication parameters as needed.
 - If you want to set the parameters for the Wi-Fi device and the mobile broadband USB key at the same time, set the **Airplane mode** slider to the **Off** position to enable the communication, or to the **On** position to disable it.

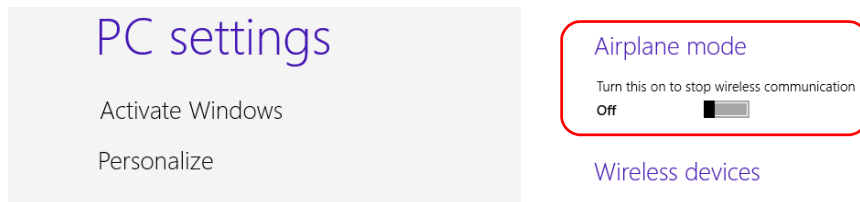

- If you want to set the parameters for the Wi-Fi device only, set the **Wi-Fi** slider to the **On** position to enable the communication, or to the **Off** position to disable it.

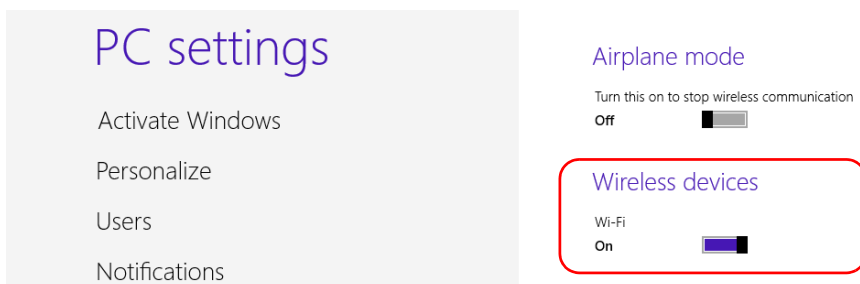

Connecting to a VPN from Your Unit

Note: *Only administrator-level users can install software under Windows. However, when the installation is complete, all users have the possibility to connect to the newly installed VPN from the unit.*

You can connect to a Virtual Private Network (VPN) from your unit if you use one of the VPN clients (applications) that are part of Windows, or provide your own compatible VPN client (Windows 10 and Windows 8.1 Pro only). Such clients allow you to connect to the VPN of your company from anywhere in the world and have access to network resources as if your unit was connected locally to the network. This could be useful if you need to transfer data to a centralized folder on the company's private network, for example.

To establish the communication between the VPN client and the VPN server, you can use either a mobile broadband USB modem key (see *Accessing the Internet with a Mobile Broadband USB Modem Key* on page 149) or a standard Ethernet connection.

Note: *Since all networks are different, the parameters that you need to configure before being able to connect to the VPN may vary. For information on the configuration specific to your network, contact your network administrator.*



IMPORTANT

EXFO does not provide any VPN clients. You must either use one of the VPN clients available directly in Windows or provide the installation files for another VPN client yourself.

EXFO will not provide any support regarding the VPN clients or connection.



IMPORTANT

To avoid communication problems between the VPN client and the VPN server, ensure that the date set on your unit corresponds to the current date.

To add a VPN connection:

1. From the main window, tap the **System Settings** button.
2. Tap **Control Panel**.



3. Tap **Network and Internet**.

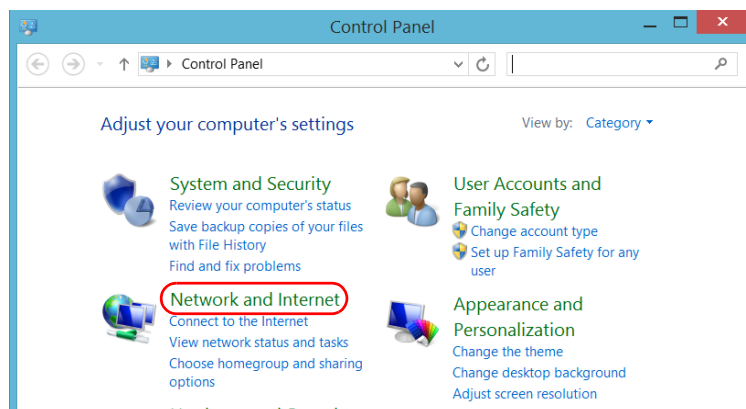

Managing Data

Connecting to a VPN from Your Unit

4. Under **Network and Sharing Center**, tap **View network status and tasks**.

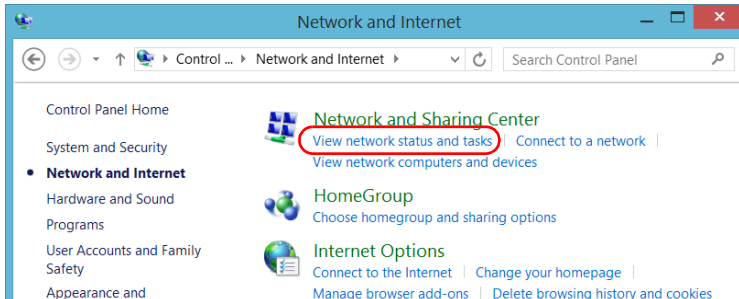

5. Tap **Set up a new connection or network**.

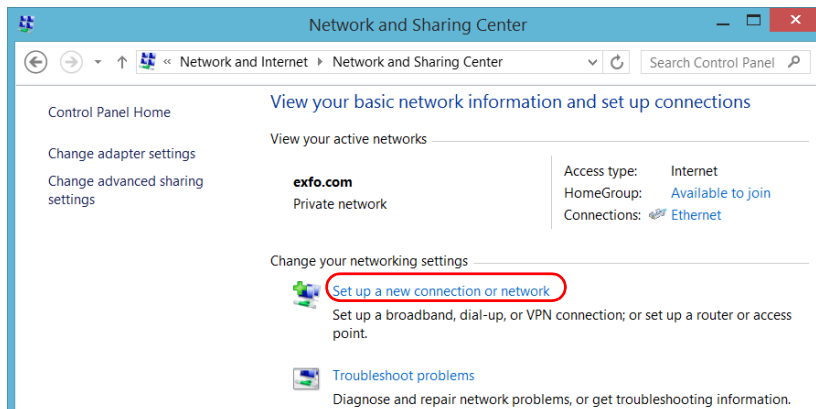

6. Tap **Connect to a workplace**, and then tap **Next**.

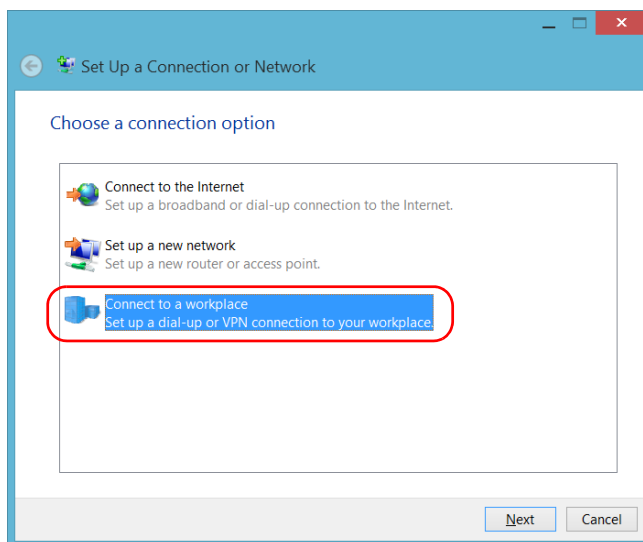

7. Follow the on-screen instructions.

Managing Data

Connecting to a VPN from Your Unit

To install a VPN client on your unit (Windows 10 and Windows 8.1 Pro only):

1. Start the installation of the VPN client using the files and settings provided by your network administrator.
2. Follow the on-screen instructions.

Once the installation is complete, all users will now be able to connect to a VPN from the unit.

To connect to a VPN from your unit:

1. From the main window, tap the **System Settings** button.
2. Tap **Control Panel**.



3. Tap Network and Internet.

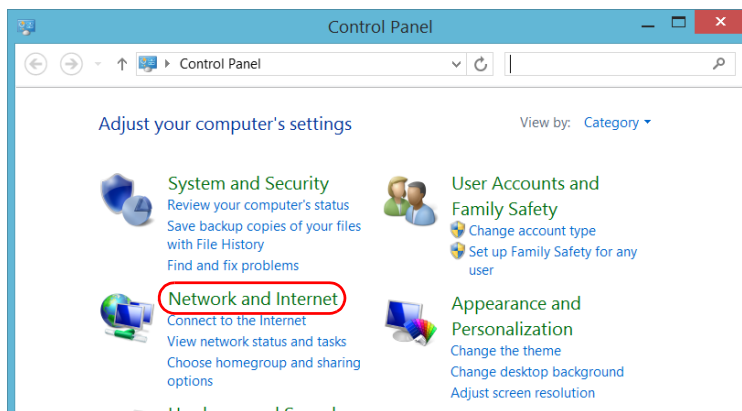

4. Under Network and Sharing Center, tap Connect to a network.

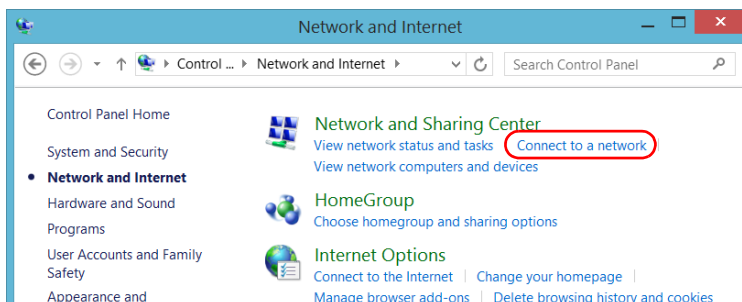

Managing Data

Connecting to a VPN from Your Unit

5. From the list displayed at the right of the screen, select the desired VPN connection.

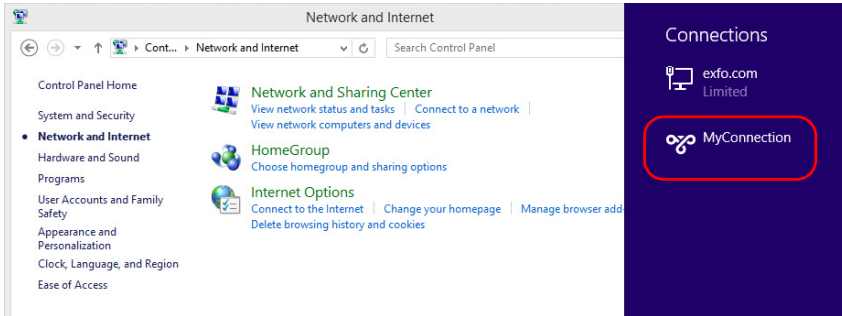

6. If your unit is running Windows 10, a new window will open. Select the desired VPN connection from the list.
7. Tap **Connect**.
8. Enter your sign-in information to the VPN, and then tap **OK**.

If you are not sure about the information that you should provide, contact your network administrator.

9 Accessing Your Unit Remotely

You can access your unit remotely from a computer using either the Remote Desktop Connection application or a VNC viewer.

This could be particularly useful if you do not intend to perform automation tasks on your platform. If you prefer to perform automation tasks on your platform and modules, see *Preparing for Automation* on page 233, *Using Your Unit and Modules in an Automated Test Environment* on page 275, or *Configuring Your Instruments* on page 266

The table below presents the differences between the two applications.

Characteristic	Remote Desktop Connection	VNC Viewer
Type of connection	Direct between the unit and the computer; only one user can be connected to the unit at a time. Usually, the connection is made with the user name of the person currently logged on the unit. Otherwise, this person will be automatically disconnected.	Not exclusive; several users can be connected to the unit at the same time (sharing the same session).
Windows user rights	Taken into account.	Not taken into account.
Password-protected	Yes; mandatory. The user name and password are the same as those used to connect to the unit. By default, all the accounts with administrator rights can use Remote Desktop Connection. If you want accounts with limited rights to be able to use Remote Desktop as well, you must specifically grant them access.	Yes; mandatory. You must define a password on the UltraVNC Server, the first time you start the server. By default, all people that use the UltraVNC Viewer (or another VNC viewer) will enter the same password (as defined on the server). Each user to whom you provide the password will be able to connect to the unit via VNC.

Working with Remote Desktop

By default, the remote access to your unit with Remote Desktop is not enabled. However, once you enable it, all the accounts with administrator rights can use Remote Desktop. If you want accounts with limited rights to be able to use it as well, you must specifically grant them access.

You can also configure the unit to prevent users from accessing it remotely.

Accessing Your Unit with Remote Desktop

To be able to connect to the unit using Remote Desktop, you must:

- Allow the remote access to your unit (only necessary the first time that you access your unit with Remote Desktop).
- Know the IP address of the unit and provide it in the connection settings on the computer.

Note: *If your unit and the computer are on the same network, you can even use the computer name of your unit, followed by its serial number. You can view the computer name of your unit from **System Settings > Remote Session > Computer Name**.*

- Use an account that is secured by a password. Remote Desktop will not allow any connection with empty passwords.
- Enter the appropriate user name when Remote Desktop application prompts you. Usually, this user name must correspond to the user name of the person currently logged on the unit. Otherwise, you will disconnect the person that was already connected.

To allow the remote access to your unit with Remote Desktop:

1. From the main window, tap the **System Settings** button.
2. Tap **Remote Session**.



3. Under **Remote Desktop**, select **Allow remote connections to this computer**.

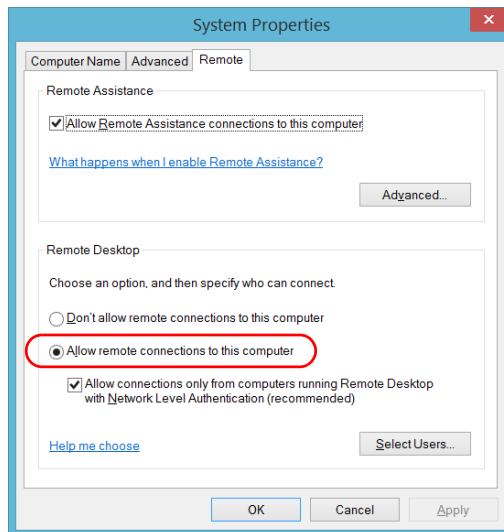

4. Tap **OK** to confirm the changes and return to the **System Settings** window.

Accessing Your Unit Remotely

Working with Remote Desktop

To access your unit remotely with Remote Desktop:

1. Connect both the computer and your unit to the same network and make sure they can “see” each other as network restrictions might prevent them from communicating.
 - If you want to use an Ethernet network, connect an RJ-45 (network) cable to the unit’s Ethernet (RJ-45) port located on its right panel.
 - If you want to use a wireless network, see *Connecting to a Wireless Network* on page 178.
2. Turn on both the computer and the unit.
3. On your unit, from Toolbox X, tap the  button (located at the bottom of the button bar).

4. Select the **Platform** tab, write down the IP address, and then close the window.

Note: *It may take a few seconds before you see the IP address on the list.*

5. From the computer, open the Remote Desktop Connection window.
 - If your computer runs Windows Vista or Windows 7: On the taskbar, click **Start**, then select **All Programs > Accessories > Remote Desktop Connection**.
 - If your computer runs Windows 8: On the taskbar, point the lower left corner, and then click the **Start** screen icon. Right-click the bottom of the screen, and then click **All apps**. Under **Windows Accessories**, select **Remote Desktop Connection**.
 - If your computer runs Windows 8.1 or Windows 10: On the taskbar, click the **Start** button (), then under **Windows Accessories**, select **Remote Desktop Connection**.
6. In the **Connecting to Remote Desktop** window, in the **Computer** list, type the IP address of the unit that you wrote down at step 4.

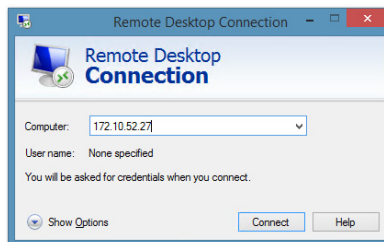

7. Click **Connect**.
8. When the application prompts you, enter your user name and password.
9. Click **OK** to open the session.

Accessing Your Unit Remotely

Working with Remote Desktop

Allowing Users with Limited Accounts to Use Remote Desktop

By default, only the accounts with administrator rights can use Remote Desktop. However, you can assign extra user rights to accounts with limited rights so that they can also use Remote Desktop.

To allow a user with limited accounts to use Remote Desktop:

1. From the main window, tap the **System Settings** button.
2. Tap **Remote Session**.

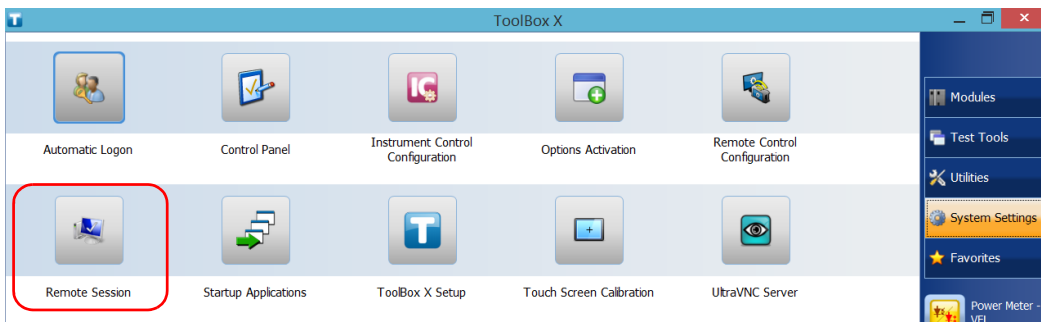

3. Under **Remote Desktop**, select **Allow remote connections to this computer**.

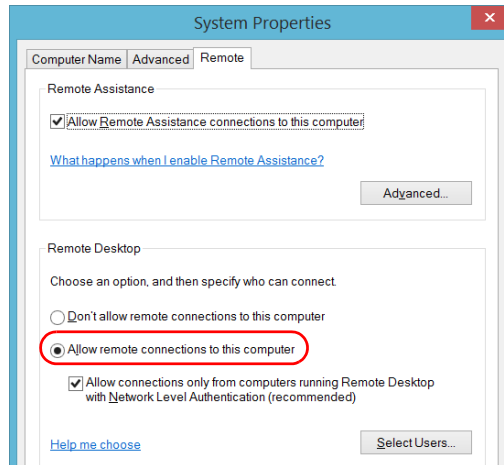

4. Tap **Select Users**.
5. From the **Remote Desktop Users** dialog box, tap **Add**.

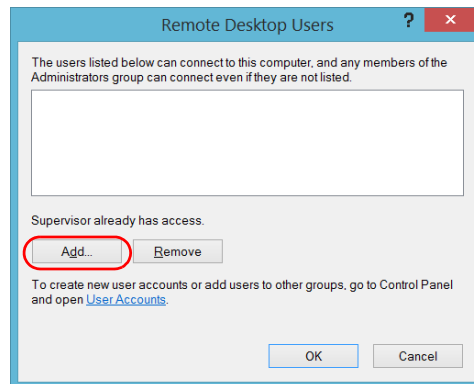

Accessing Your Unit Remotely

Working with Remote Desktop

- From the **Select Users** dialog box, tap **Advanced**.

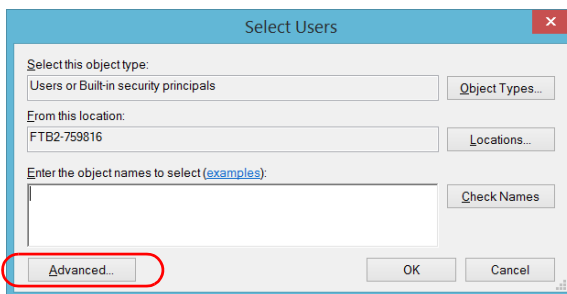

- Tap **Find Now** to let the system find and display the list of users.

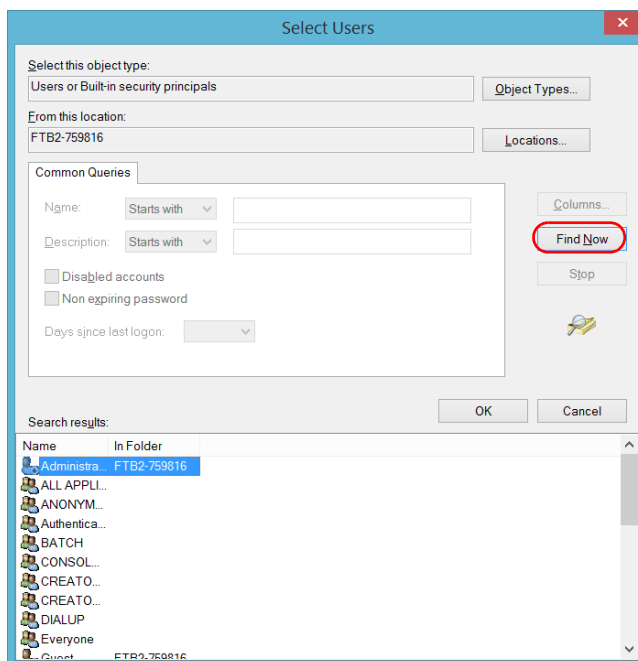

- Select the user to which you want to grant access rights, and then tap **OK**.

9. From the list of users, select the user that you have just added, and then tap **OK**.

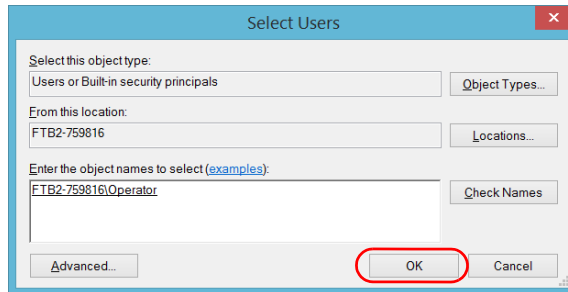

10. Repeat steps 7 to 9 with all the users to which you want to grant access rights.
11. From the **Remote Desktop Users** dialog box, tap **OK**.
12. From the **System Properties** dialog box, tap **OK** to confirm the changes and return to the **System Settings** window.

Accessing Your Unit Remotely

Working with Remote Desktop

Preventing Users from Connecting with Remote Desktop

You can also configure the unit to prevent users to access it using Remote Desktop. However, all users having administrator user rights will be able to modify this setting at any time.

To prevent users from connecting to the unit using Remote Desktop:

1. From the main window, tap the **System Settings** button.
2. Tap **Remote Session**.



3. Under **Remote Desktop**, select **Don't allow remote connections to this computer**.

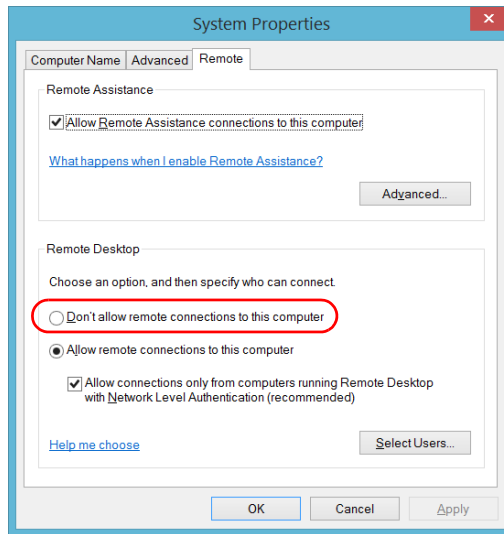

4. Tap **OK** to confirm the changes and return to the **System Settings** window.

Working With VNC

The control of your unit with VNC requires a VNC server (already installed on your unit) and a VNC viewer (that you must install on your computer).

To be able to connect to the unit using VNC, you must:

- Know the IP address of the unit and provide it in the connection settings on the computer.
- Know the password (same for all users by default).

This section provides you with the basic information to control your unit with VNC.

Configuring the VNC Server

The UltraVNC Server is already installed on your unit. By default, the server is configured to accept secured connections only. This means that you must configure a password before establishing a connection between a computer and your unit.

You can modify various connection settings to better suit your needs.

To configure the VNC Server:

1. From the main window, tap the **System Settings** button.
2. Tap **UltraVNC Server**.

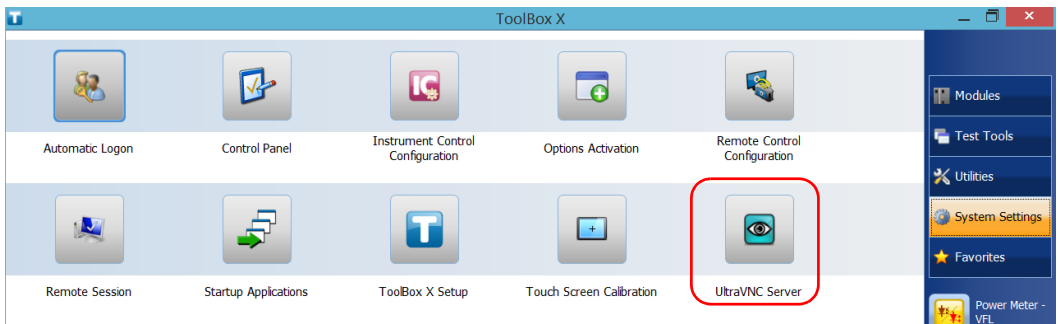

3. From the notification area, right-click the UltraVNC icon.



4. From the shortcut menu, tap **Admin Properties**.

Accessing Your Unit Remotely

Working With VNC

- Depending on the type of connection that you want, under **Authentication**, enter a value in the **VNC Password** or **View-Only Password** box.

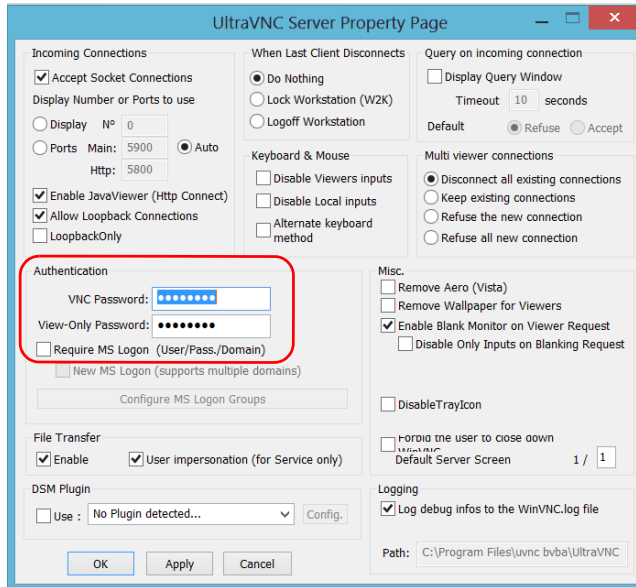

Note: The VNC and view-only passwords are independent of each other. They do not have to be identical.

- Tap **Apply**, and then **OK**.

Installing the VNC Viewer on a Client Computer

If no VNC viewer is already installed on your computer, you can download the UltraVNC Viewer from the Web for free.



IMPORTANT

EXFO does not provide licenses for UltraVNC Viewer. Always ensure that you are entitled to install it on your computer.

To install the UltraVNC Viewer on your computer:

1. Open a Web browser and go to <http://www.uvnc.com/downloads/ultravnc.html>.
2. Download the version of the viewer that corresponds to the operating system that your computer is running.
3. Double-click the file that you have just downloaded to start the installation.
4. Follow the on-screen instructions.

Connecting to Your Unit with VNC

Once the UltraVNC Viewer is installed on your computer, you are ready to access your unit remotely.

To connect to your unit with UltraVNC:

1. Connect both the computer and your unit to the same network and make sure they can “see” each other as network restrictions might prevent them from communicating.
 - If you want to use an Ethernet network, connect an RJ-45 (network) cable to the unit’s RJ-45 port located on its right panel.
 - If you want to use a wireless network, see *Connecting to a Wireless Network* on page 178.
 - You can also create a Private Area Network with your Bluetooth® device (see *Transferring Data Using the Bluetooth Technology* on page 171).
2. Turn on both the computer and the unit.
3. On your unit, ensure that ToolBox X is open.
4. At the bottom of the button bar, tap .

5. Tap **Platform**.
6. Scroll down until you can see the IP address.

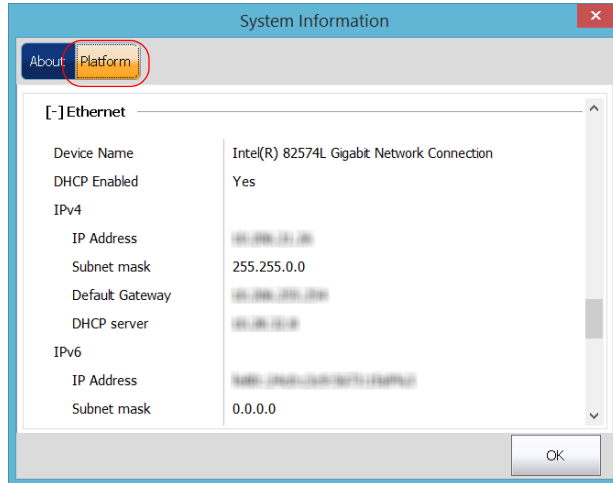

7. Write down the IP address, and then close the window.

Note: *It may take a few seconds before you see the IP address on the list.*

Accessing Your Unit Remotely

Working With VNC

- From the main window, tap the **System Settings** button.
- Tap **UltraVNC Server** to start the server.



Note: For security reasons, the UltraVNC Server is not started automatically. However, if you prefer that your unit remains ready for remote connections at all times, you can install the corresponding service (right-click the UltraVNC icon, and then tap **Install Service**). Refer to the Web site of UltraVNC (<http://www.uvnc.com>) for more information.

- From your computer, start the UltraVNC Viewer.

- 11.** In the **VNC Server** list, type the IP address of your unit that you wrote down at step 7.

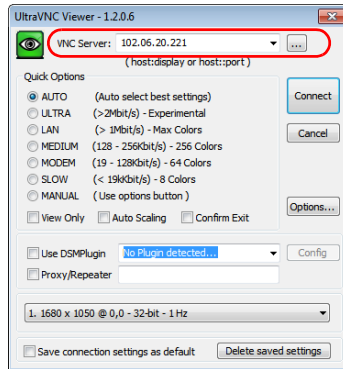

Note: *The appearance of the UltraVNC Viewer window may vary depending on the version of the viewer that you have.*

- 12.** Click **Connect**.
- 13.** When the application prompts you for a password, enter it and click **OK** to confirm.

Adding Exceptions to the Firewall

Note: Only administrator-level users can add exceptions to the firewall.

Your unit is protected by the Microsoft firewall to prevent unauthorized access when it is connected to a network or to the Internet. The firewall has been preconfigured so that all the applications that come with your unit work properly. However, you can allow other applications to access the network or the Internet by adding exceptions.

If you are not sure about how to configure the firewall, contact your network administrator.

To add exceptions to the firewall:

1. From the main window, tap the **System Settings** button.
2. Tap **Control Panel**.

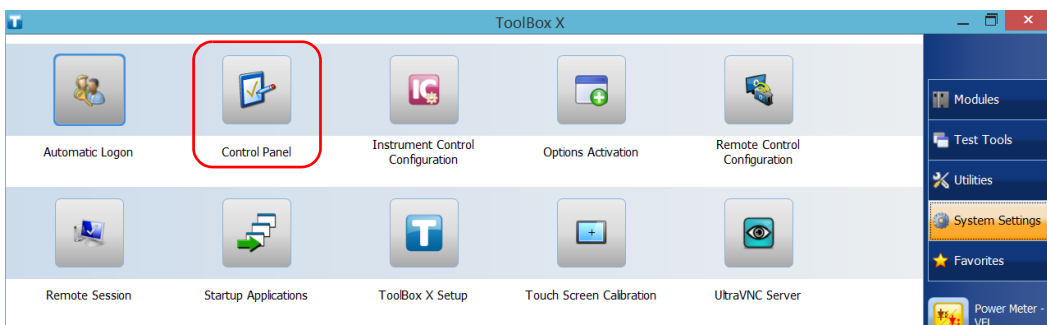

3. Tap **System and Security**.

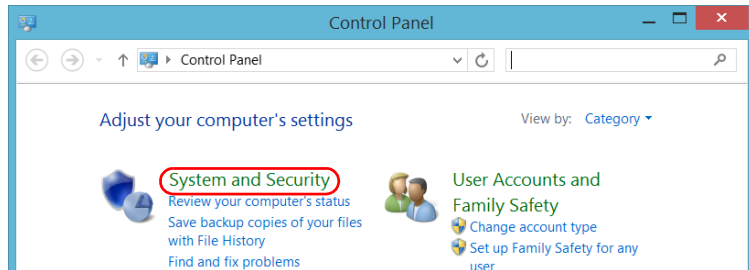

4. Under **Windows Firewall**, tap **Allow an app through Windows Firewall**.

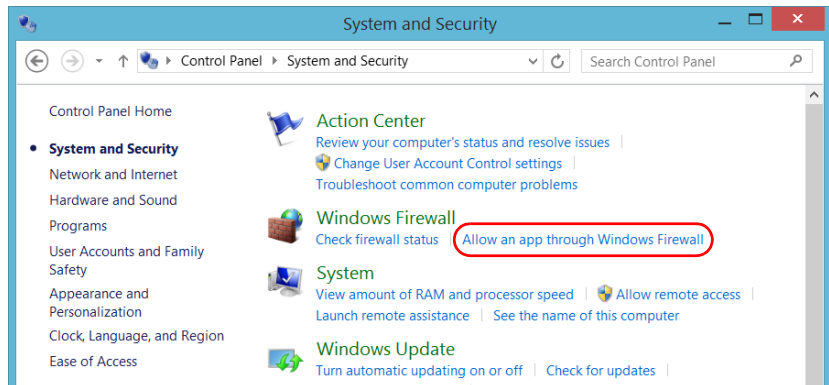

5. Tap the **Change settings** button.

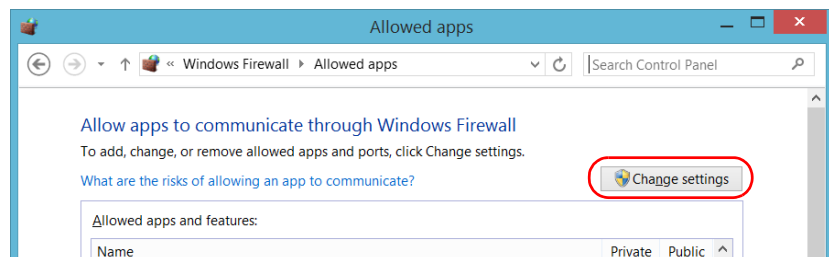

Accessing Your Unit Remotely

Adding Exceptions to the Firewall

6. Tap the **Allow another app** button.

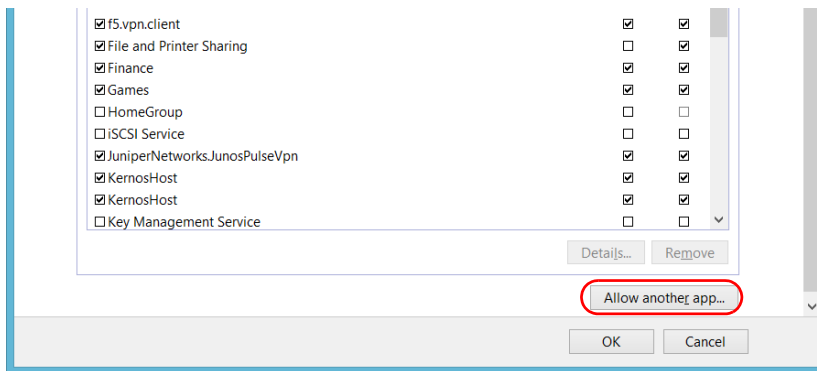

7. Select the desired application from the list, and then tap **Add**.

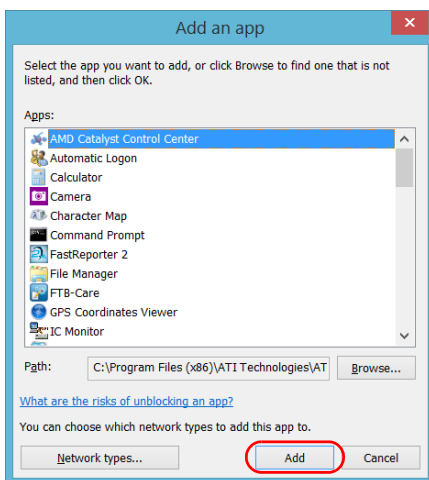

8. Ensure that the **Private** and **Public** settings of the added application suit your needs.

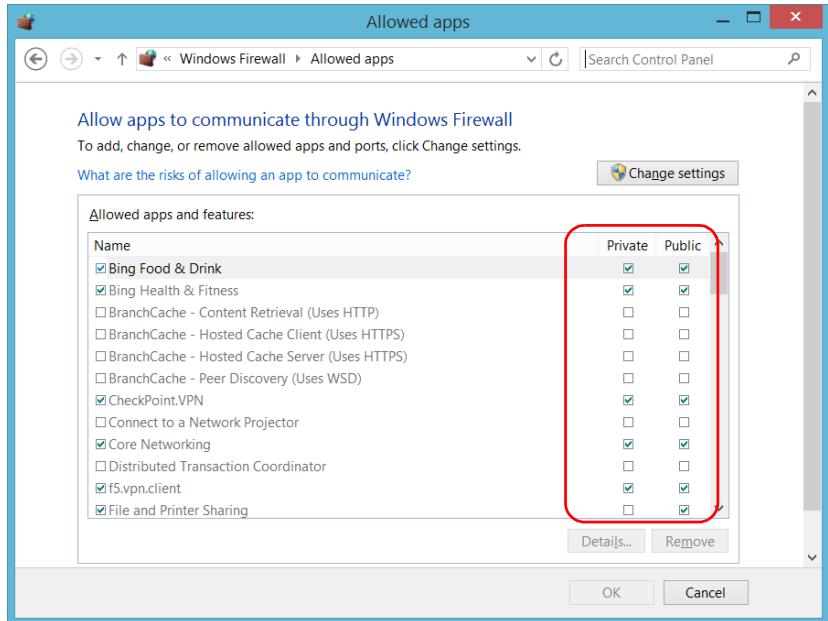

9. When you have finished, tap **OK** to confirm the changes and return to the **Control Panel** window.

10 Testing Network Connections

Note: This function is available with the optional IPT software package only.

The two most common basic tests widely used in networking are the *ping* test and the *trace route* test. With these tests, you can ensure that IP packets travel as expected from a local host to a remote host and vice versa.



IMPORTANT

To avoid misleading results, always ensure that your unit is only connected to one network at a time (either standard Ethernet or wireless network) before performing ping or trace route tests.

Performing a Ping Test

The ping test is a basic test that measures the average time it takes for a packet to reach the remote host. With this test, you can quickly verify that the remote host functions properly.

The ping test has six common parameters:

- The URL (IP address)
- The number of packets to send
- The packet size
- The maximum time allowed for a packet to reach the remote host
- The maximum number of hops allowed for reaching the remote host (TTL)
- A flag to indicate whether a packet can be fragmented.

When the test is complete, you can export the results. You can later import the generated text file (tab-delimited) directly into Microsoft Excel.

Testing Network Connections

Performing a Ping Test

To perform a ping test:

1. From the main window, tap **Test Tools**.
2. Tap **IP Tools**.

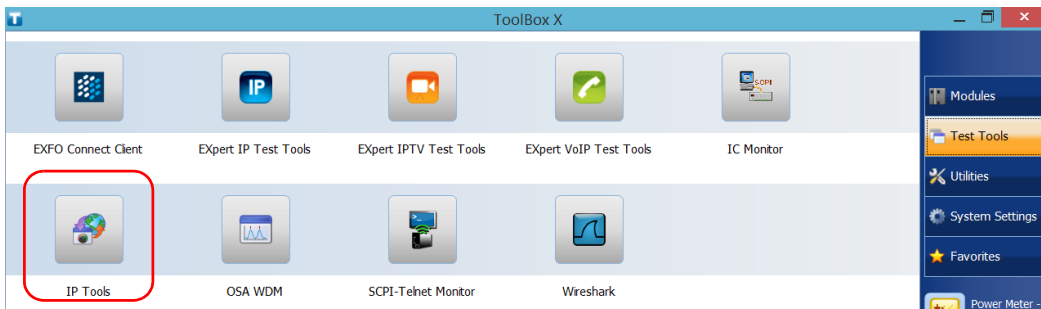

3. From **IP Testing Tools**, select the **Ping** tab.

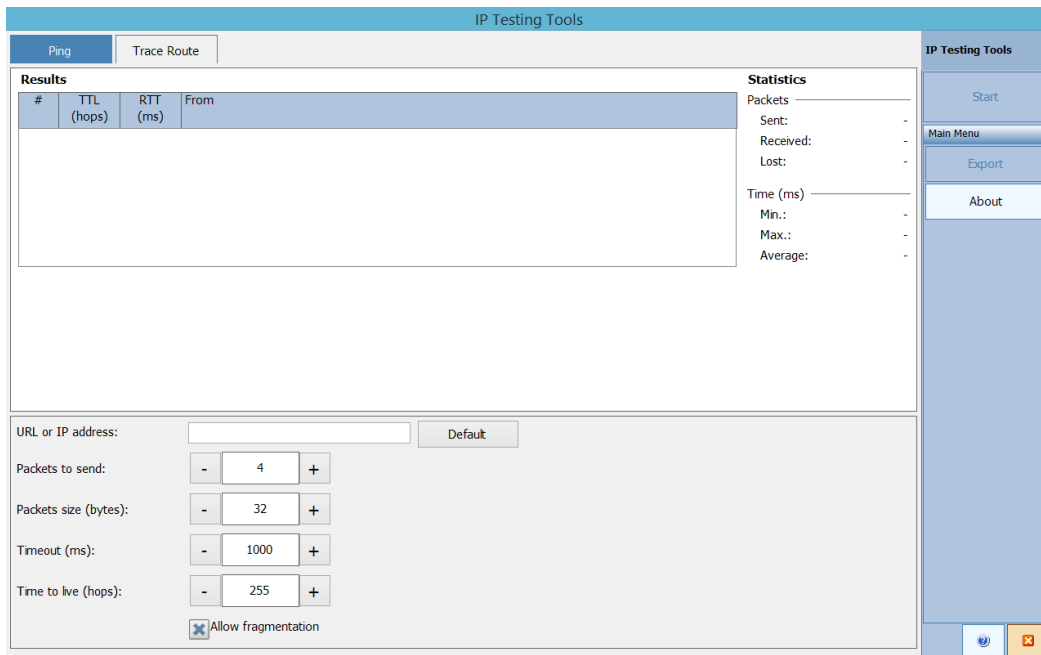

4. Enter a URL or an IP address to reach. You can tap the **Default** button to use the unit's default ping address. The default value cannot be configured.
5. Set the other parameters:
 - Number of packets to send
 - Packet size
 - Timeout limit
 - TTL limit
 - Clear the **Allow fragmentation** check box if you prefer sending complete packets to the host.
6. Tap the **Start** button.

You can stop a ping test at any time by tapping the **Stop** button.

Performing a Trace Route Test

The trace route test is used to evaluate the average number of nodes that are required to reach the final host. It is often used to troubleshoot networks (identify accesses blocked by firewalls or routing problems).

This trace route test utility enables you to:

- Enter a remote host address.
- Set the maximum time allowed for a packet to reach the remote host.
- Set the maximum number of hops allowed for reaching the remote host (TTL).
- Choose whether to resolve DNS for the IP address or not.

When the test is complete, you can export the results. You can later import the generated text file (tab-delimited) directly into Microsoft Excel.

To perform a trace route test:

1. From **IP Testing Tools**, select the **Trace Route** tab.
2. Enter an URL or an IP address to reach. You can tap the **Default** button to use the unit's default trace route address. The default value cannot be configured.

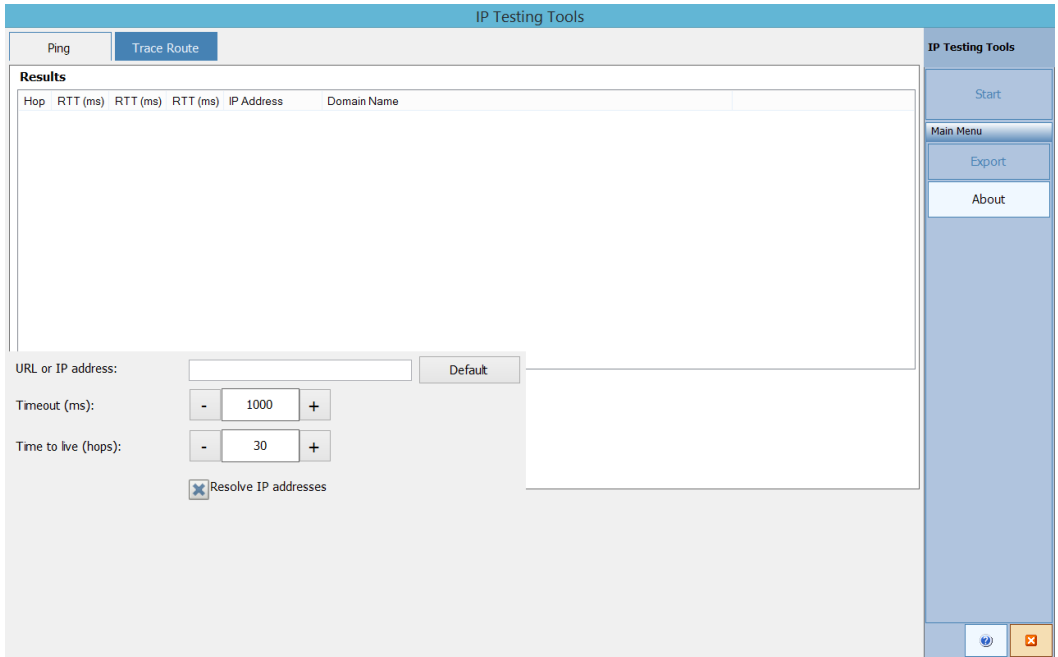

3. Set the other parameters:
 - Timeout limit
 - TTL limit
 - Select or clear the **Resolve IP addresses** check box if you want to get the host name for the corresponding IP address of nodes.
4. Tap the **Start** button.

You can stop a trace route test at any time by tapping the **Stop** button.

Exporting the Results

When a test is complete, you can export the results of the current test page. If you want to keep your results for future use, you must export them because result files cannot be opened directly from your unit.

Results are sent to a text file. Fields are separated by the “TAB” character to simplify the importation into a Microsoft Excel worksheet.

By default, the application suggests a file name:

- For ping tests:

Ping for [URL] on [YEAR]_[MONTH]_[DAY].txt

- For trace route tests:

Trace Route for [URL] on [YEAR]_[MONTH]_[DAY].txt

Where:

- [URL] is the entered URL or IP address,
- [YEAR] is the year of the test,
- [MONTH] is the month of the test,
- [DAY] is the day of the test.

Example:

For a ping test at www.yoursite.org made on July 3rd, 2014, the suggested filename would be:

Ping for www.yoursite.org on 2014_07_03.txt

To export results:

Tap the **Export** button. If necessary, modify the suggested file name.

11 Preparing for Automation

Your unit was designed to meet the requirements of automation and to facilitate its integration with your test environment.

Note: *To have access to automation features on an FTB-2 unit, you must purchase the Automation option.*

EXFO supplies commands that follow the guidelines determined by the SCPI consortium for many instruments. EXFO also supplies COM properties and events allowing you to build your own application. The instruments can be controlled either locally or remotely via the following technologies:

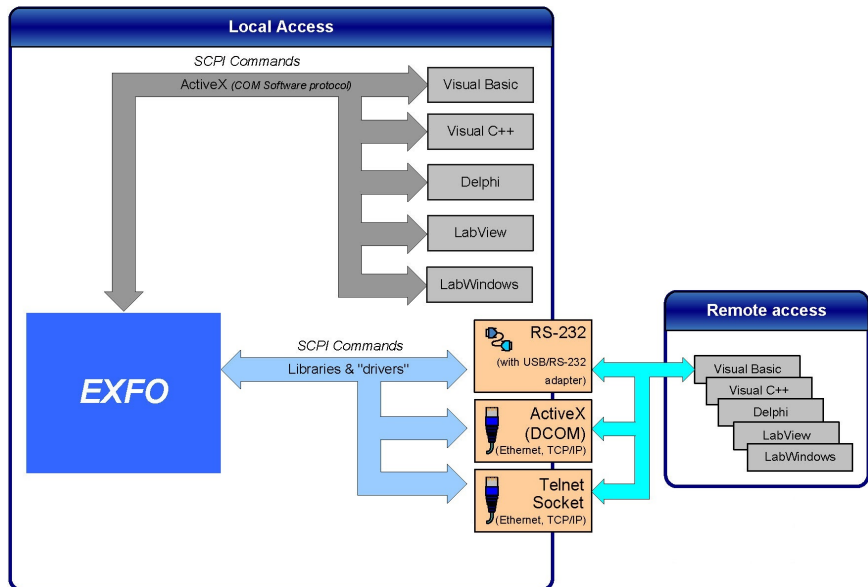

Preparing for Automation

The choice of a technology depends on your particular needs.

Communication	Characteristics
ActiveX (COM)	<ul style="list-style-type: none">➤ Allows you to develop an application that will run locally on your unit within Windows.➤ Best approach when speed is your top priority (no physical connection that slows down the process).➤ Supported by most development software.➤ Lower cost.
ActiveX (DCOM) (Ethernet, TCP/IP)	<ul style="list-style-type: none">➤ Allows the sharing of network resources.➤ Allows you to develop computer-based applications to directly communicate with your unit.
RS-232	<ul style="list-style-type: none">➤ USB to RS-232 adapter (purchased from EXFO) required to establish connection between the computer and your unit.➤ For increased speed and performance, run the application locally on your unit through ActiveX instead of using RS-232.
Telnet and Socket (Ethernet, TCP/IP)	<ul style="list-style-type: none">➤ Your unit can be directly connected to a Local Area Network (LAN) or Wide Area Network (WAN) via its 10/100/1000 Base-T interface.➤ Allows the sharing of network resources.➤ Allows you to develop computer-based applications very easily to directly communicate with your unit.➤ Telnet allows you to send SCPI commands over the Telnet service.➤ Socket allows you to send the same SCPI commands as you would in Telnet, but without any formatting (raw communication). The socket communication is similar to a communication by RS-232, but over a LAN connection.

For more information on programming aspects, see the section on using your product in an automated test environment.

Linking Units with the Ethernet Port

Your unit is equipped with an Ethernet port (10/100/1000) to send and receive data. Refer to the Windows documentation for information about Ethernet port settings and possibilities.

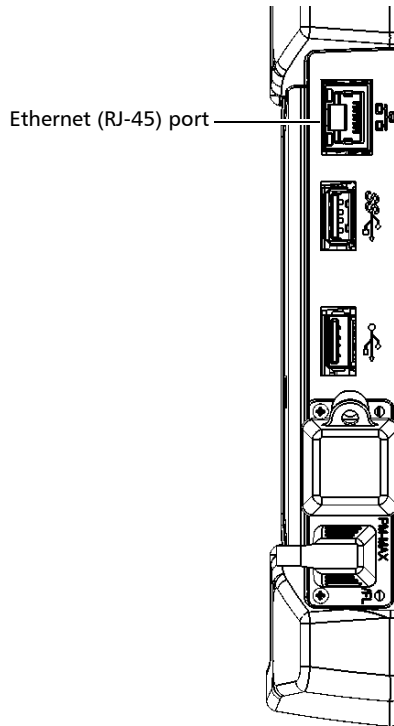

Linking Units Using a Serial Port

Your unit is not equipped with a serial (RS-232) port, but you can connect a USB to RS-232 adapter (sold by EXFO) to your one of the USB ports of your unit if you wish to send and receive data via RS-232.

Getting Optimum Performance from Your Unit

Several factors influence the data transfer rate of your unit. The information presented hereafter will help you get the best transfer rate possible.

- *Output unit (RS-232, ActiveX and TCP/IP):* Your unit can return results in
 - linear units (for example, watts)
 - log units (for example, dBm)

Since internal units are linear, you will get optimal performance by using linear units for output (no need for an internal conversion to log).

Note: *You must make the choice of output unit for each instrument offering such a feature. Refer to the user guide of each optical instrument for a list of available commands and queries.*

- *Output format (RS-232, ActiveX and TCP/IP):* Your unit provides the following output formats for measurement results:
 - ASCii
 - PACKed

Generally, the PACKed format allows to pass three to four times more information than the ASCii format for the same transfer rate. Often, the PACKed format is also more efficient since it reduces your unit's CPU work load (no need for an internal conversion to ASCII format).

Note: *The PACKed format will only be applied to <DEFINITE LENGTH ARBITRARY BLOCK RESPONSE DATA> and <INDEFINITE LENGTH ARBITRARY BLOCK RESPONSE DATA>.*

Note: *The choice of data format cannot be made directly via the ToolBox X software.*

For more information on how to set the output format and data types, see *:FORMat[:DATA](IEEE 488.2 and specific commands appendix)*, *Read* and *ReadBinary* (COM properties and events appendix), and the data types appendix.

Preparing for Automation

Changing Communication Settings

Changing Communication Settings

Communication settings cannot be modified without turning on your unit and starting ToolBox X.

To change communication settings:

1. Tap the **System Settings** button, then tap **Instrument Control Configuration**.

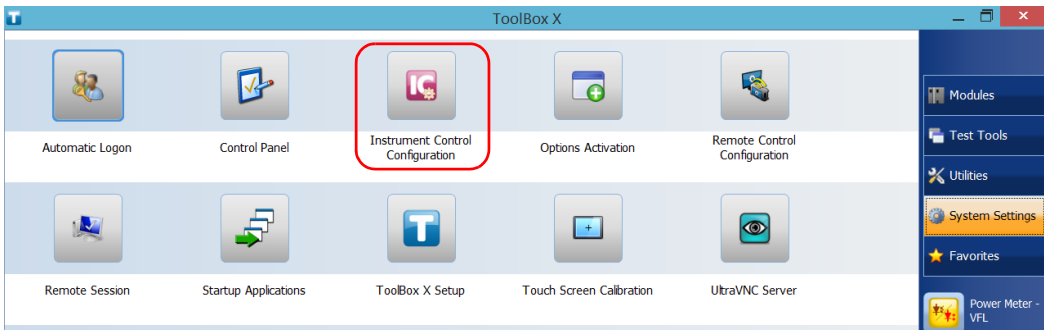

2. Tap **Change settings**, and then, when the application prompts you to authorize the changes to your unit, tap **Yes**.

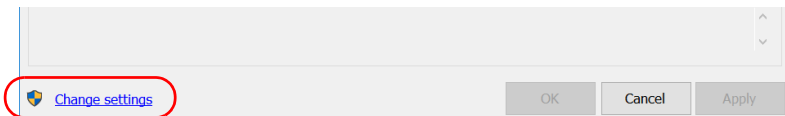

3. If you want to send SCPI commands to your modules, select the **Allow automation on instruments** check box. Clear the check box if you prefer to block automation on your unit.

Note: *If you allow automation, all modules in your unit will be initialized upon startup so you are ready to send remote commands.*



IMPORTANT

Before being able to control instruments with SCPI commands, you must also allow remote access to these instruments. For more information, see *Configuring Your Instruments* on page 266.

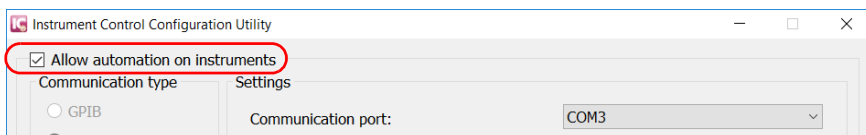

If you cleared the check box because you prefer to block automation, you can go directly to step 6.

Preparing for Automation

Changing Communication Settings

4. Under **Communication Type**, select **ActiveX**, **RS-232**, or **TCP/IP**.

For more information on the choice of a particular type, see the table on page 234.

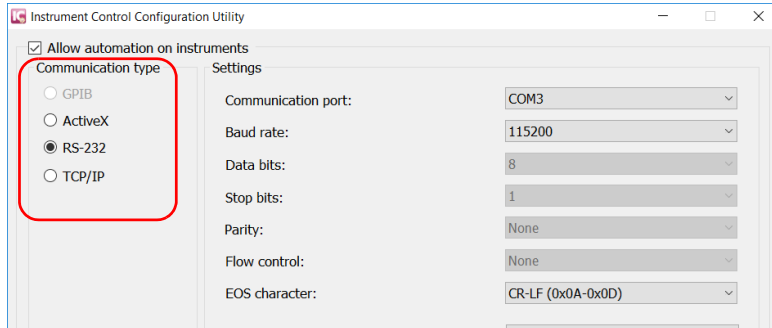

Note: *If the selected communication type does not match the protocol that will actually be used, an error message is displayed when attempting to control the instruments.*

5. According to the communication type you have selected, if necessary, customize the corresponding parameters.

- For RS-232

Serial port—used to connect the RS-232 cable.

Determines the speed at which data is sent between the unit and a computer, in bits per second (b/s).

End-of-string (EOS) character—used to indicate the end of a data string (when sending or receiving data).

Setting	Value
Communication port:	COM3
Baud rate:	115200
Data bits:	8
Stop bits:	1
Parity:	None
Flow control:	None
EOS character:	CR-LF (0x0A-0x0D)

- For TCP/IP (configuration set automatically for you)

Port 5024—used to connect over Telnet.

Port 5025—used for socket (raw) connections; compatible with IVI drivers.

Setting	Value
SCPI-Telnet (Port 5024)	
SCPI-Socket (Port 5025)	

Note: When you select TCP/IP, you can send SCPI commands on both ports (Telnet and Socket) simultaneously.

For information on communicating with TCP/IP over Telnet, see the section pertaining to communication through TCP/IP over Telnet.

6. Tap **Apply** to confirm your changes.

Preparing for Automation

Changing Communication Settings

To revert to default RS-232 settings:

1. Tap the **Default settings** button.

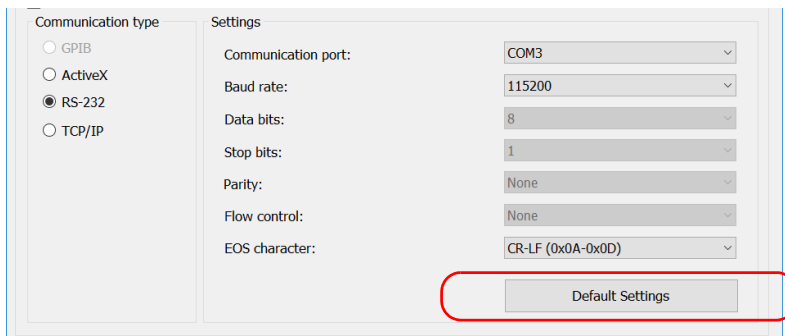

The screenshot displays a settings window with two main sections: 'Communication type' and 'Settings'. In the 'Communication type' section, four radio buttons are visible: GPIB, ActiveX, RS-232 (which is selected), and TCP/IP. The 'Settings' section contains several dropdown menus for: Communication port (COM3), Baud rate (115200), Data bits (8), Stop bits (1), Parity (None), Flow control (None), and EOS character (CR-LF (0x0A-0x0D)). At the bottom right of the settings area, a button labeled 'Default Settings' is highlighted with a red rounded rectangle.

2. Tap **Apply** to confirm your changes.

Configuring DCOM Access to Your Unit

DCOM technology allows to control devices and optical instruments via Ethernet. The EXFO IcSCPIAccess Class component provided with your unit acts as a communication link between a client application and EXFO's Instrument Control. For more information, refer to the EXFO Remote Control Demo available in EXFO Apps, at <http://www.exfo.com/software/exfo-apps/exfo-remote-control-demo>.

DCOM ensures communication between the client application and Instrument Control via your local network. Since each network has its own configuration, you need to be familiar with network security, users, groups, domain management, etc. Basic programming skills are also required to work with DCOM. For more information, you can refer to the Microsoft MSDN Help feature, which provides exhaustive technical documentation on all DCOM issues.

The example presented in the following pages illustrates how to make the EXFO IcSCPIAccess Class component available to all users of a local network. The example provided below is for guidance only; it may not work properly with all networks and interfaces may slightly differ depending on the operating system used.

To enable DCOM access to your unit, you must:

- set the general security parameters
- customize the specific security parameters
- register callback events.

Preparing for Automation

Configuring DCOM Access to Your Unit

Setting the General Security Parameters

Note: To modify the security parameters, you need administrator access rights.

To set the general security parameters:

1. From the main window, tap the **System Settings** button.
2. Tap **Control Panel**.
3. Tap **System and Security > Administrative Tools**.
4. Double-tap **Component Services**.
5. In the **Component Services** dialog box, go to **Console Root > Component Services > Computers**.

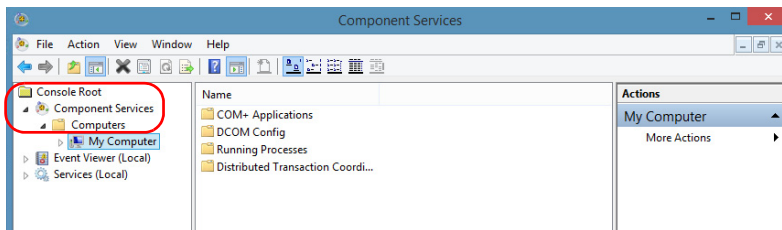

6. Right-click **My Computer**, and then select **Properties**.

7. In the **My Computer Properties** dialog box, tap the **COM Security** tab.
8. Under **Access Permissions**, tap **Edit Limits**.

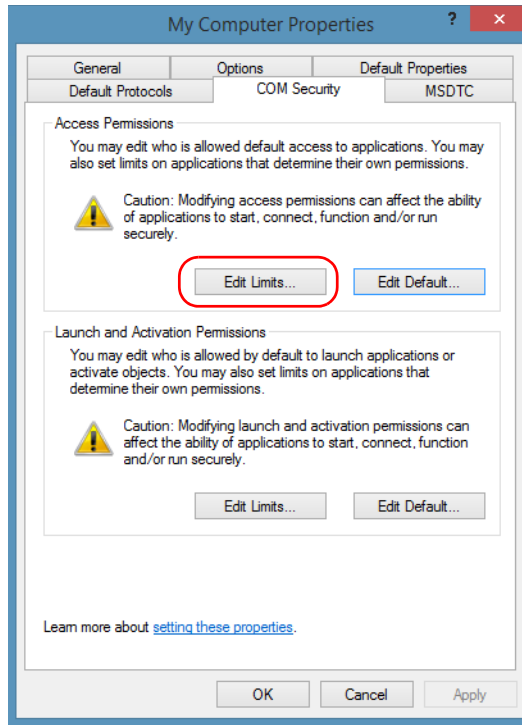

Preparing for Automation

Configuring DCOM Access to Your Unit

9. In the **Access Permission** dialog box, ensure that the **Distributed COM Users** appears in the **Group or user names** list.

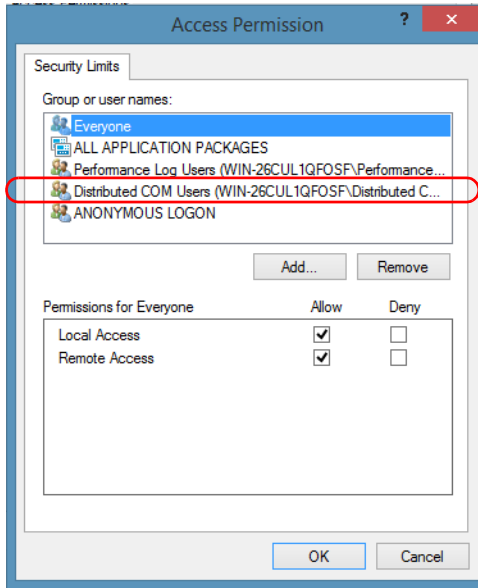

10. Tap **OK**.

11. In the **My Computer Properties** dialog box, tap the **COM Security** tab.

12. Under **Launch and Activation Permissions**, tap **Edit Limits**.

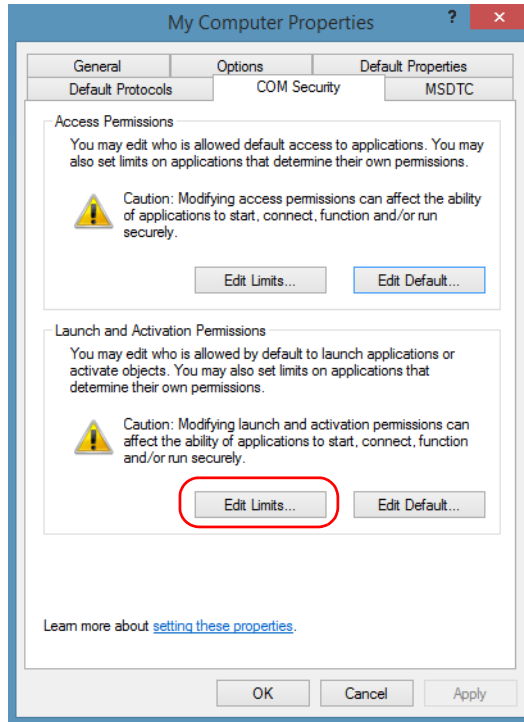

Preparing for Automation

Configuring DCOM Access to Your Unit

13. In the **Access Permission** dialog box, ensure that the **Distributed COM Users** appears in the **Group or user names** list.

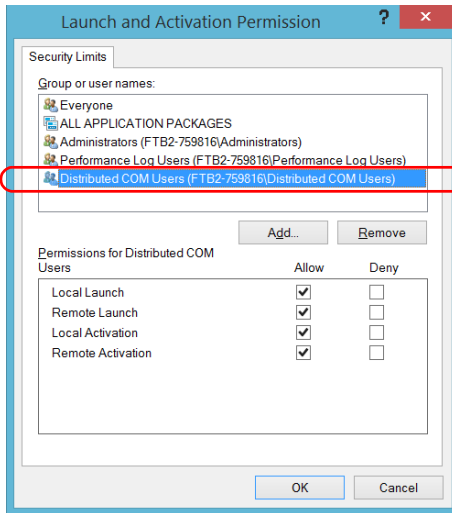

You can now allow users to access general DCOM services on your unit. You can either:

- Add a user to the **Distributed COM Users** group (refer to Microsoft help).
- OR
- Add a user explicitly and define both, access and launch permissions (see procedure below).

Note: *If you add a user explicitly, ensure to give remote access rights to the new user.*

To add a user explicitly:

1. In the **My Computer Properties** dialog box, tap the **COM Security** tab.
2. Under **Access Permission**, tap **Edit Limits**.
3. In the **Access Permission** dialog box, tap **Add**.

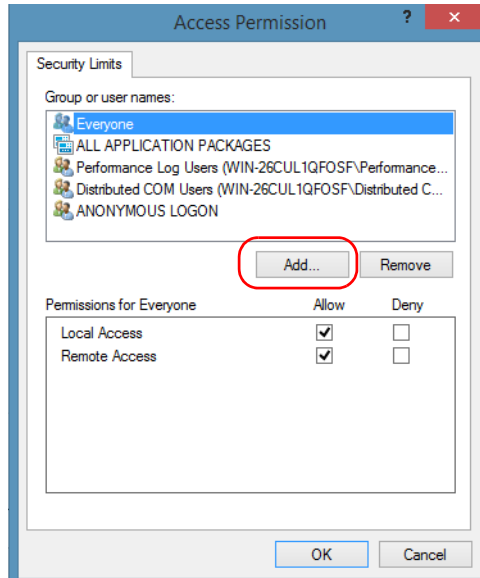

Preparing for Automation

Configuring DCOM Access to Your Unit

4. In the **Select Users or Groups** dialog box, under **Enter the object names to select**, type the name of the user to whom you want to give access rights.

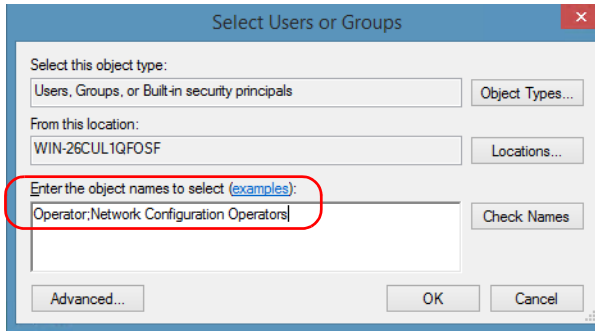

5. Tap **OK**.

6. Confirm the newly added user has remote access permission as follows:
 - 6a. In the **Access Permission** dialog box, select the name of the new user.

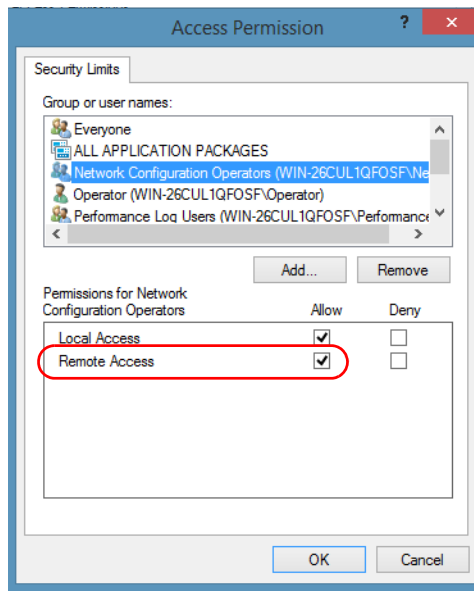

- 6b. Under **Permissions for** (new user), ensure **Allow** is selected for **Remote Access**.
 - 6c. Tap **OK**.
7. In the **My Computer Properties** dialog box, tap the **COM Security** tab.
8. Under **Launch and Activation Permissions**, tap **Edit Limits**.

Preparing for Automation

Configuring DCOM Access to Your Unit

9. In the **Launch and Activation Permission** dialog box, tap **Add**.

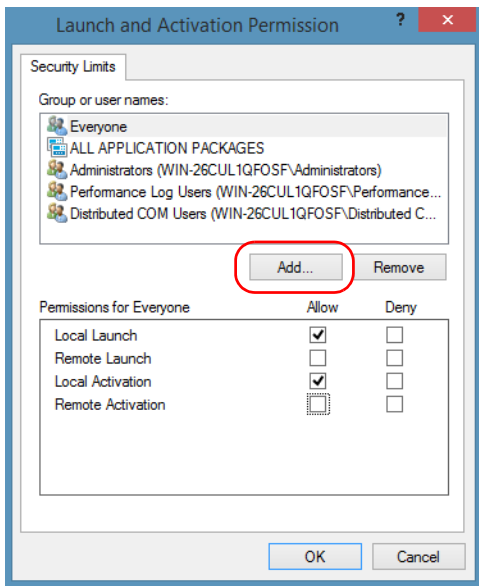

10. In the **Select Users or Groups** dialog box, under **Enter the object names to select**, type the name of the user to whom you want to give start and activation access rights.

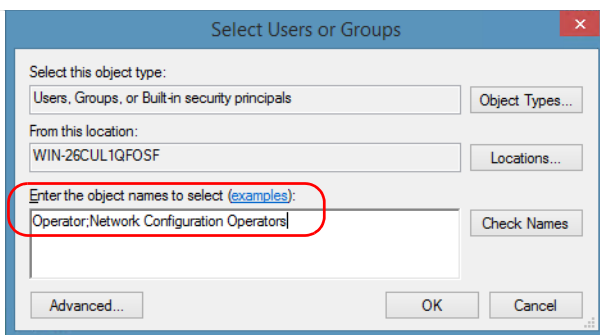

11. Tap **OK**.

12. Confirm the newly added user has **Remote Launch** and **Remote Activation** permissions as follows:

12a. In the **Launch Permission** dialog box, select the name of the new user.

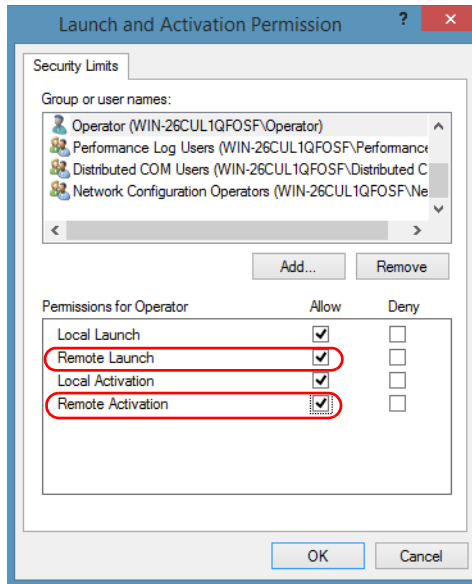

12b. Under **Permissions for** (new user), ensure **Allow** is selected for both **Remote Launch** and **Remote Activation**.

12c. Tap **OK**.

Customizing the Specific Security Parameters

Once you have defined the general security parameters, you can define the specific security parameters.



IMPORTANT

Customizing access rights sets both remote AND local permissions. As a result, you will have to specify every user who must have local access to the system (see *Setting the General Security Parameters* on page 244).

If you do not specify local access rights, no user will be able to access EXFO KernosHost and, therefore, no user will be able to start ToolBox X.

To customize the specific security parameters:

1. From the **Component Services** window, select: **Console Root > Component Services > Computers > My Computer > DCOM Config** to show the contents of the **DCOM Config** folder.

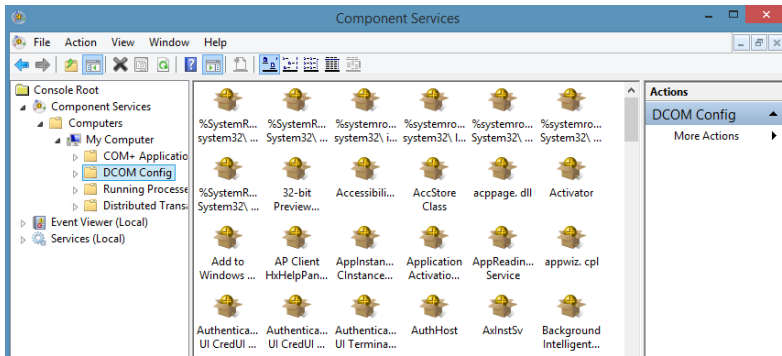

2. From **DCOM Config**, right-click **EXFO KernosHost**, and select **Properties**.

3. Tap the **General** tab.
4. In the **Authentication Level** list, select **Default**.

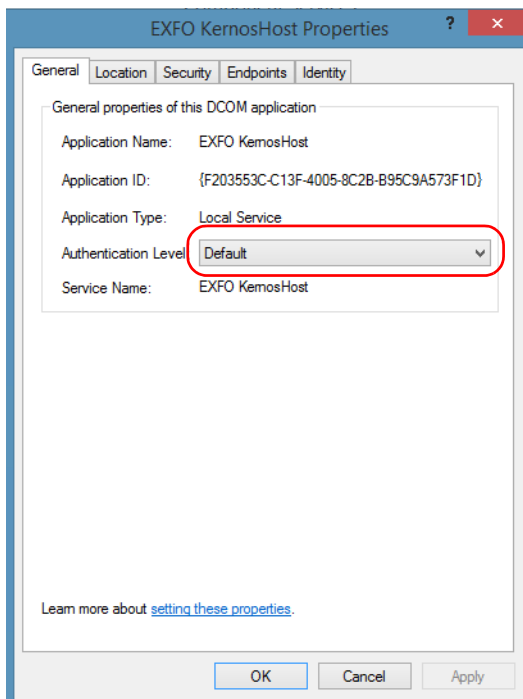

Preparing for Automation

Configuring DCOM Access to Your Unit

5. In the **EXFO KernosHost Properties** dialog box, tap the **Security** tab.
6. Under **Launch and Activation Permissions**, select **Customize**, and then click **Edit** to edit the list of allowed users.

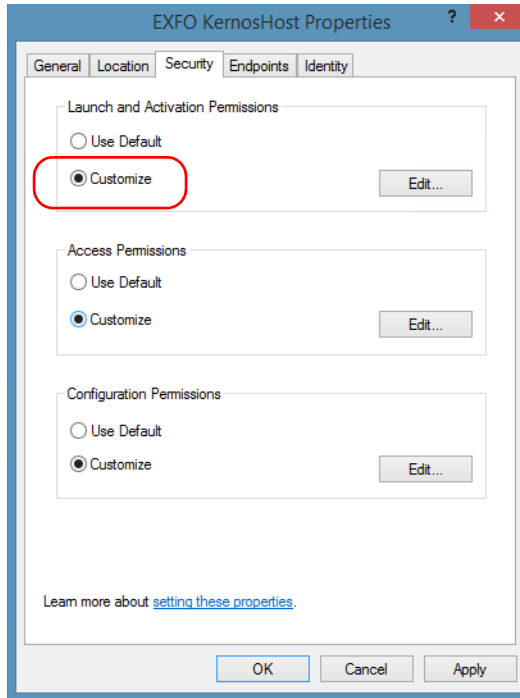

7. In the **Launch and Activation Permission** dialog box, tap **Add**.

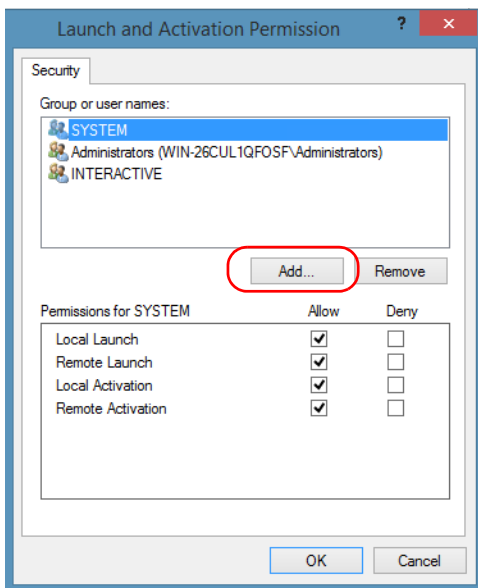

8. In the **Select Users or Groups** dialog box, under **Enter the object names to select**, type the name of the user to whom you want to give start and activation permissions for remote access.

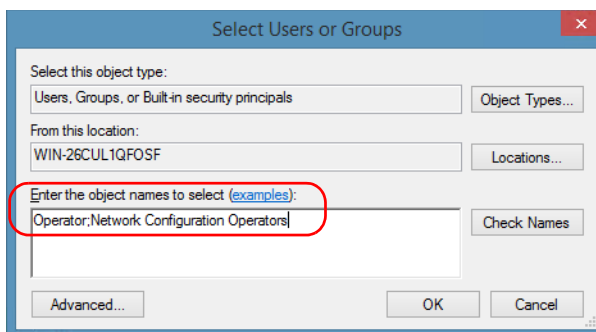

9. Tap **OK**.

Preparing for Automation

Configuring DCOM Access to Your Unit

- 10.** In the **Launch and Activation Permission** dialog box, select a user.
- 11.** To allow this user to start and activate the unit remotely, select **Allow** for all four permission choices.

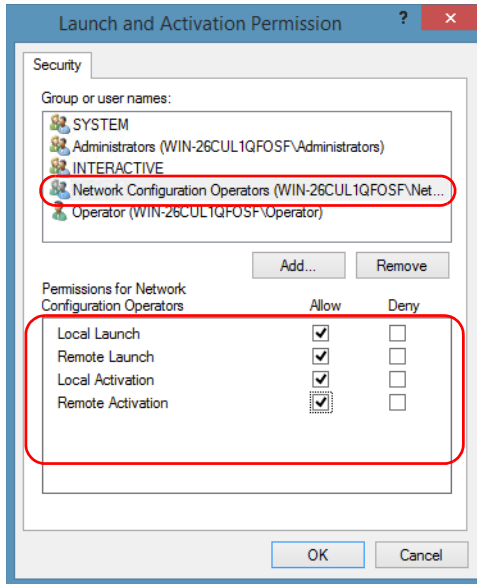

- 12.** Repeat steps 10 and 11 for each newly added user.
- 13.** Tap **OK**.

- 14.** In the **EXFO KernosHost Properties** dialog box, tap the **Security** tab.
- 15.** Under **Access Permissions**, select **Customize**, and tap **Edit** to edit the list of allowed users.

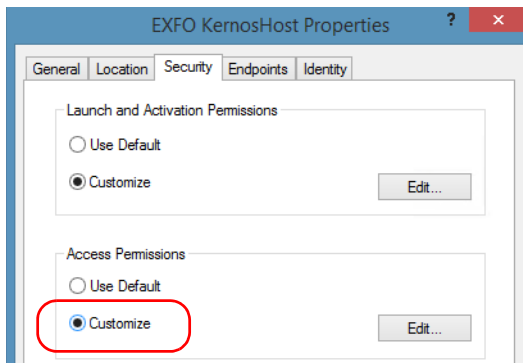

- 16.** In the **Access Permission** dialog box, tap **Add**.
- 17.** In the **Select Users or Groups** dialog box, under **Enter the object names to select**, type the name of the user to whom you want to give access permissions for remote access.

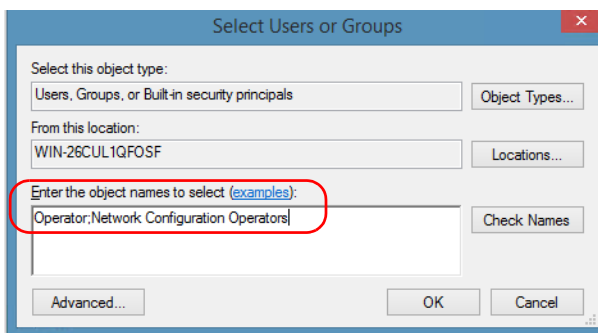

- 18.** Tap **OK**.
- 19.** In the **Access Permission** dialog box, select a user.

Preparing for Automation

Configuring DCOM Access to Your Unit

- 20.** To allow this user to access the unit remotely, select **Allow** for both permission choices.

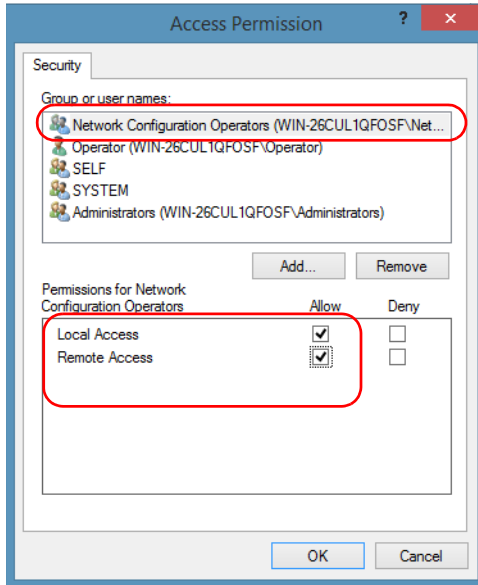

Note: You can also deny connection permission for specific users.

- 21.** Repeat steps 19 and 20 for each newly added user.
- 22.** Tap **OK** to close the **Access Permission** dialog box.
- 23.** Tap **OK** to close the **EXFO KernosHost Properties** dialog box.
- 24.** Restart your unit.

The EXFO ICSPIAccess Class component, located on your unit, can now be accessed with DCOM.

Enabling DCOM on Client Computer

Note: To run *DCOMCNFG.EXE*, you need Administrator access rights.

If you want to subscribe to EXFO IcSCPIAccess Class component events, you need to set security parameters on the client computer.

To enable DCOM on the client computer:

1. Start Windows, on the taskbar, click **Start** (Start button () under Windows 8.1 and Windows 10) and select **Run**.
2. In the **Open** box, type “DCOMCNFG.EXE” and tap **OK**.
3. In the **Component Services** dialog box, select: **Console Root > Component Services > Computers** to show available computers.

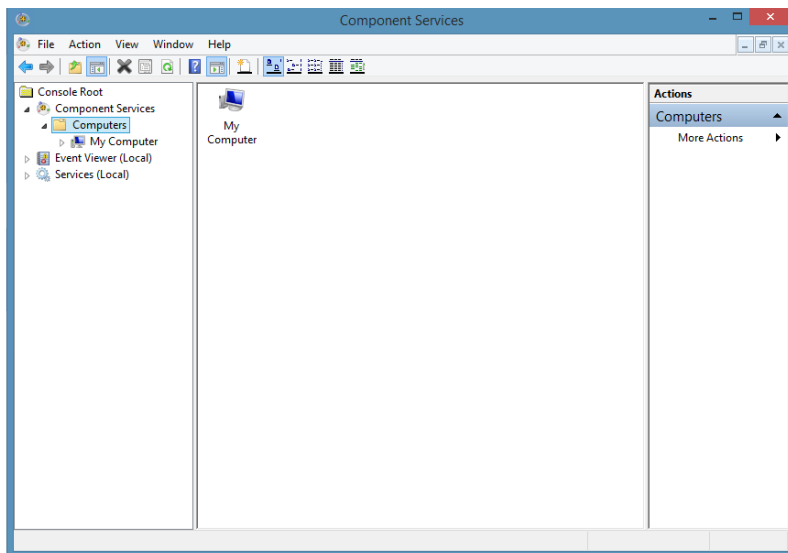

Preparing for Automation

Configuring DCOM Access to Your Unit

4. Right-click **My Computer**, and then select **Properties**.
5. In the **My Computer Properties** dialog box, tap the **Default Properties** tab.
6. Select **Enable Distributed COM on this computer**.

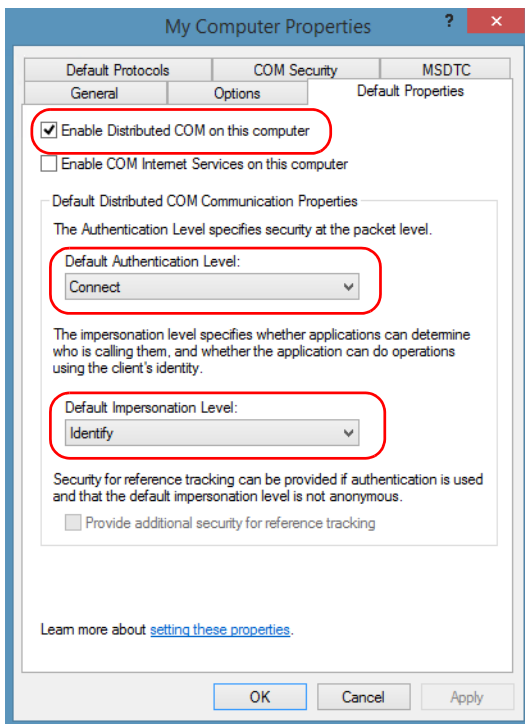

7. Under **Default Distributed COM Communication Properties**, in the **Default Authentication Level** list, select **Connect**.
8. In the **Default Impersonation Level** list, select **Identify**.
9. Tap **Apply**.

10. Tap the **COM Security** tab and, under **Access Permissions**, tap **Edit Limits**.

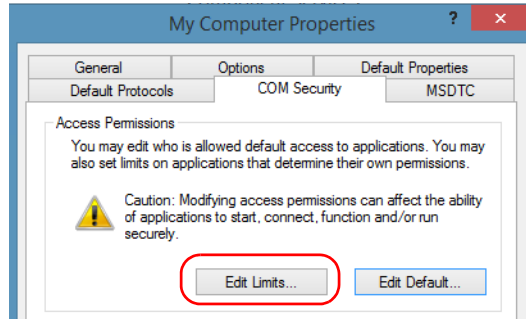

11. In the Access Permission dialog box, ensure that, for **ANONYMOUS LOGON**, local and remote accesses are allowed.
If **ANONYMOUS LOGON** is not listed under Group or user names, tap **Add** to add it.

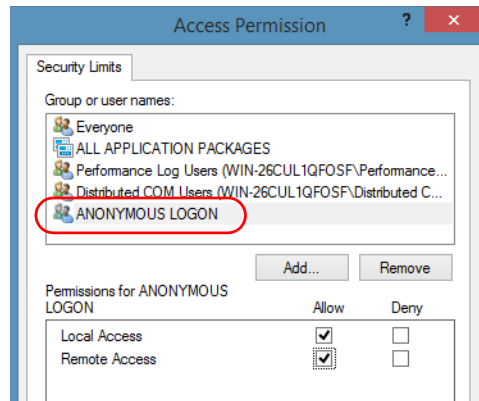

For more information on enabling events with DCOM, refer to *AppId Key* in MSDN Documentation.

Preparing for Automation

Configuring DCOM Access to Your Unit

Disabling DCOM Access to Your Unit

Note: To change the DCOM access to your unit, you need Administrator access rights.

If you no longer want client computers to access your unit using DCOM, you can disable this access.

To disable DCOM access to your unit:

1. From the main window, tap the **System Settings** button.
2. Tap **Control Panel**.
3. Tap **System and Security > Administrative Tools**.
4. Double-tap **Component Services**.
5. From the **Component Services** window, select: **Console Root > Component Services > Computers > My Computer > DCOM Config** to show the contents of the **DCOM Config** folder.

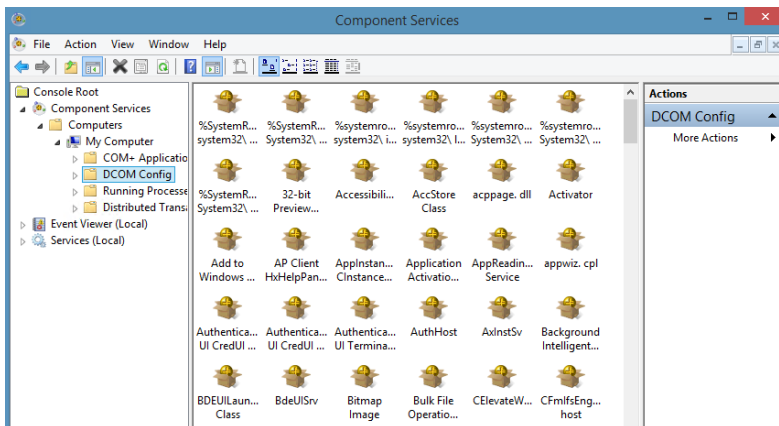

6. From **DCOM Config**, right-click **EXFO KernosHost**, and select **Properties**.

7. In the **EXFO KernosHost Properties** dialog box, tap the **Security** tab.
8. Under **Launch and Activation Permissions** and **Access Permissions**, select **Use Default**.

This ensures the EXFO IcSCPIAccess Class component uses the default lists instead of the customized lists.

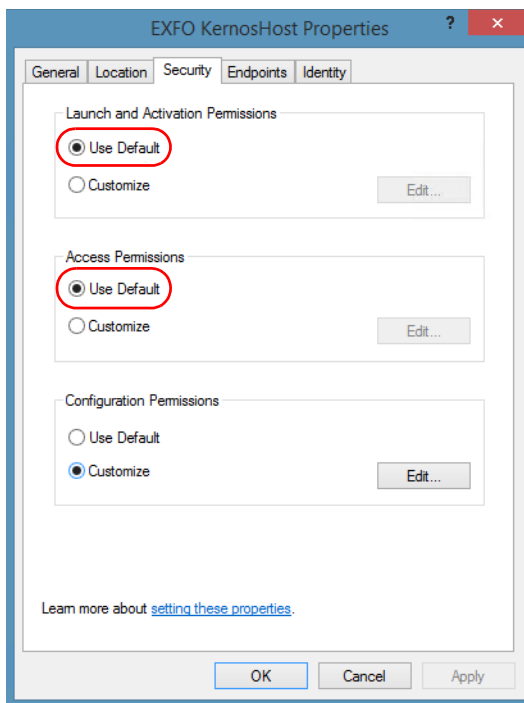

9. Tap **OK**.
10. Restart your unit.

The EXFO IcSCPIAccess Class component, located on your unit, *cannot* be accessed with DCOM.

Configuring Your Instruments

You can control the instruments in various ways such as writing your own scripts to send SCPI commands, or using dedicated applications provided by EXFO (when available).



IMPORTANT

Before being able to control instruments with SCPI commands, or control them remotely using a dedicated application such as EXFO Remote ToolBox, you must first allow remote access to these instruments.

Regardless of how you intend to control your instruments, you can configure the following parameters for each of them:

- Enable or disable remote access.
- Enable or disable the use as a standalone instrument. Setting an instrument as standalone allows to keep the instrument active even if all users close their dedicated applications.
- Enter a description to help you identify the instrument.
- Modify the logical instrument number (LINS) that the system assigns by default to each instrument for identification and access purposes.

If you are working with several units housing modules, you may also find useful to select a distinct offset value for each of these units. The offset value will be used when assigning the LINS, allowing you to identify a specific instrument more easily. For example, if the basic LINS is 1 and you have selected an offset of 10, you will be able to access the instrument at logical position 11 (offset + LINS).

Each LINS is associated with a specific instrument as long as this instrument remains in use in the system. When the instrument is removed, the LINS can then be assigned to another instrument.

Each user who wants to control the instrument from a computer using a dedicated application must install this application (for more information on the installation, refer to the application documentation).

- The instrument can be controlled both remotely and locally at the same time.
- You will have to configure remote control again in the following cases:
 - you inserted the module in another slot
 - you applied changes to applications while the module was not inserted in its slot.

Note: *Some instruments do not support remote control.*

Preparing for Automation

Configuring Your Instruments

To activate or deactivate remote control:

1. From the main window, tap the **System Settings** button.
2. Tap **Remote Control Configuration**.

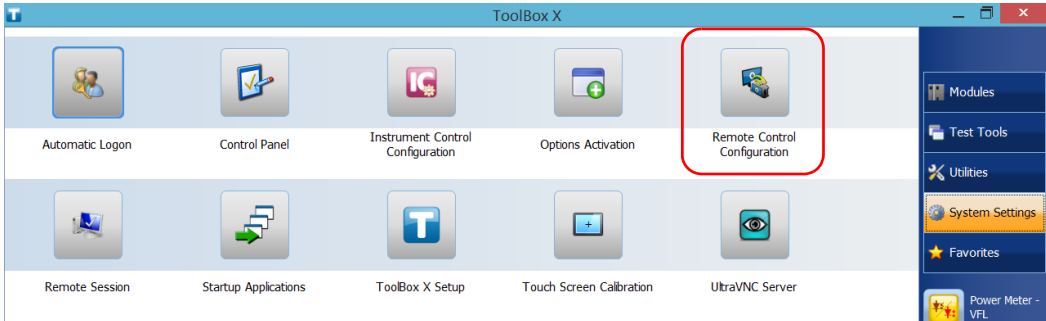

3. If necessary, tap **Change settings**, and then, when the application prompts you to authorize the changes to your unit, select **Yes**.

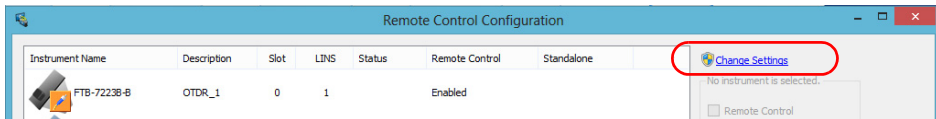

4. From the **Remote Control Configuration** window you will see all the instruments present in the system. Select the instrument for which you want to have a remote access.

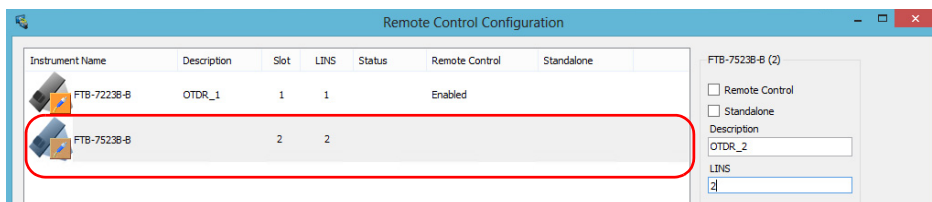

5. Set the parameters:

- Select **Remote control** to be able to access the instrument remotely (via TCP/IP over Telnet or other).
- Select **Standalone** to leave the instrument active even if all users close their dedicated applications.

Note: When a standalone instrument is no longer used, you can simply release it. See the corresponding procedure below to know how to proceed.

6. If desired, under **Description**, type a description that will help you identify the instrument.

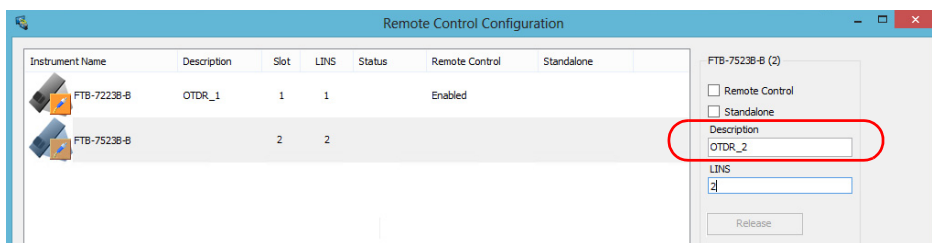

Note: You can enter up to 10 characters. The description can correspond to the test interface ID or to any other short text of your choice.

Preparing for Automation

Configuring Your Instruments

7. If necessary, under **LINS**, modify the logical instrument number that you will use to access the instrument remotely.

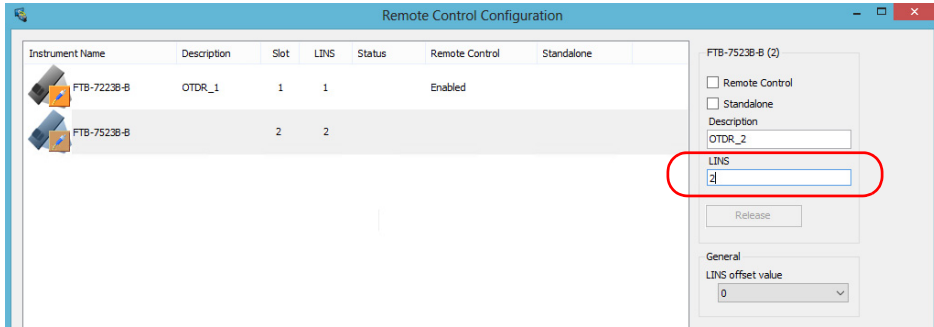

Note: If the **LINS** column is empty, it means that the corresponding instrument cannot be controlled using SCPI commands.

8. Tap **Apply** to confirm your changes or **OK** to apply your changes and close the window.

Note: This information will be updated the next time you start the instrument application and will appear in the title bar if the instrument application allows it. Refer to the corresponding instrument documentation for more details.

To define a **LINS** offset value:

1. From the main window, tap the **System Settings** button.
2. Tap **Remote Control Configuration**.

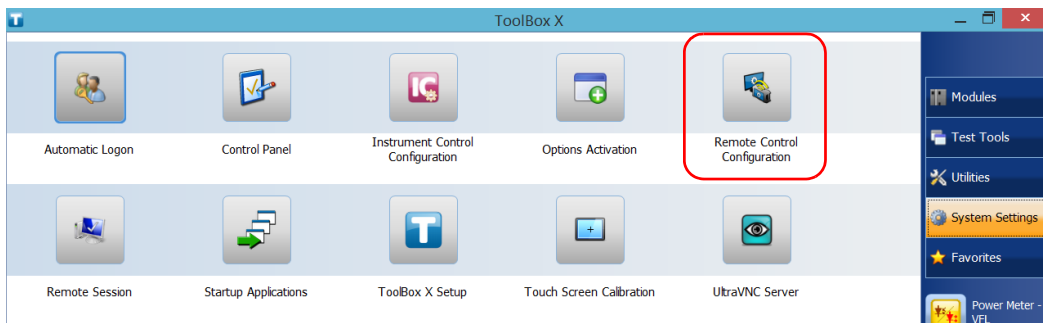

3. If necessary, tap **Change settings**, and then, when the application prompts you to authorize the changes to your unit, select **Yes**.

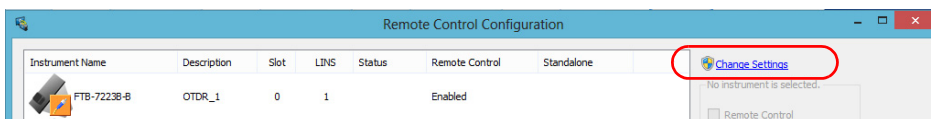

Preparing for Automation

Configuring Your Instruments

- From the **LINS offset value** list, select a value that will be used when assigning the LINS that will help you identify the instruments more easily if you are working with several units housing modules. If you prefer to access the instruments using the LINS as is, leave the offset value to 0.

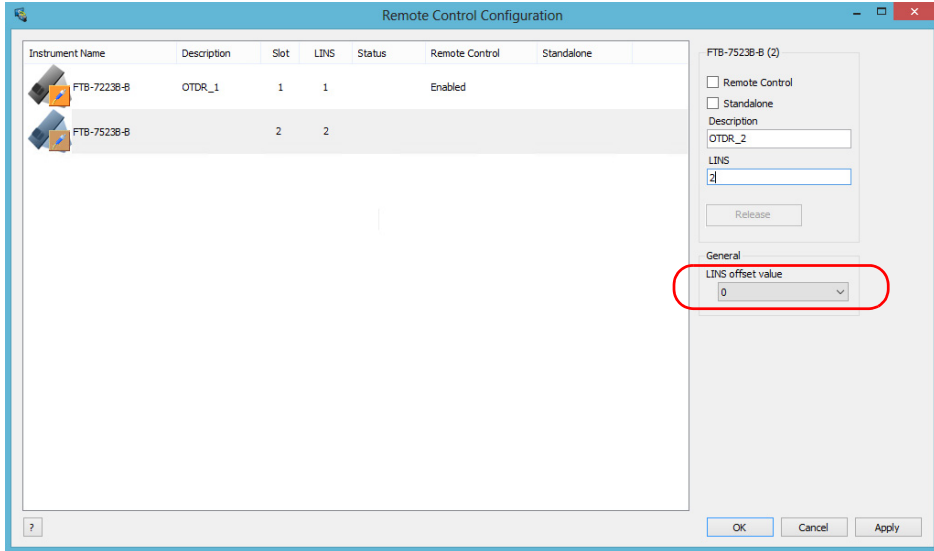

Note: The LINS offset value that you select applies only to the unit on which you configure the parameters.

Note: The LINS offset value that you select will be used to build the LINS of the next instruments that you will insert in the unit. The LINS of the instruments that were already in the system when you selected the LINS offset value will not be updated.

To release the remotely-controlled instrument:

Tap Release.

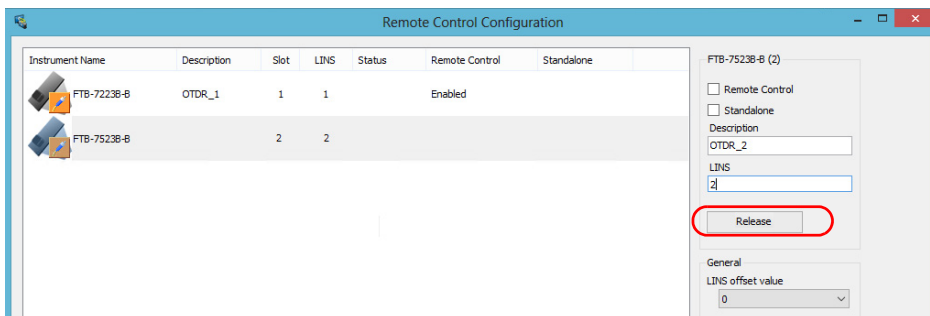

12 *Using Your Unit and Modules in an Automated Test Environment*

EXFO supplies commands that follow the guidelines determined by the SCPI consortium for all available instruments. EXFO also supplies COM properties and events allowing you to build your own application.

The present chapter gives you information to help you use the provided commands as well as COM properties and events to remotely control your instruments.

If you need information on how to prepare your unit for remote control, see the corresponding section in this documentation.

Note: *To have access to automation features on an FTB-2 unit, you must purchase the Automation option.*

Standard Status Data Structure

Each device that is physically connected to the remote bus has four status registers with a structure complying with the IEEE 488.2 standard. These registers allow the controller to monitor events and get useful information on the status of the devices it controls.

- Standard Event Status Register (ESR)
- Standard Event Status Enable Register (ESE)
- Status Byte Register (STB)
- Service Request Enable Register (SRE)

ESR and ESE

The standard event status register and status enable register information is presented in the following table.

Bits	Mnemonics	Bit Value
7	Power On (PON)	128
6	User Request (URQ)	64
5	Command Error (CME)	32
4	Execution Error (EXE)	16
3	Device-Dependent Error (DDE)	8
2	Query Error (QYE)	4
1	Not Used (N.U.)	0
0	Operation Complete (OPC)	1

Using Your Unit and Modules in an Automated Test Environment

Standard Status Data Structure

The following table presents a summary of the possible operations on ESR and ESE registers.

Register	Read	Write	Clear
ESR	Use *ESR?.	Impossible to write.	► Use *CLS. ► Read the register.
ESE	Use *ESE?.	Use *ESE.	Use *ESE with a value equal to 0.

STB and SRE

The status byte register and service request enable register information is presented in the following table.

Bits	Mnemonics	Bit Value
7	Not Used (N.U.)	0
6	Master Summary Status (MSS)/ Service Request (RQS)	64
5	Event Summary Bit (ESB)	32
4	Message Available (MAV)	16
3	Not Used (N.U.)	0
2	Error Available (EAV)	4
1	Not Used (N.U.)	0
0	Not Used (N.U.)	0

Using Your Unit and Modules in an Automated Test Environment

Standard Status Data Structure

The following table presents a summary of the possible operations on STB and SRE registers.

Register	Read	Write	Clear
STB	<ul style="list-style-type: none">▶ Use *STB?.▶ Use serial poll (GPIB bus sequence that allows retrieval of the value without interrupting the current process).	Impossible to write; the register content is only modified when the Event registers or Queues are modified.	Use *CLS before sending a query (to clear the Event registers and Queues and by the same token clear the STB register).
SRE	Use *SRE?.	Use *SRE with a value equal to 0 to disable the register or with a value equal to 1 to enable it.	<ul style="list-style-type: none">▶ Use *SRE with a value equal to 0.▶ At startup, the register is set to 0.

The diagram displayed on the next page is a useful aid in understanding the general commands and how a service request (SRQ) is generated.

Using a service request, a device notifies the controller that an event requiring special attention occurred. The controller will then find which device generated a SRQ (its RQS bit is set) and the causes of it.

Using Your Unit and Modules in an Automated Test Environment

Standard Status Data Structure

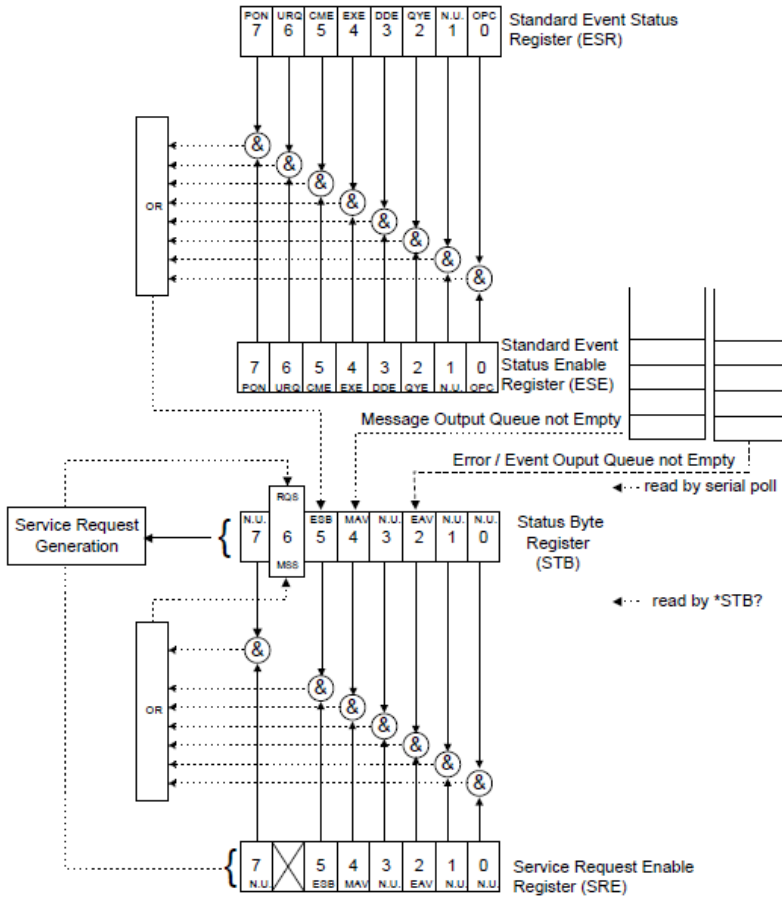

SCPI Command Structure

The information presented in this section provides an overview of SCPI programming. If you need detailed information, refer to:

- The International Institute of Electrical and Electronics Engineers. *IEEE Standard 488.2-1992, IEEE Standard Codes, Formats, Protocols and Common Commands For Use with ANSI/IEEE Std. 488.1-1987*. New York, 1992.
- *Standard Commands for Programmable Instruments (SCPI). Volume 1: Syntax and Style*. Vers. 1999.0 May, U.S.A, 1999.

The provided commands follow the guidelines determined by the Standard Commands for Programmable Instruments (SCPI) consortium. A *program message* consists of one or more commands (and/or queries) with their appropriate parameters.

For example, a program message could contain a command used to activate or deactivate a source. The corresponding command syntax would be:

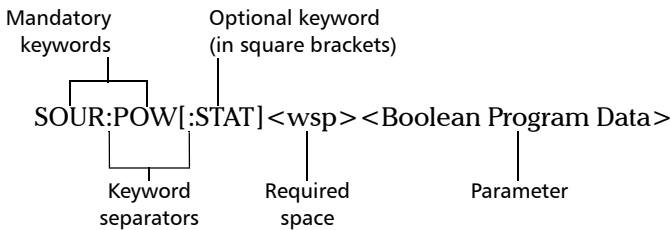

When sending a message containing the previous command, you would actually type: `SOUR:POW ON`.

The following table shows elements that are commonly used in the commands or queries syntax.

Item	Meaning
[]	Enclose optional keywords or parameters. <i>Do not include square brackets in your program message.</i>
[1..n]	Indicates that the instrument provides multiple capabilities and that you have to specify which one you want to use. If you omit the value, the command will take effect on the first capability. Multiple capabilities can be found at any branch of the command tree (root, intermediate node or terminal node). Example: If the command is :SENSe[1..n]:CORRection:COLLect:ZERO and you want it to take effect on the second SENSE (sensor) capability of the instrument, you may send this: :SENSe2:CORRection:COLLect:ZERO. <i>Do not include square brackets in your program message; simply enter the number.</i>
<wsp>	Indicates that a space is required (“wsp” stands for “white space”). Corresponds to ASCII character codes (0 to 9 and 11 to 32, in decimal). <i>Do not include “<wsp>” in your program message; simply type a space.</i>
<digit>	Element used in the construction of various numeric data types. Can take any value between 0 and 9 inclusively (corresponds to ASCII character codes 48 to 57, in decimal).

Using Your Unit and Modules in an Automated Test Environment

SCPI Command Structure

Item	Meaning
<mnemonic>	<p>Element used in the construction of certain data types and program messages.</p> <div data-bbox="444 354 982 574" data-label="Diagram"> </div> <p>In the diagram above,</p> <ul style="list-style-type: none"> ➤ “<Upper/lower case alpha>” corresponds to ASCII character codes (65 to 90 and 97 to 122, in decimal). ➤ “_” corresponds to an underscore character (code 95, in decimal).
< >	<p>Text appearing between angled brackets specifies the command parameter to be sent or the response you will receive from an instrument.</p> <p><i>Do not include angled brackets in your program message.</i></p>
	<p>Indicates that one, and only one, value must be selected from the available choices.</p> <p>Example: If the list is 0 1, you can only select 0 or 1.</p> <p><i>Do not include the pipe character in your program message.</i></p>
{ }	<p>Indicate that the enclosed parameters can appear 0 to n times when the command is used.</p> <p><i>Do not include braces in your program message.</i></p>
:	<p>Mandatory to separate keywords. Can be omitted at the beginning of a program message. For example, you can use either :SYST:ERR or SYST:ERR.</p>

Item	Meaning
;	<ul style="list-style-type: none"> ➤ Mandatory to separate the different commands of a program message when more than one command is sent at a time. In this case, it is called <i><PROGRAM MESSAGE UNIT SEPARATOR></i>. ➤ Also used to separate responses when multiple queries were sent in a single program message. In this case, it is called <i><RESPONSE MESSAGE UNIT SEPARATOR></i>.
,	<ul style="list-style-type: none"> ➤ Mandatory to separate parameters in a command or a query. In this case, it is called <i><PROGRAM DATA SEPARATOR></i>. ➤ Also used to separate the various responses from a query. In this case, it is called <i><RESPONSE DATA SEPARATOR></i>.

There are also several conventions regarding command syntax:

- Spelling errors will cancel the command or query.
- Commands and queries are not case-sensitive. You can type your program messages using either lower-case or upper-case letters.
- The command or query can be written using only the three- or four-letter shortcuts, only full words, or a combination of both.

The example below shows the long and the short forms of a same query.

:SYSTem:ERRor?	Long form
:SYST:ERR?	Short form (small words represented by the capital letters of the long form)
:syst:err?	

Consulting Data Types

If you need information about data types used in EXFO's documentation, see the appendix on data types.

Writing Remote Control Code

Your unit offers many commands permitting complete remote control of all the supported FTB components. These commands adhere to the SCPI standard.

You can find all the commands and queries supported by your unit in the *IEEE 488.2 and Specific Commands* appendix. For information on commands specific to particular instruments, refer to each instrument's user guide.

When you write code, you must follow these rules on message reception and transmission:

- The controller must have sent a complete message to the instrument (including the message terminator) before retrieving a response.
- The controller must retrieve all the responses from previous queries (including the response terminator) before sending a new message to an instrument.
- The controller must not try to retrieve a response from an instrument if the corresponding query has not been previously sent to the instrument.
- You must pay special attention to queries that return an indefinite ASCII response. To avoid any confusion, the IEEE 488.2 standard requires that this data type be immediately followed by a response termination character. For this reason, when working with compound queries, you must ensure that a query sending an indefinite ASCII response is the last query of the series.
- Be careful when sending program messages containing multiple queries that return large amounts of data. Since the controller can only retrieve data when the instrument has finished processing the queries, it could result in problems ranging from a saturation of the output queue to the complete blocking of the whole system.

Error Message Format

System and device-specific errors are managed by your unit. The generic format for error messages is illustrated in the following figure.

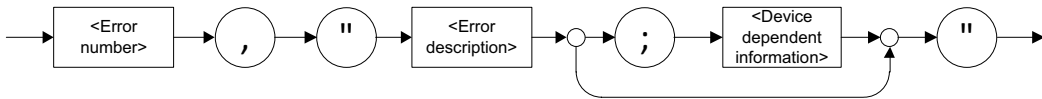

As shown in the above figure, the message contains three parts:

- error number
- error description
- device-dependent information

Error messages ending in a negative number are SCPI-based errors.

For a complete list of possible errors, see the appendix on SCPI-based errors.

Monitoring Remote Commands

ToolBox X allows you to monitor remote commands sent to your units, if desired.

To monitor remote commands:

1. From the main window, tap the **Test Tools** button.
2. Depending on which type of communication protocol you are using, select **IC Monitor** or **SCPI Telnet Monitor**.

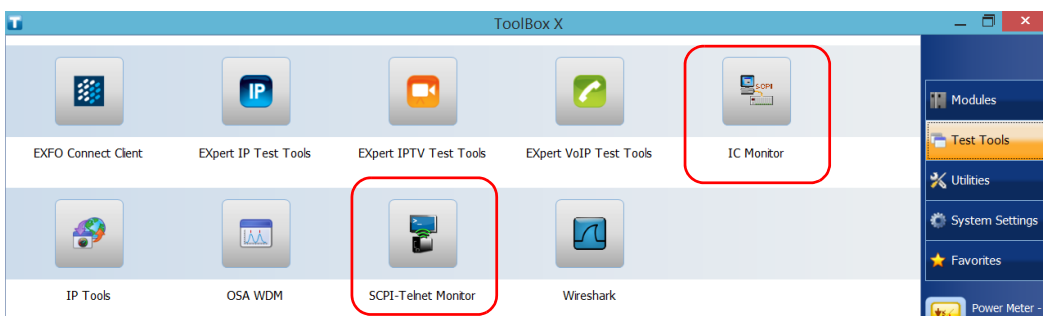

Using Your Unit and Modules in an Automated Test Environment

Monitoring Remote Commands

3. Do one of the following:

- ▶ If monitoring using ActiveX or RS-232, tap **Connect**.

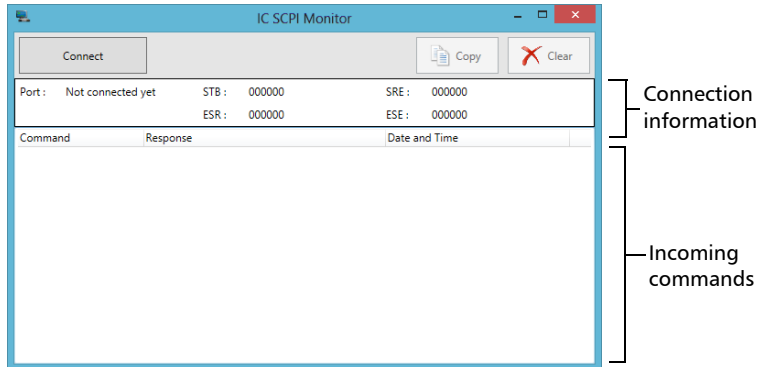

You are automatically connected to the monitoring system, and the **Connect** button changes to a **Disconnect** button, enabling you to disconnect from IC when you have finished your work.

Once connected, your current connection information will appear in the upper part of the window, and the commands will appear as a list in the lower part of the window.

To clear the history, tap **Clear**.

To view the list in any word processor, tap **Copy** to send it to the clipboard, and then paste it in your document. You can use any program, as the list is copied in text format.

To exit the monitoring utility, tap .

For more information, see the section on using your unit in an automated test environment.

Using Your Unit and Modules in an Automated Test Environment

Monitoring Remote Commands

- If monitoring using TCP/IP, which provides sending SCPI commands over TCP/IP through Telnet or Socket from the EXFO Instrument Control, you are automatically connected to the monitoring system.

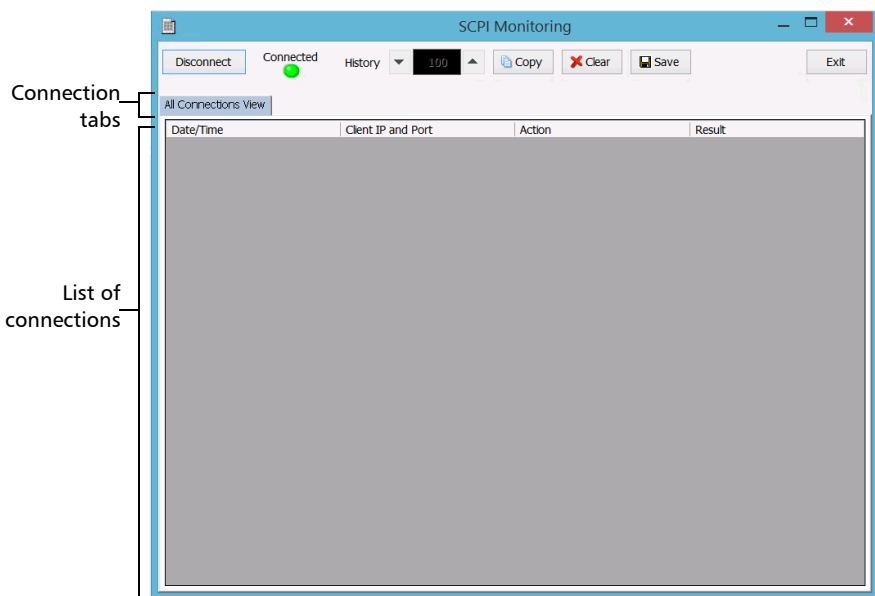

Once connected, your current connection information will appear in the **All Connections View** tab, and the commands will appear as a list in the lower part of the window.

The **Disconnect** button becomes available for you to tap when you are ready to disconnect.

Connection information is also displayed in a separate tab, identified by its IP address, from where you can monitor the commands and other actions sent through TCP/IP over Telnet, as well as the results.

Using Your Unit and Modules in an Automated Test Environment

Monitoring Remote Commands

With the **History** parameter, you determine how many commands you want to keep in the list. You can increase or decrease the number by using the arrow buttons on each side of the list.

To clear the history, tap **Clear**.

To view the list in any word processor, tap **Copy** to copy it to the clipboard, and then paste it in your document. You can use any program, as the list is copied in text format.

To save the list as a file, tap **Save**.

To exit the monitoring utility, tap **Exit**.

For more information, refer to the user documentation about communication through TCP/IP over Telnet.

13 *Maintenance*

To help ensure long, trouble-free operation:

- Always inspect fiber-optic connectors before using them and clean them if necessary.
- Keep the unit free of dust.
- Clean the unit casing and front panel with a cloth slightly dampened with water.
- Store unit at room temperature in a clean and dry area. Keep the unit out of direct sunlight.
- Avoid high humidity or significant temperature fluctuations.
- Avoid unnecessary shocks and vibrations.
- If any liquids are spilled on or into the unit, turn off the power immediately, disconnect from any external power source, remove the batteries and let the unit dry completely.



WARNING

The use of controls, adjustments and procedures, namely for operation and maintenance, other than those specified herein may result in hazardous radiation exposure or impair the protection provided by this unit.

Cleaning Detector Ports

Regular cleaning of detectors will help maintain measurement accuracy.



IMPORTANT

Always cover detectors with protective caps when unit is not in use.

To clean detector ports:

1. Remove the protective cap and adapter (FOA) from the detector.
2. If the detector is dusty, blow dry with compressed air.
3. Being careful not to touch the soft end of the swab, moisten a cleaning tip with *only one drop* of optical-grade liquid cleaner.



IMPORTANT

Some cleaners may leave traces if used abundantly. Do not use bottles that distribute too much liquid at a time.

4. While applying light pressure (to avoid breaking the detector window), gently rotate the cleaning tip on the detector window.
5. Repeat step 4 with a dry cleaning tip or blow dry with compressed air.
6. Discard the cleaning tips after one use.

Cleaning VFL-Type Connectors

VFL-type connectors are fixed on your unit and can be cleaned using a mechanical cleaner.



WARNING

Verifying the surface of the connector with a fiber-optic microscope WHILE THE UNIT IS ACTIVE WILL result in permanent eye damage.

To clean a connector using a mechanical cleaner:

1. Insert the cleaning tip into the optical adapter, and push the outer shell into the cleaner.

Note: *The cleaner makes a clicking sound to indicate that the cleaning is done.*

2. Verify connector surface with a fiber inspection probe (for example, EXFO's FIP).

Maintenance

Cleaning the Touchscreen

Cleaning the Touchscreen

Clean the touchscreen with a soft, non-abrasive cloth, such as one used for cleaning reading glasses, dampened with water.



CAUTION

Using anything else than water can damage the special coating used for units equipped with an outdoor-enhanced screen (S2 option).

When not using your unit, EXFO recommends using the screen protector that came with it.

Recharging the Batteries

Your unit uses smart lithium-ion (Li-Ion) batteries. The number of batteries that can power your unit and that come with it depends on the model that you have purchased (see *Power Sources* on page 17).

- The charge status is shown in the taskbar (at the left of the clock). Simply tap the battery icon for more information.
- The unit also indicates the charge status with the LED on its front panel (see *LED Indicators Description* on page 13).



CAUTION

- Use only the certified power cord that is suitably rated for the country where the unit is used.
- For the FTB-2 and FTB-2 Pro units: Only charge the batteries with the AC adapter/charger provided by EXFO with your unit.



IMPORTANT

- ▶ Batteries are not charged at the factory. You must fully charge them before using the unit for the first time. The batteries are fully charged after a few hours or when the battery LED indicator stops flashing.
- ▶ The time required to charge batteries depends on various factors such as the type of modules currently in use and the ambient temperature.
- ▶ To ensure that batteries function or charge properly, keep them in temperatures between 0 °C and 40 °C (32 °F and 104 °F). Store them between -20 °C to 60 °C (-4 °F to 140 °F).
- ▶ Do not leave a battery discharged for several days.
- ▶ Depending on the way the unit is used, after a while, the charge status icon may no longer correspond to the actual power level of the battery (for example, the icon indicates that the power level is sufficient, but the unit turns off because the battery is too weak).
- ▶ After 300 cycles (approximately 18 months of use), you may want to replace the batteries with new ones to maintain optimal operation conditions. Otherwise, the operating time might be reduced.



IMPORTANT

- Remove the batteries if the unit will not be used for more than two weeks. For more information on how to remove the battery, see *Replacing Batteries* on page 303.
- If you need to store the batteries for an extended period of time, place them in a cool dry place, and ensure that they are charged at around 80 % of their capacity. Every three months during the storage period, verify the battery level. Recharge the batteries when necessary, so that their charge level remains around 80 % of the total capacity. This will ensure that you get the optimum performance out of the batteries.

To recharge the batteries:

- For the FTB-2 and FTB-2 Pro units: Connect the unit to a power outlet using the AC adapter/charger.
- For the FTB-4 Pro units: Connect the unit to a power outlet with the standard three-wire power cord.

The charge cycle will start and end automatically.

Maintenance

Modifying the Low-Battery Thresholds

Modifying the Low-Battery Thresholds

Your unit was set at the factory to warn you about low battery charge level (when it reaches about 10 %), and to shut down automatically when the battery reaches a very low charge level (less than 5 %).

However, you can modify these thresholds to better suit your needs.

Note: *Each power plan has its own set of thresholds. This means that when you modify the thresholds of a given power plan, the thresholds of the other power plans are not changed automatically. If you want to modify the thresholds of other power plans, you have to select them in turn and make the required changes.*

To modify the low-battery thresholds:

1. From the main window, tap the **System Settings** button.
2. Tap **Control Panel**.

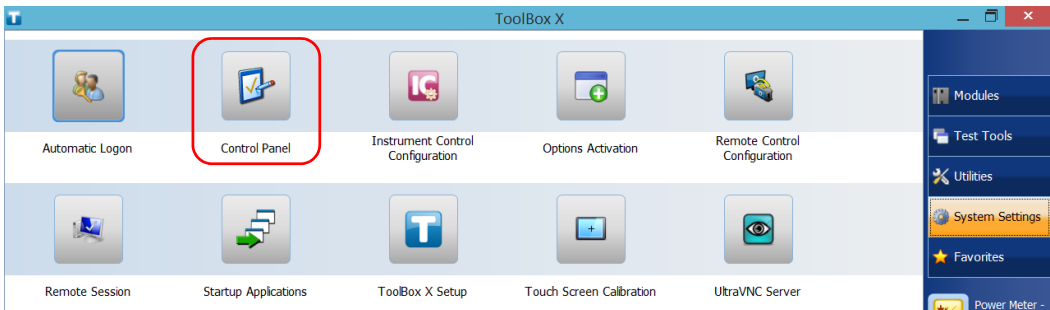

3. Tap **Hardware and Sound > Power Options**.

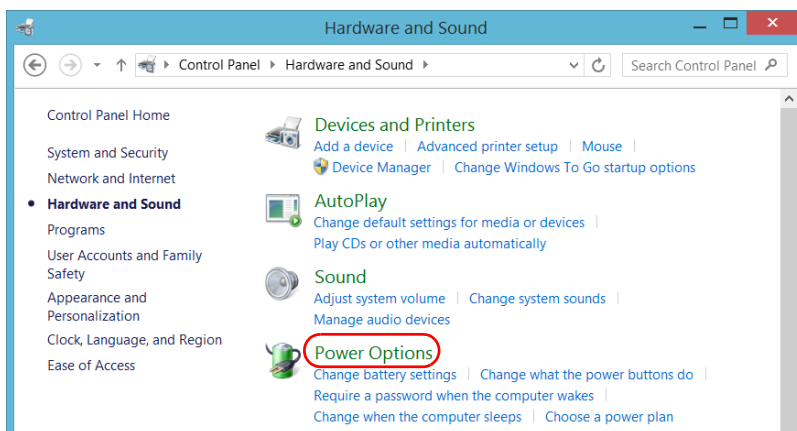

4. From the list of available power plans, locate the set of parameters that you want to modify.

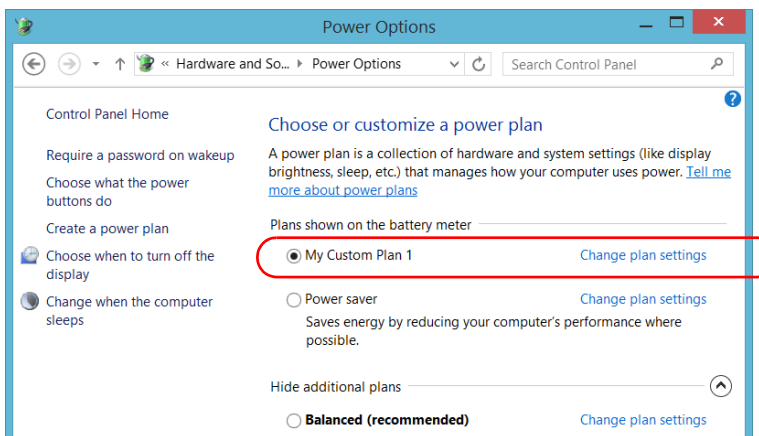

5. Tap **Change plan settings** (appearing next to the power plan).

Maintenance

Modifying the Low-Battery Thresholds

6. If necessary, tap **Change settings that are currently unavailable**.

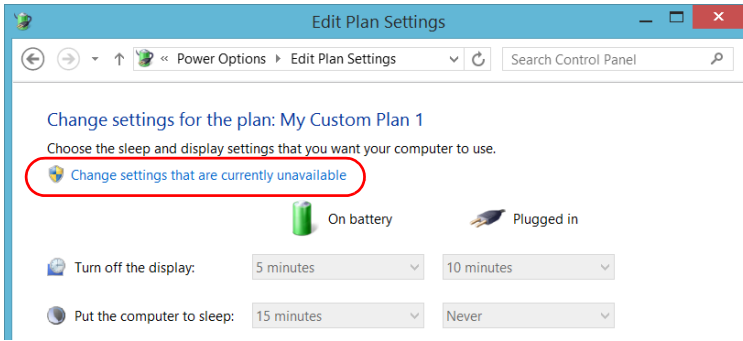

7. Tap **Change advanced power settings**.

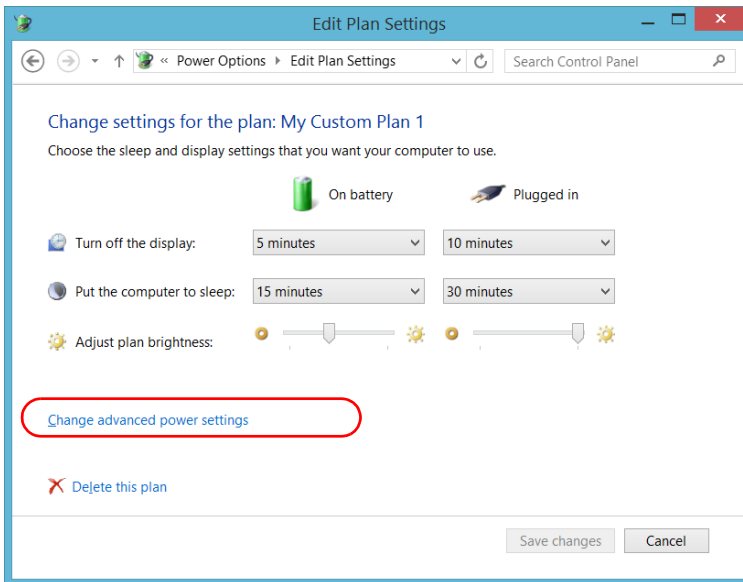

- From the list of settings, go to **Battery** > **Critical battery level**.

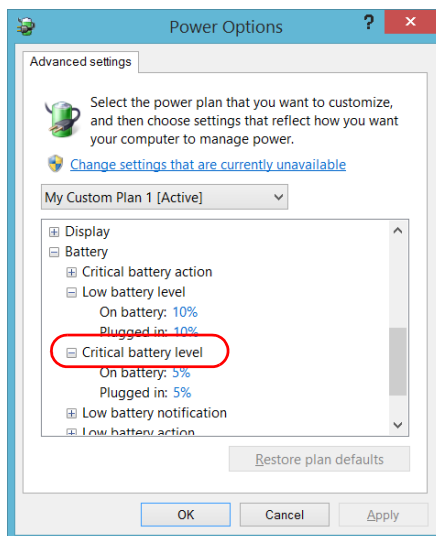

- Under **On battery**, enter the new value.

Maintenance

Modifying the Low-Battery Thresholds

10. From the list of settings, go to **Battery** > **Low battery level**.

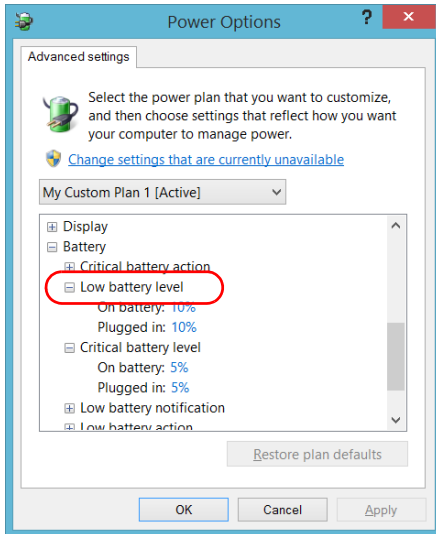

11. Under **On battery**, enter the new value.

12. Tap **OK**.

13. Close the window.

The changes are taken into account immediately.

Replacing Batteries

Your unit can be powered either by batteries or from an appropriate power outlet when used with the provided AC adapter/charger (FTB-2 and FTB-2 Pro), or with the provided three-wire power cord (FTB-4 Pro).

You can easily replace the batteries while the unit is running, as long as the unit remains powered by another reliable power source during the operation.

For more information on the available power sources for your unit, as well as their characteristics, refer to the unit's technical specifications.

Before you go out in the field, make sure you install batteries in the unit unless you have an adequate and reliable power source.

Maintenance

Replacing Batteries



WARNING

Your unit uses smart lithium-ion (Li-Ion) batteries with built-in protection that have been especially designed for EXFO. For this reason, you can only replace them with batteries of the same type and model.



WARNING

RISK OF EXPLOSION IF BATTERY IS REPLACED BY AN INCORRECT TYPE. DISPOSE OF USED BATTERIES ACCORDING TO THE MANUFACTURER'S INSTRUCTIONS.



WARNING

Do not throw batteries into fire or water and do not short-circuit the battery electrical contacts. Do not disassemble.



IMPORTANT

Recycle or dispose of used batteries properly, in accordance with local regulations. Do not dispose of them in ordinary garbage receptacles. For more information, see the section about recycling and disposal in this user documentation.

To replace the batteries in the unit:

- 1.** Open the battery compartment as follows:
 - 1a.** Position the unit so that its front panel rests on a flat surface such as a table.
 - 1b.** Lift the unit's support to have a complete access to the battery compartment.
 - 1c.** Lift the mobile part of the battery compartment screws and turn the screws counterclockwise until the compartment door is loose. Since they are captive screws, you cannot remove them completely.

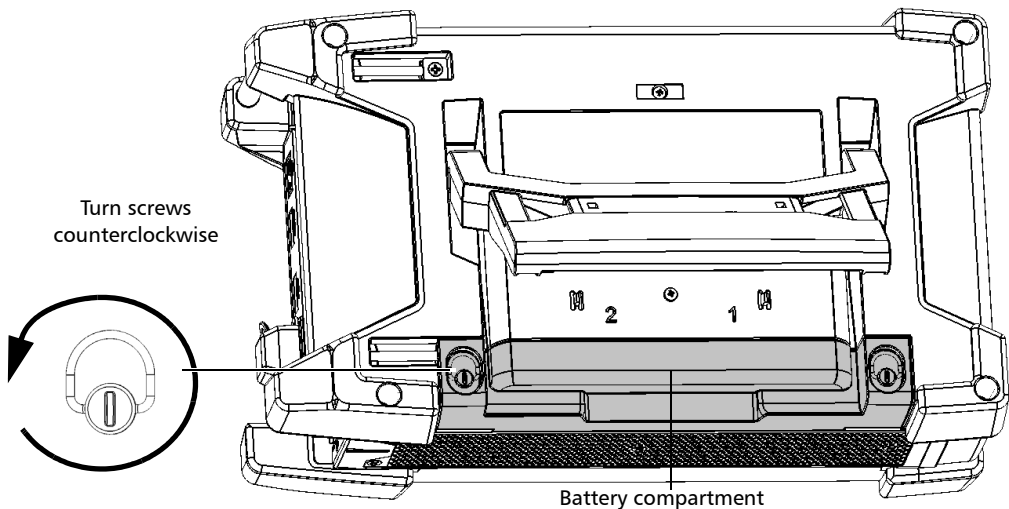

- 1d.** Remove the battery compartment door.

Maintenance

Replacing Batteries

2. Use the markings on the back panel to locate the battery that you want to replace, and then pull on the battery's tab to free it from its socket.

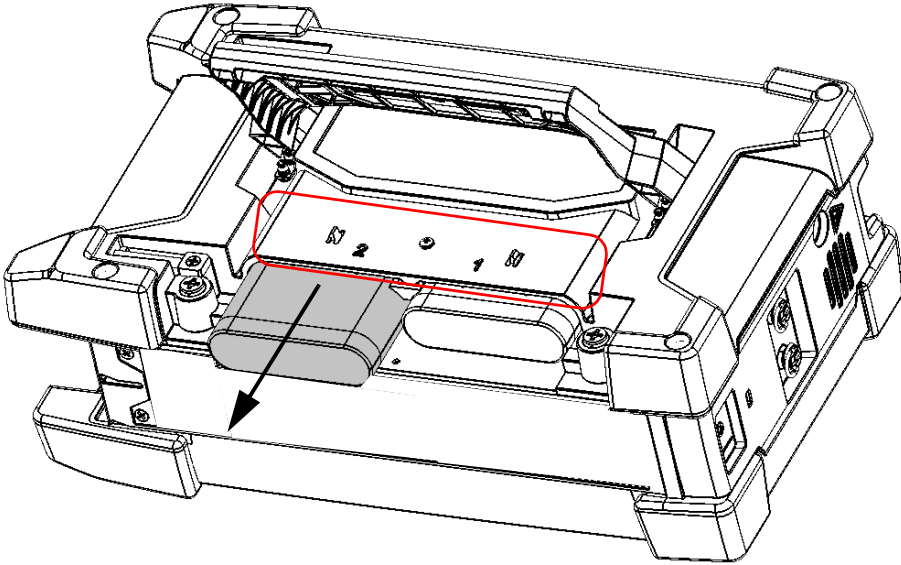

IMPORTANT

On the FTB-2 units, the second battery slot does not power the unit. The battery must be inserted in the first battery slot (as indicated on the label affixed to your unit).

- 3.** Install the new battery as follows:
 - 3a.** Place the battery so that its poles are facing down and that they point towards the back of the battery socket.

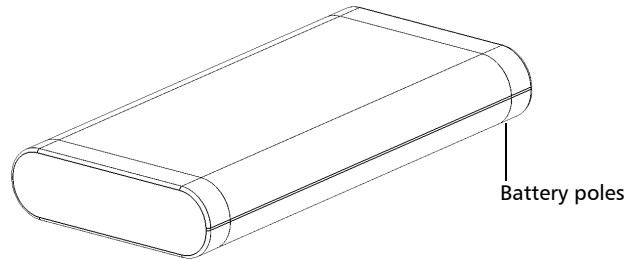

- 3b.** Slide in the new battery, and push it toward the back until it stops.

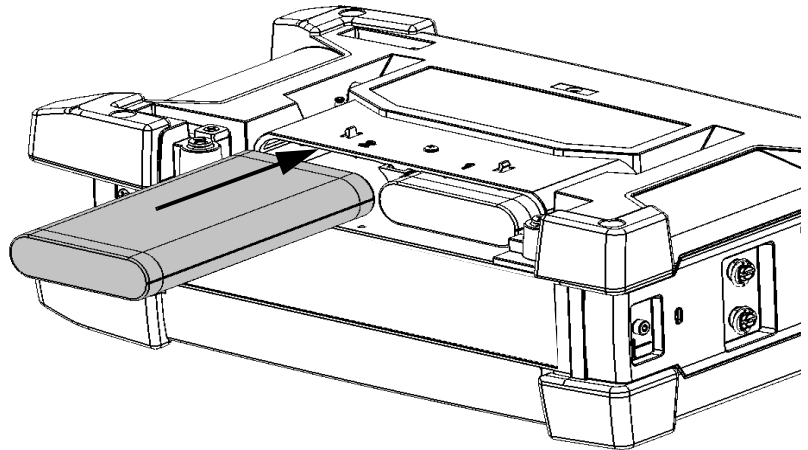

- 4.** Repeat steps 2 and 3 with the other battery if it also needs replacement (FTB-2 Pro and FTB-4 Pro only).
 - 5.** Position the battery compartment door so that you can see its two screws.

Maintenance

Replacing Batteries

6. Place the battery compartment on the unit, making sure that the sides of the compartment are flush with the back of the unit. If necessary, slightly move the battery compartment door until alignment is correct.

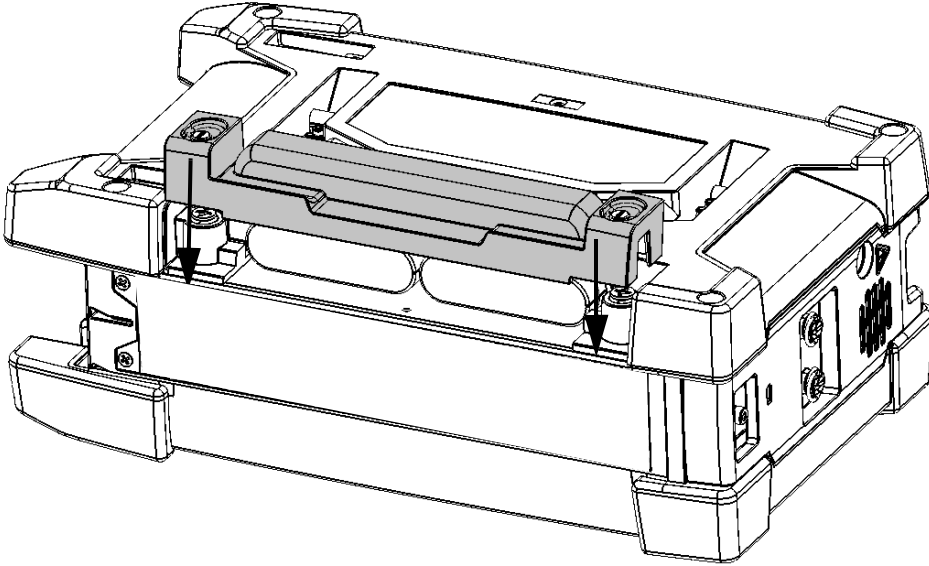

7. Lift the mobile part of the compartment screws and, while applying slight pressure, turn the screws clockwise until they are tightened.

Installing or Removing the Power Meter and VFL

If your unit was not equipped with a power meter and a VFL at time of your initial purchase, you can purchase one afterwards and install it yourself.

You may also need to remove the power meter to send it to an authorized service center for recalibration.

Note: *If you prefer not to remove the power meter from your unit when a calibration is needed, you can also send the complete unit to the service center.*



WARNING

- To avoid serious injuries as well as irreparable damages both to your unit and your power meter, **ALWAYS TURN OFF YOUR UNIT** (shutdown mode, not sleep), **DISCONNECT IT FROM THE EXTERNAL POWER SOURCE**, and **REMOVE ALL BATTERIES**. For more information on the ways to turn off your unit, see *Turning Off Your Unit* on page 57.
- Be careful not to drop metal objects such as screws inside the unit. These could cause a short-circuit leading to a fire or an explosion.

Maintenance

Installing or Removing the Power Meter and VFL



CAUTION

Electrostatic discharge (ESD) damage can cause complete or intermittent equipment failures.

- Always use an ESD-preventive wrist or ankle strap when handling the power meter. Ensure that the antistatic strap makes good skin contact and that the end of its wire is grounded properly.
- Always handle the power meter by the edges of its metal faceplate (where the detector port is located).
- Never touch the circuit board.
- Keep any piece of clothing away from the power meter during the handling.
- Never touch any component inside the unit either with tools or your fingers.
- Only place the power meter on antistatic surfaces such as an antistatic mat, and quickly put power meters that need recalibration into antistatic bags.



CAUTION

Use only power meters and VFL designed for your unit and approved by EXFO.

To install a power meter:

1. Turn off your unit.
2. Disconnect the unit from its external power source and remove the batteries.
3. Put on a wrist (or an ankle) antistatic strap and ensure that the end of its wire is grounded properly.

4. Place the unit vertically so that its right panel is facing you, and then locate the protective cover that hides the power meter bay.

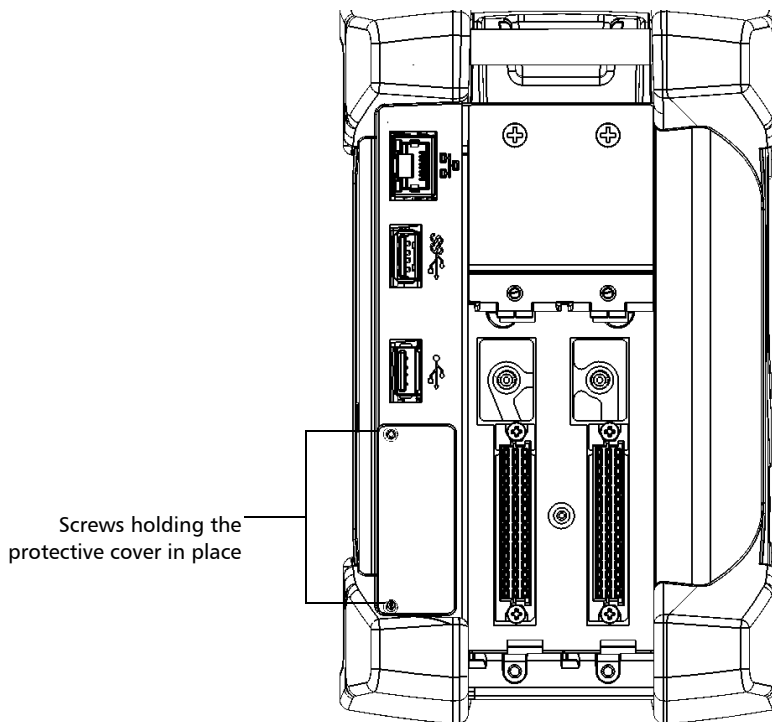

5. Using a screwdriver, remove the two screws of the protective cover.

Note: *Keep the screws close at hand because you will need them to secure the power meter in place later.*

6. Remove the protective cover.



IMPORTANT

Do not discard the protective cover. You will need it to protect the power meter bay if you ever send the power meter for recalibration.

Maintenance

Installing or Removing the Power Meter and VFL

7. By holding the power meter by its faceplate, position it so that the writings are right-side up.

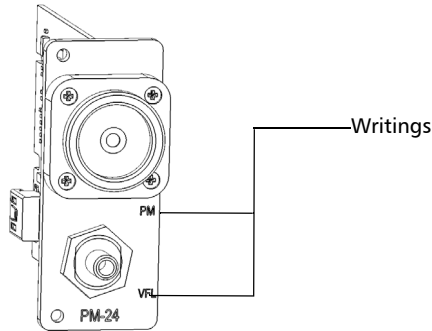

8. Carefully align the power meter with the corresponding bay.

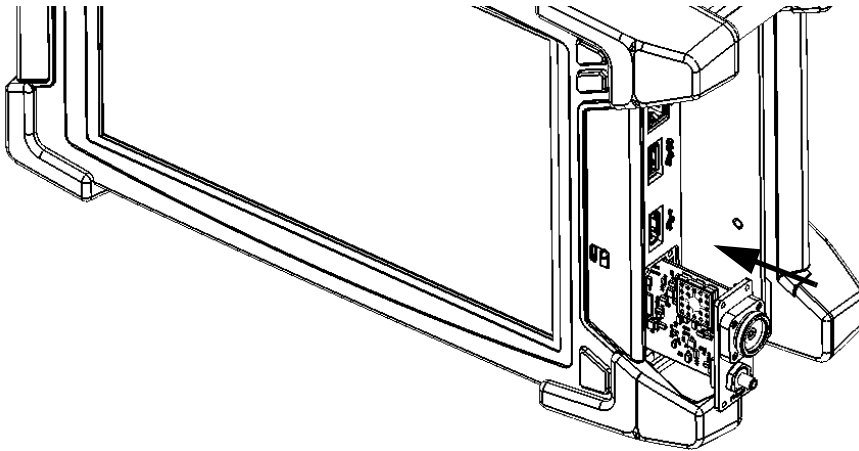

9. Gently slide the power meter into the bay until its faceplate is flush with the edge of the bay. As the power meter reaches the back of the bay, you should feel a slight resistance, indicating that it is properly connected inside the unit.

Note: *If the power meter slides all the way into the bay without any resistance, it probably means that it is not properly inserted.*

- 10.** Using a screwdriver, secure the power meter in place with the screws that you have removed at step 5.
- 11.** Remove your antistatic strap.
- 12.** Connect your unit to an external power source if desired.
- 13.** If it is not already done, turn on your unit.
- 14.** Start the power meter application to ensure that the instrument is working properly.

Note: *If the power meter is not detected, this could mean that it is not inserted properly in the unit. In this case, repeat the installation procedure. If the problem persists, contact EXFO.*

Maintenance

Installing or Removing the Power Meter and VFL

To remove the power meter for recalibration:

1. Turn off your unit.
2. Disconnect the unit from its external power source and remove the batteries.
3. Put on a wrist (or an ankle) antistatic strap and ensure that the end of its wire is grounded properly.
4. Place the unit vertically so that its right panel is facing you, and then locate the power meter.
5. Using a screwdriver, remove the two screws of the power meter.

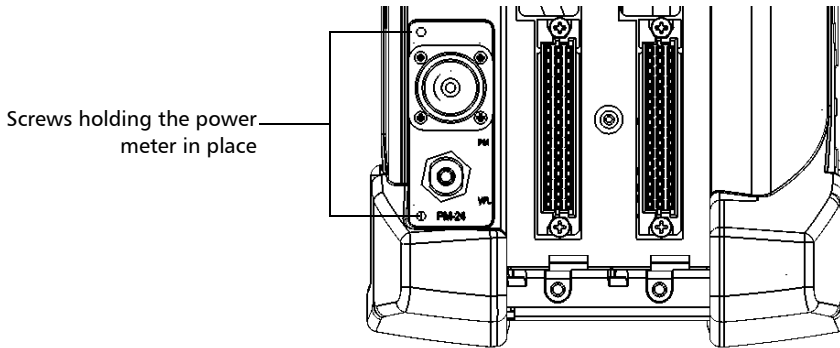

Note: *If you have a protective cover for the power meter bay, keep the screws close at hand. You will need them to secure the protective cover in place later.*



IMPORTANT

Do not discard the screws. You will need them to secure the protective cover, and the power meter in its bay when it is back from calibration.

6. By holding the power meter by its faceplate, gently pull it out of the bay completely.

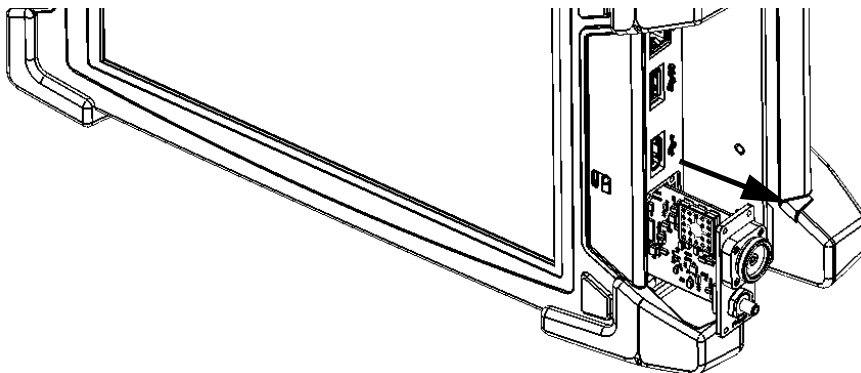

7. Place the power meter in an antistatic bag.
8. If you have a protective cover, proceed as follows:
 - 8a. Carefully place the cover over the power meter bay.
 - 8b. Using a screwdriver, secure the protective cover in place with the screws that you have removed at step 5.
9. Remove your antistatic strap.
10. Connect your unit to an external power source if desired.

Managing Windows Updates

The parameters that are available to configure the updates depend on the operating system that your unit is running.

In all cases, only the applications from Microsoft will be updated with the automatic Windows update feature. If you want to update EXFO applications, see *Installing or Upgrading the Applications* on page 71. The third-party applications will need to be updated manually.

Windows 10

By default, your unit is configured to check for updates, but to let you choose whether you want to download and install them or not.

If you prefer, you can manually check for updates.

You can also pause the updates for a maximum of 35 days, after which they will be automatically installed. Refer to Microsoft documentation for more information.

To manually check for updates:

1. From the task bar, tap the **Start** button (), and then **Settings** ().
2. Tap **Update & security**.

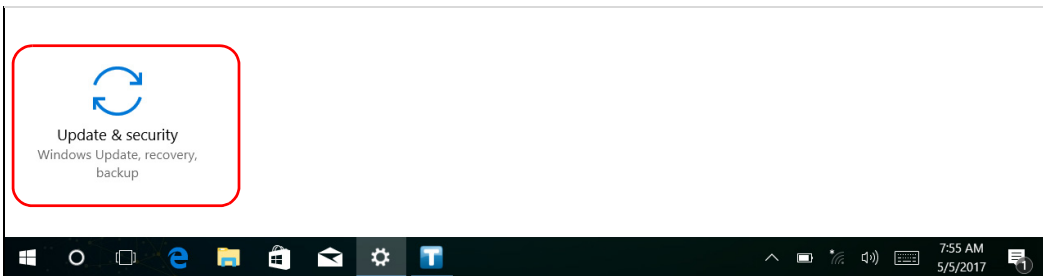

3. Select Windows Update.

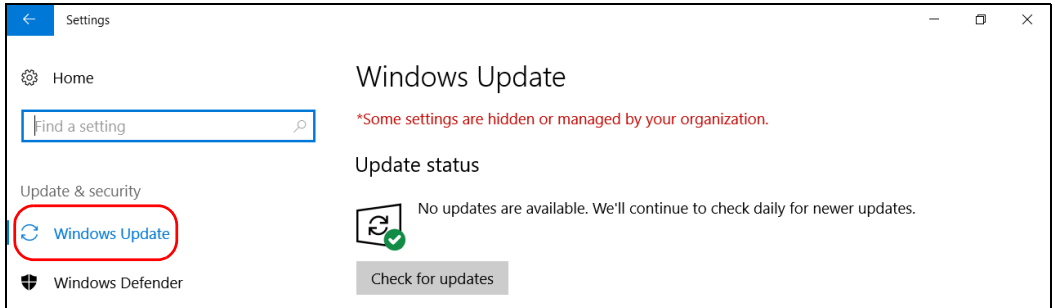

4. Under Update status, tap Check for updates.

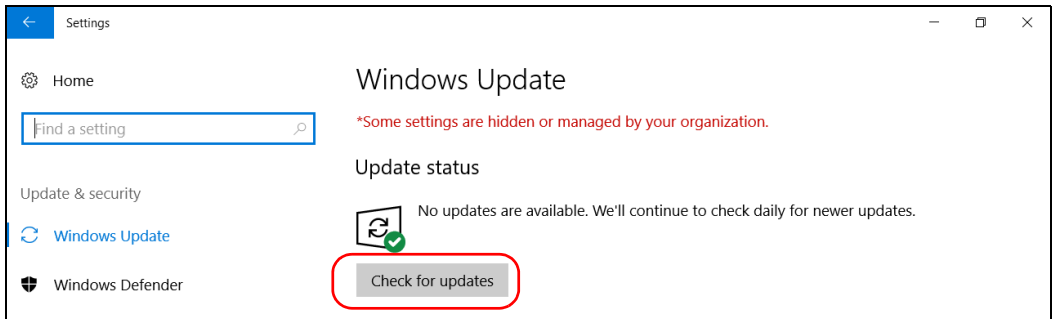

5. Follow the on-screen instructions.

Maintenance

Managing Windows Updates

Windows Embedded 8 Standard and Windows 8.1 Pro

By default, your unit is configured to check for updates, but to let you choose whether you want to download and install them or not.

However, if you prefer, you can configure your unit to automatically search and install Windows updates to ensure that you benefit from the latest versions of the Windows applications. Your unit will need an Internet access for the updates.

To manage the updates for Windows applications:

1. From the main window, tap the **System Settings** button.
2. Tap **Control Panel**.

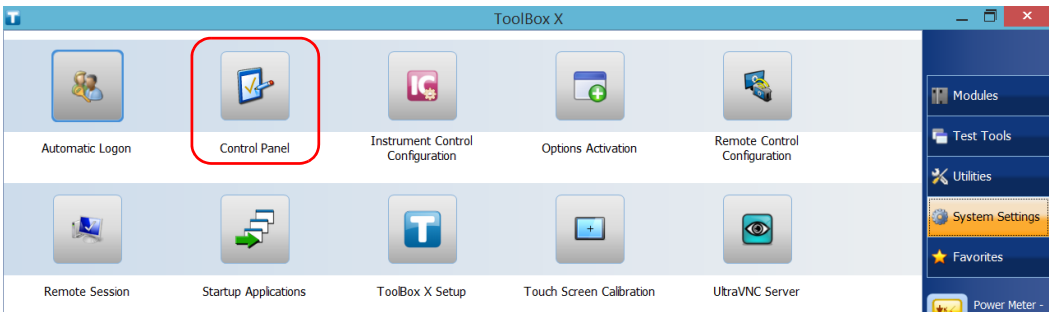

3. Tap System and Security.

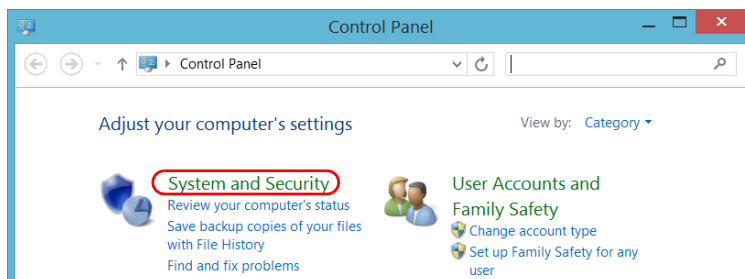

4. Under Windows Update, tap Turn automatic updating on or off.

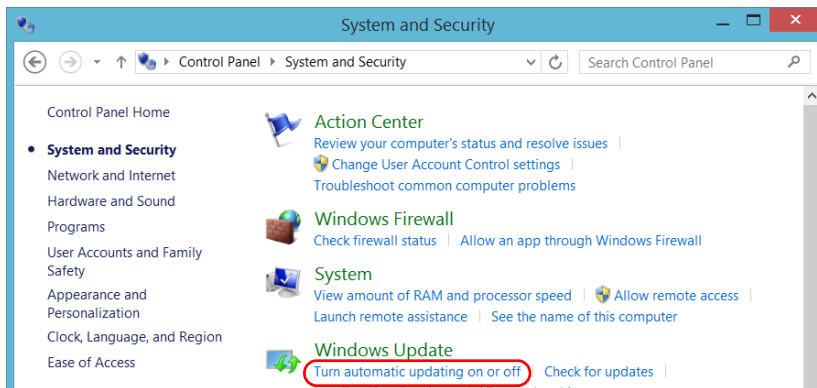

Maintenance

Managing Windows Updates

5. Select the update options that best suit your needs.

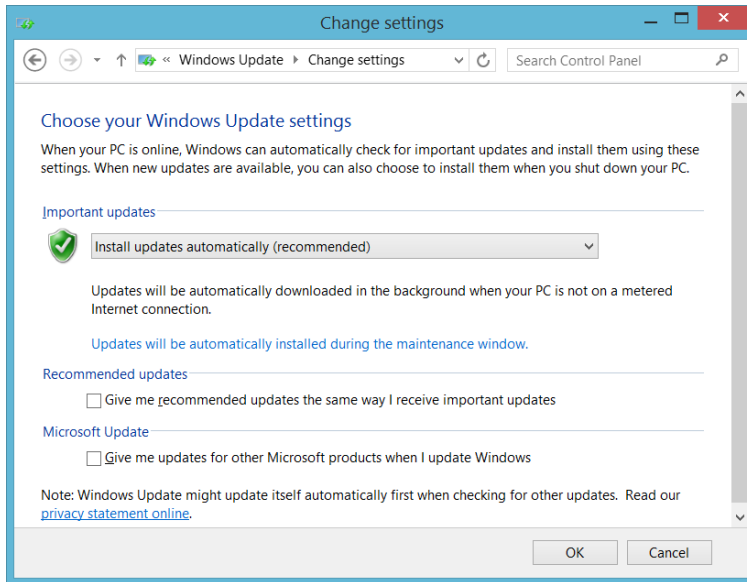

6. Tap **OK** to confirm your changes and return to Control Panel.

Replacing Fuses (FTB-4 Pro Only)

The unit contains two F6.3A L type fuses (5 mm x 20 mm (0.197 in x 0.787 in), fast-acting, low-breaking capacity, 250 V). The fuse holder is located on the left panel of the unit, just below the power inlet.



WARNING

Both neutral and live wires are energized. If a fuse is blown, make sure that no part of the unit remain energized when changing it.

To replace a fuse:

- 1.** Turn off the unit and unplug the power cord.
- 2.** Using a flat-head screwdriver as a lever, pull the fuse holder out of the unit.

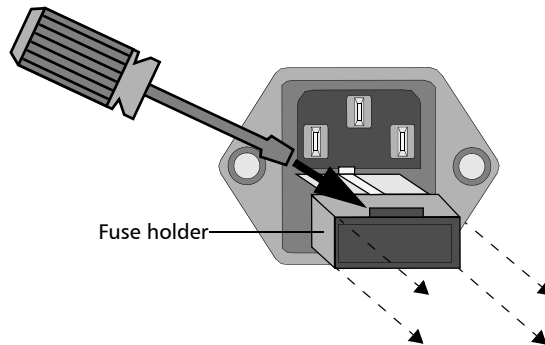

Maintenance

Recycling and Disposal

3. Check and replace the fuses, if necessary.
4. Insert the new fuse into the fuse holder.

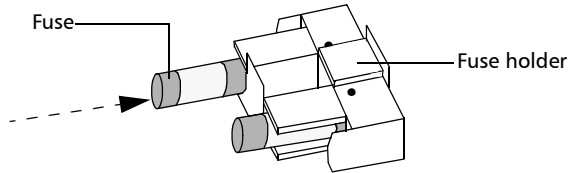

5. Make sure the fuses are placed firmly in the holder prior to reinsertion.
6. Firmly push the fuse holder into place.

Recycling and Disposal

For complete recycling/disposal information, visit the EXFO Web site at www.exfo.com/recycle.

14 Troubleshooting

Solving Common Problems

Before calling EXFO's technical support, you may want to consider the following solutions to problems that could occur.

Problem	Possible Cause	Solution
My unit does not start.	It is not connected to a power source.	Make sure that the external power supply is connected at both ends.
	Batteries are completely discharged.	Change or recharge the batteries.
	The system has encountered a problem.	Press the On/Off button for at least fifteen seconds to force a hardware reset on the unit.
	Windows startup files have been corrupted.	Contact EXFO.
	The ambient temperature is below 5 °C (41 °F).	Please wait for the unit to warm up. It could take up to 10 seconds before the power LED () is lit.

Troubleshooting

Solving Common Problems

Problem	Possible Cause	Solution
My unit is running slower than expected.	The configuration of some of the Windows components is underway in the background.	<p>The first few times that you start your unit, after a reset operation, or after certain updates, you may notice that the performance of your unit is not optimum.</p> <p>If this is the case, you may want to leave your unit idle for about an hour to give Windows the time to complete its configuration tasks.</p>
My unit is not responding.	The system has encountered a problem.	Press the On/Off button for at least fifteen seconds to force a hardware reset on the unit.
The screen does not keep its calibration. OR The screen is hard to calibrate properly.	The screen was calibrated using the tool provided with Windows instead of the tool provided with ToolBox X.	<ul style="list-style-type: none">➤ From the Control Panel, go to Hardware and Sound > Tablet PC Settings.➤ Tap Reset.➤ If you need to perform further adjustments to the calibration, from ToolBox X, tap System Settings > Touch Screen Calibration.

Problem	Possible Cause	Solution
The USB device I have just connected is not working.	The device has not been detected.	Disconnect, then reconnect the device. Turn off the unit, then turn it on again.
	You do not have the proper driver for this device.	Ensure that you have the right driver (can be provided with the device itself, or obtained from the Internet).
The unit does not recognize a test module.	Module application is not installed.	Install the corresponding application using the Update Manager application.
	Defective module.	If the unit recognizes other modules, the faulty module could be defective. Return it to EXFO for repairs.
	Module is not supported on your unit.	Refer to the unit's technical specifications for the complete list of supported modules.
The module application does not start when I tap the corresponding icon.	The unit is powered by batteries, and the module currently in use requires more energy than the batteries can provide.	Connect your unit to an external power source.
	Module is not supported on your unit.	Refer to the unit's technical specifications for the complete list of supported modules.

Troubleshooting

Solving Common Problems

Problem	Possible Cause	Solution
The mobile broadband USB modem key is connected, but I am not able to access the Internet.	There is no SIM card in the USB modem key.	Insert the SIM card into the USB modem key. For complete instructions, refer to the documentation that came with your modem key.
	The USB modem key is not detected properly.	Disconnect the modem key from your unit, and try connecting it again. If the modem key is still not detected, try connecting it to another USB port.
	The SIM card has not been activated or there is a problem with service package that you purchased. There is a problem with the mobile network.	Contact your provider of mobile services.

Problem	Possible Cause	Solution
Even though my unit is equipped with the RF (Wi-Fi) option, no GPS coordinates are available in the GPS Coordinates Viewer utility.	The SMARTGPS option is not activated on the unit.	Activate the option (see <i>Activating Software Options</i> on page 74).
	The EXFO Link application is not running on the smart device.	Start the EXFO Link application on the smart device. If EXFO Link is not installed on the smart device, see <i>Getting Ready to Retrieve Geolocation Information</i> on page 137.
	No mobile wireless hotspot has been created on the smart device yet.	Create a mobile hotspot to which the unit can connect. For more information, refer to the user documentation that came with your smart device.
	The unit is not connected to the mobile hotspot of the smart device.	Ensure that the hotspot has been configured properly, and then connect your unit to the mobile hotspot as you would do with any wireless network (see <i>Connecting to a Wireless Network</i> on page 178).

Troubleshooting

Solving Common Problems

Problem	Possible Cause	Solution
The GPS coordinates are not accurate.	The settings in the EXFO Link application are not set properly.	Start the EXFO Link application on the smart device, and modify the geolocation settings. For more information on how to modify the settings related to geolocation, refer to the EXFO Link user documentation.
	The reception of the GPS signal is poor, possibly because the unit and smart device are currently used indoors.	<ul style="list-style-type: none">➤ Try to use the unit and smart device outdoors and as far away as possible from buildings and other solid objects to see if you can get more accurate coordinates.➤ Wait a few minutes before retrieving the coordinates again.
	No data plan has been activated on the smart device.	In certain cases, such as when there is no GPS signal, a data plan can help you retrieve coordinates. It can be also useful when you need to retrieve more accurate coordinates and in a shorter amount of time. Contact your mobile service provider for more information on how to subscribe to a data plan and activate it.

Problem	Possible Cause	Solution
Batteries are not recharging.	Ambient temperature is too high or too low.	Make sure that the temperature in the location where you recharge the batteries is within the specifications
	The AC adapter or the power cord is not connected properly.	<ul style="list-style-type: none">➤ For FTB-2 and FTB-2 Pro units: Make sure that the AC adapter is connected to the unit and that the AC power cord is connected to both the adapter and the AC outlet.➤ For FTB-4 units: Make sure that the power cord is connected properly to the unit and to the AC outlet.

Troubleshooting

Solving Common Problems

Problem	Possible Cause	Solution
<p>When the unit is connected to an external power source, the battery LED () is red (steady).</p>	<p>One or more batteries may have been stored for an extended period of time.</p>	<ul style="list-style-type: none"> ➤ Turn off the unit (shut down). ➤ Disconnect the unit from its external power source, and remove all the batteries. ➤ Put the batteries back in place, and reconnect the unit to its external power source. ➤ Restart the unit. <p>The unit will try to detect and reactivate the batteries, but they probably will have partially lost their ability to hold a charge.</p> <p>If the LED remains red even after performing the steps above, there is a problem with the batteries. Contact EXFO.</p>
<p>An error message warns me that there is not enough disk space to perform a refresh operation on my unit.</p>	<ul style="list-style-type: none"> ➤ When you perform a refresh operation, Windows creates a folder (<i>Windows.old</i>) in which the files from the previous installation are stored. This folder now uses too much disk space. ➤ The disk needs a cleanup. 	<p>Remove the <i>Windows.old</i> folder or the unused files with the Disk Cleanup utility. For more information, see <i>Freeing Up Disk Space with the Disk Cleanup Utility</i> on page 187.</p>

Problem	Possible Cause	Solution
<p>The Windows interfaces switch partially or do not switch at all to the selected language.</p>	<p>In Windows 10, when you select a language that you have installed manually, the Windows interfaces may remain in the language configured at time of purchase because some of the components need to be updated first.</p>	<ul style="list-style-type: none"> ➤ From the taskbar, tap the  icon. ➤ Locate the application that did not switch to the current language. You can search for the “Windows” keyword if you prefer to view only the Windows applications. ➤ From the selected application’s page, tap Update. Follow the on-screen instructions.
	<p>In Windows Embedded 8 Standard, when you select a language that you have installed manually, the Windows interfaces remain in the language configured at time of purchase. However, the EXFO applications are displayed in the selected language (when available).</p>	<p>Contact EXFO if you think that the language that was configured at time of purchase does not cover your needs.</p>

Troubleshooting

Restoring Your Unit to Normal Operation

Problem	Possible Cause	Solution
I am experiencing communication problems between the VPN client and the VPN server.	The date on your unit may not be properly configured.	Ensure that the date set on your unit corresponds to the current date.
I have performed a recovery operation on my unit and I no longer see my EXFO applications.	The unit is running Windows 10 and the recovery operation was performed using the recovery tools from Microsoft instead of the wizard provided by EXFO.	Reset your unit to its factory settings. For more information, see the corresponding procedure in <i>Restoring Your Unit to Normal Operation</i> on page 332.

Restoring Your Unit to Normal Operation

If you ever encounter major problems with your unit (for example, the unit does not behave the way it used to), you can revert it to a previous state. You can revert your unit either to its initial state (as it was at time of purchase), or to a specific state with a backup image (WIM file) created previously.

Note: For current updates, use *Update Manager*.

You can create your own WIM files directly from your unit and store them on a USB key for future use.



IMPORTANT

The WIM files that you create are based on the serial number of your unit. This means that the WIM files created on one unit are only valid to restore this particular unit.



IMPORTANT

The creation of a WIM file implies a compression of the files that are currently installed on your unit. The size of the files after compression cannot be estimated beforehand.

For this reason, the application **WILL NOT PROMPT YOU AT THE BEGINNING** of the operation if the storage capacity (or the file system) of your USB key is not appropriate.



CAUTION

- Before starting one of the recovery operations, connect your unit to a power outlet using the provided AC adapter/charger or power cord.
- **DO NOT TURN OFF** your unit while the recovery operation is underway. Doing so may severely damage your unit. Damaged units will need to be sent back to EXFO for repair.

The recovery operations that are offered for your unit depend on the operating system that it is running.

Troubleshooting

Restoring Your Unit to Normal Operation

Windows 10

When you want to restore your unit, there are several options. The table below gives an overview of the possibilities.

Method	Description
Restore	<ul style="list-style-type: none">➤ The unit will be reverted to the state in which it was when the WIM file was created.➤ All data files will be lost once the operation is complete.➤ If you have installed products and updates since the WIM file was created, you will have to reinstall them.
Reset to factory settings	<ul style="list-style-type: none">➤ The unit will be reverted to its initial state.➤ All data files will be lost once the operation is complete.➤ If you have installed products and updates since you purchased your unit, you will have to reinstall them.



IMPORTANT

To avoid problems, always use the wizard provided by EXFO to revert your unit to a previous state, not the recovery tools provided by Microsoft.





IMPORTANT

The size of the WIM will depend on the disk space that is currently used on your unit.

To avoid problems, always use a USB key with an NTFS file system, and a minimum of 16 GB of free disk space.

To create a WIM file for your unit:

1. From the task bar, tap the **Start** button () , and then **Settings** ().
2. Tap **Update & security**.

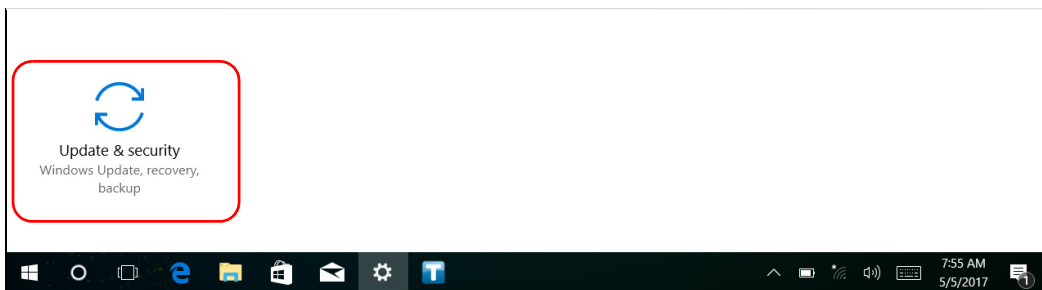

Troubleshooting

Restoring Your Unit to Normal Operation

3. Select **Recovery**.

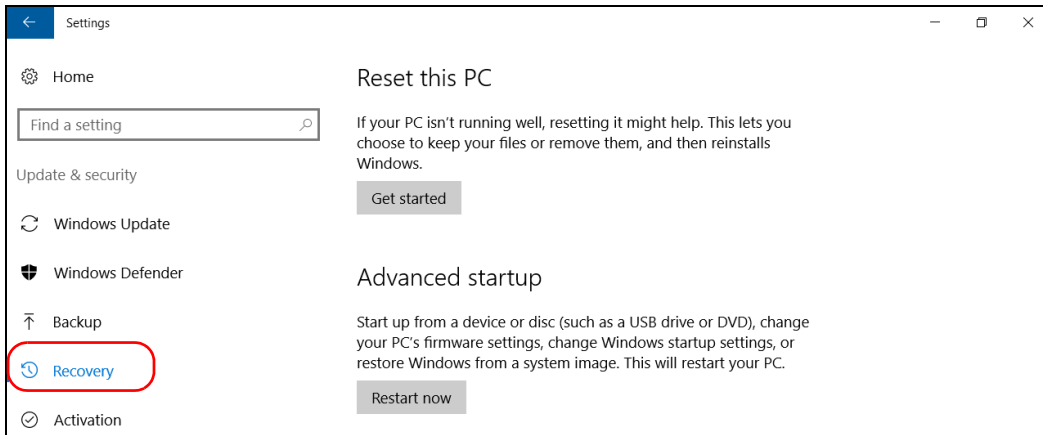

4. Under **Advanced Startup**, tap **Restart now**.

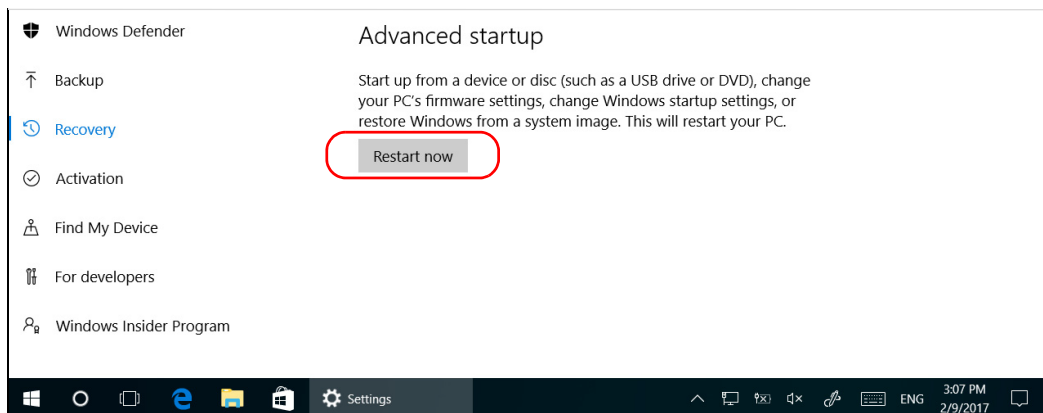

5. Under **Choose an option**, tap **Troubleshoot**.

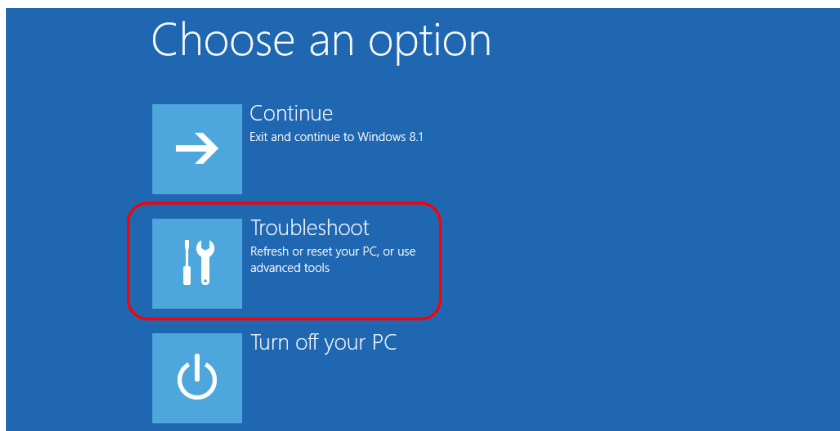

6. Tap **Platform Imaging Utility** to display the corresponding application.

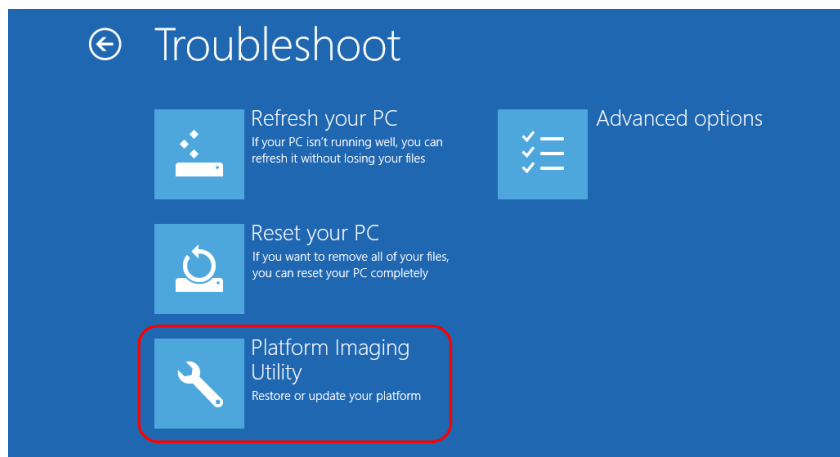

7. Connect a USB key to your unit.

Troubleshooting

Restoring Your Unit to Normal Operation

- From the Platform Servicing and Imaging Utility wizard, select **Create a WIM file**, and then tap **Next**.

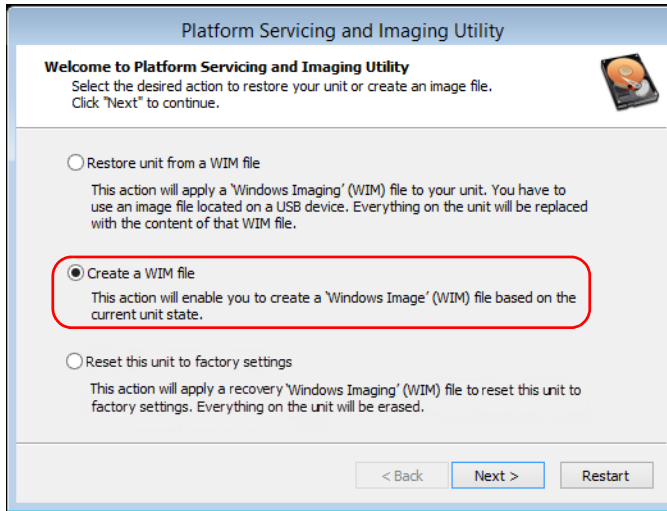

- Tap **Browse**.

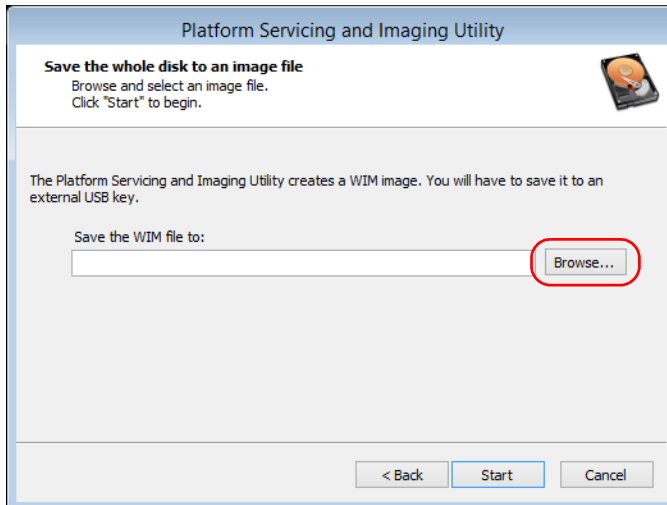

- 10.** Locate the USB key, and then double-tap its identifier to access the contents.
- 11.** Select the desired folder.
- 12.** Enter a file name, and then tap **Save**.
- 13.** Tap **Start**.

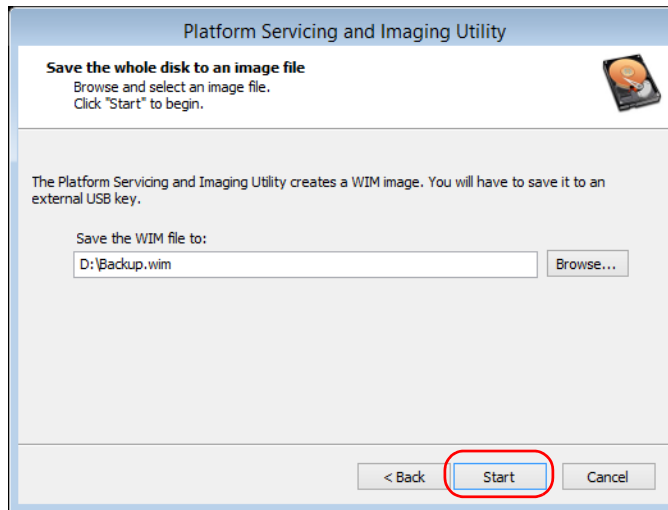

Note: *The time required to create the image varies with the configuration of your unit.*

- 14.** When the operation is complete and the application prompts you, tap **OK**.
- 15.** Disconnect the USB key.

Troubleshooting

Restoring Your Unit to Normal Operation

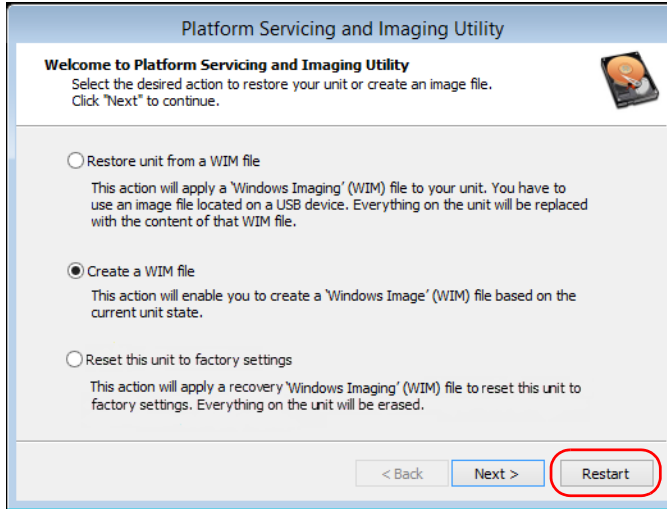

16. Tap **Cancel** to return to the Welcome window of the utility.

17. Tap **Restart**.



The WIM file is ready for future use.

To revert your unit to a previous state with a WIM file:

1. Ensure that your unit will remain powered on during the operation by connecting it to a power outlet using the provided AC adapter/charger or power cord.
2. If desired, back up your data.
3. From the task bar, tap the **Start** button (), and then **Settings** ().
4. Tap **Update & security**.

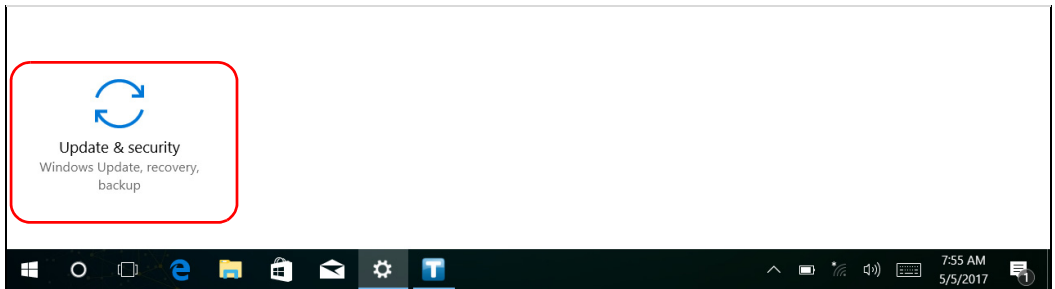

Troubleshooting

Restoring Your Unit to Normal Operation

5. Select **Recovery**.

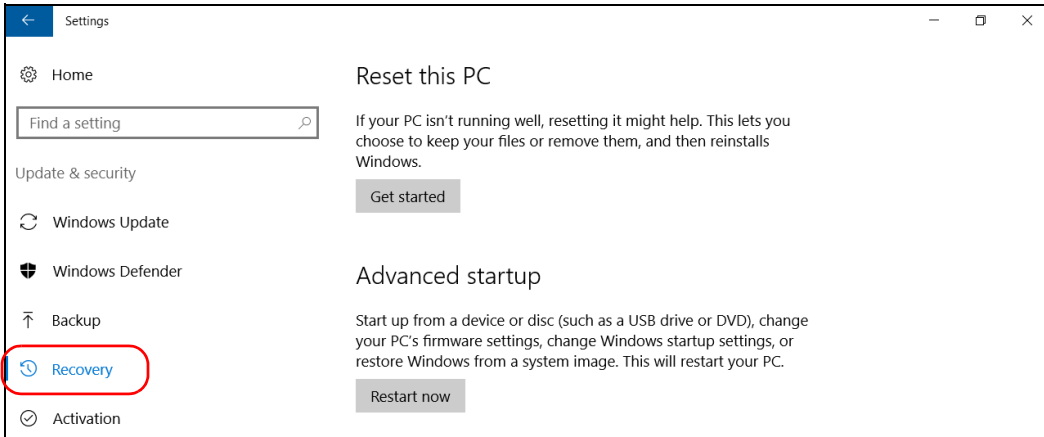

6. Under **Advanced Startup**, tap **Restart now**.

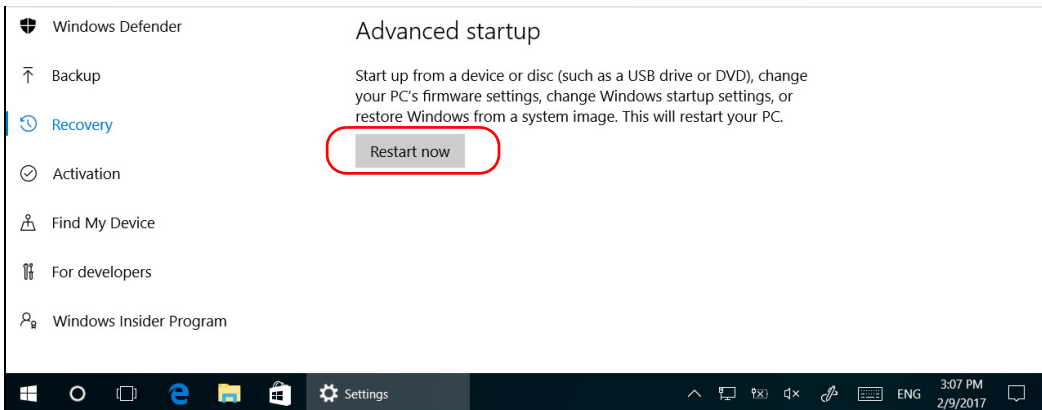

- Under **Choose an option**, tap **Troubleshoot**.

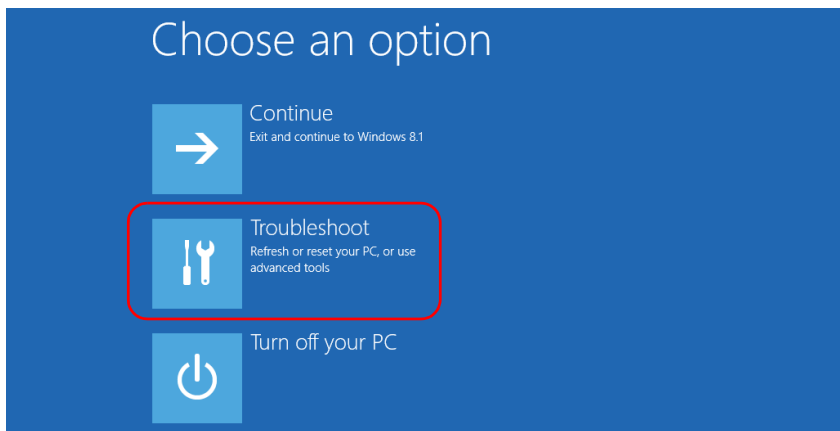

- Tap **Platform Imaging Utility** to display the corresponding application.

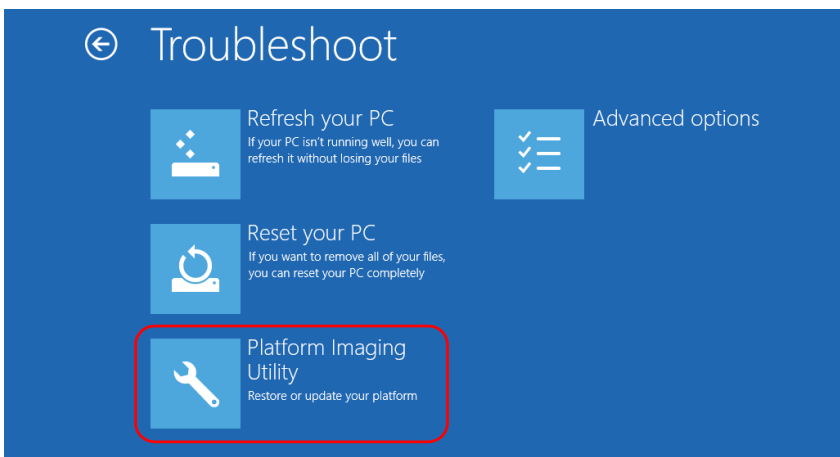

- Connect the USB key with the desired WIM file to your unit.

Troubleshooting

Restoring Your Unit to Normal Operation

- From the Platform Servicing and Imaging Utility wizard, select **Restore unit from a WIM file**, and then tap **Next**.

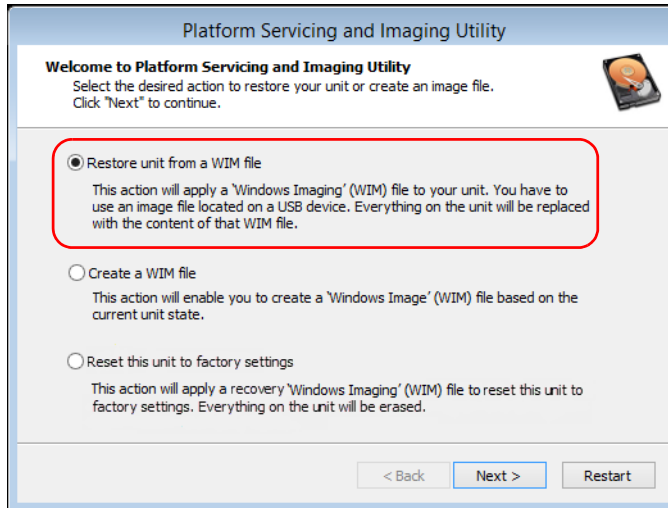

- Tap **Browse**.

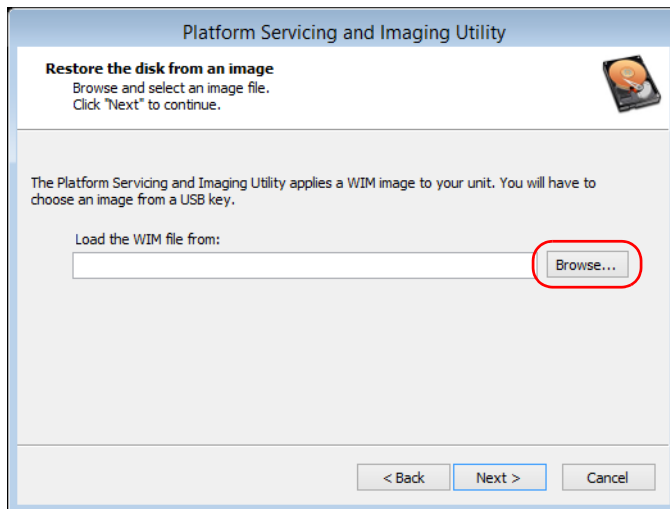

- 12.** Locate the USB key, and then double-tap its identifier to access the contents.
- 13.** Select the desired WIM file.
- 14.** Tap **Next**.

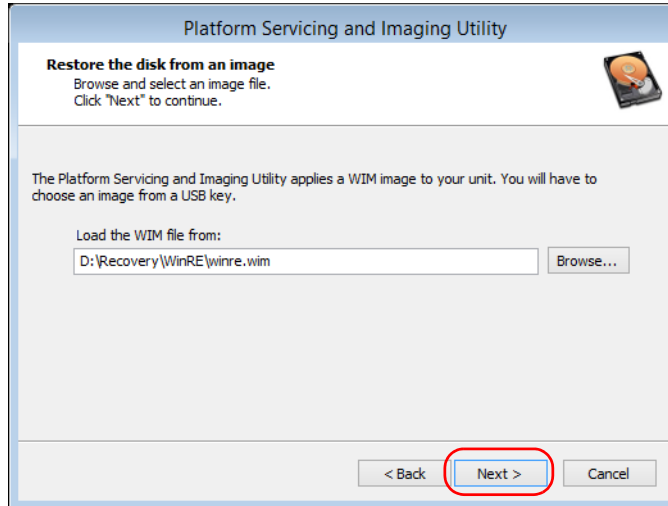



- 15.** Read the warning, and then tap **Start** to restore the unit with the selected image.
- 16.** When the operation is complete and the application prompts you, disconnect the USB key, and then tap **OK**.

The unit will restart.

Troubleshooting

Restoring Your Unit to Normal Operation

To reset your unit to its factory settings:

1. Ensure that your unit will remain powered on during the operation by connecting it to a power outlet using the provided AC adapter/charger or power cord.
2. If desired, back up your data.
3. From the task bar, tap the **Start** button (), and then **Settings** ().
4. Tap **Update & security**.

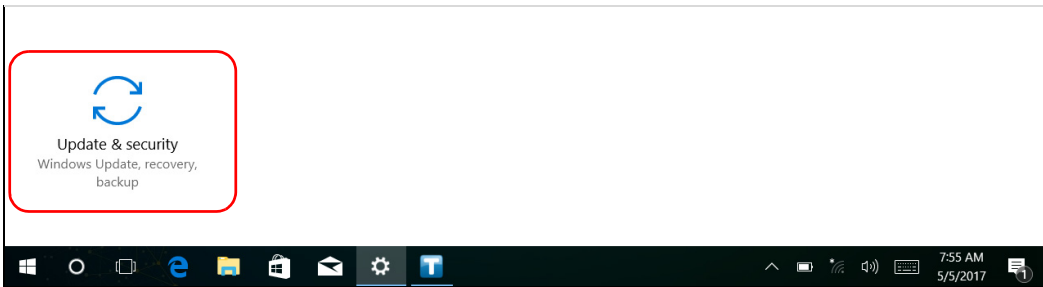

5. Select **Recovery**.

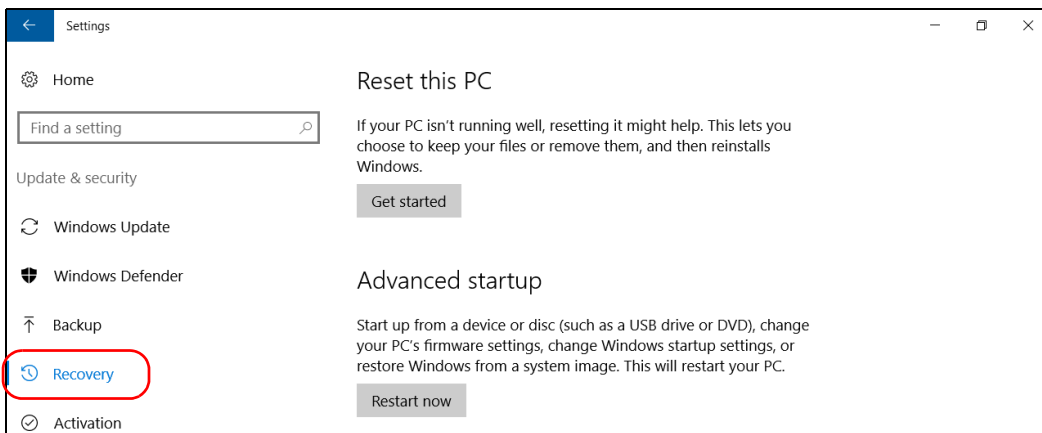

6. Under **Advanced Startup**, tap **Restart now**.

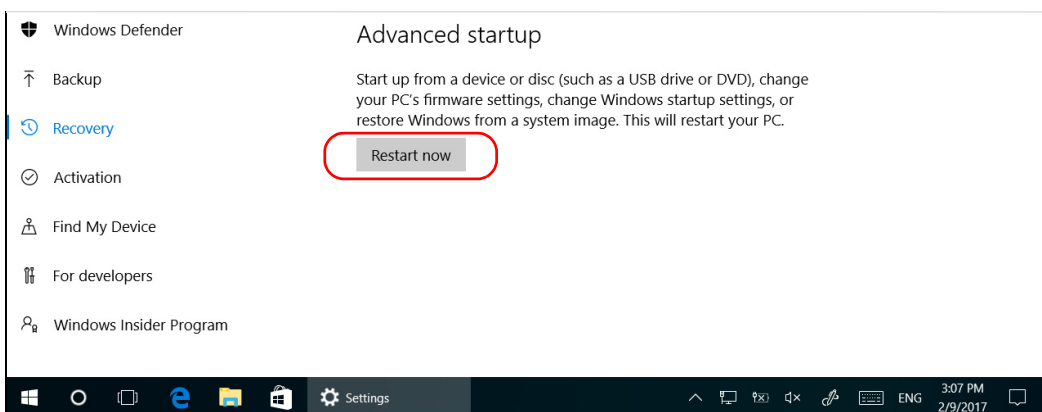

Troubleshooting

Restoring Your Unit to Normal Operation

- Under **Choose an option**, tap **Troubleshoot**.

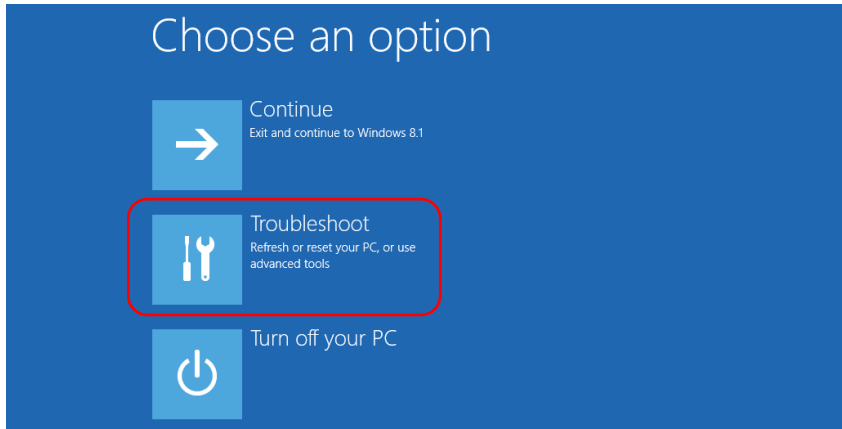

- Tap **Platform Imaging Utility** to display the corresponding application.

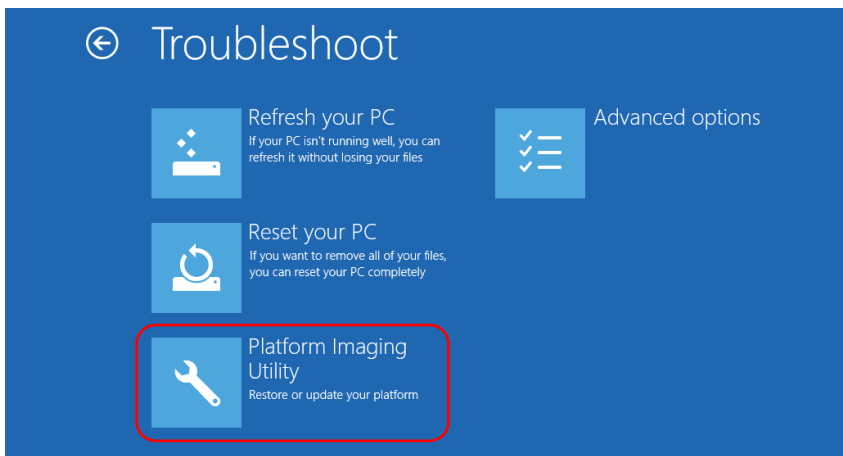

- From the Platform Servicing and Imaging Utility wizard, select **Reset this unit to factory settings**, and then tap **Next**.

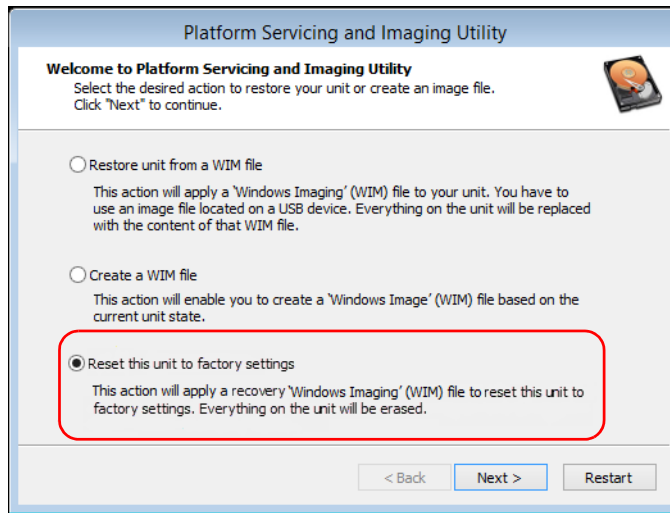

- Read the warning, and then tap **Start** to restore the unit with the selected image.
- When the operation is complete and the application prompts you, tap **OK**.
The unit will restart.
- Configure the regional parameters, and accept the license agreements as you did when you first received your unit (see *Configuring Your Unit At First Startup* on page 63).

Troubleshooting

Restoring Your Unit to Normal Operation

Windows Embedded 8 Standard and Windows 8.1 Pro

When you want to restore your unit, there are several options. The table below gives an overview of the possibilities.

Method	Description
Refresh	<ul style="list-style-type: none">➤ The unit will be reverted to its initial state.➤ All data files that were saved to the default personal folders (Documents, Pictures, etc.) will still be available once the operation is complete.➤ If you have installed products and updates since you purchased your unit, you will have to reinstall them.➤ Refer to Microsoft documentation for more information.
Reset	<ul style="list-style-type: none">➤ The unit will be reverted to its initial state.➤ All data files will be lost once the operation is complete.➤ If you have installed products and updates since you purchased your unit, you will have to reinstall them.➤ Refer to Microsoft documentation for more information.
Restore	<ul style="list-style-type: none">➤ The unit will be reverted to the state in which it was when the WIM file was created.➤ All data files will be lost once the operation is complete.➤ If you have installed products and updates since the WIM file was created, you will have to reinstall them.



IMPORTANT

- **Refresh operation:** All the data that is stored in the default personal folders will still be available once the operation is complete. However, any data stored in other folders will be lost. You may want to back up this data before refreshing your unit.
- **Reset and restore operations:** To avoid losing the data that is stored on your unit, you may want to back it up before resetting or restoring your unit. Otherwise, all your files will be lost.

Troubleshooting

Restoring Your Unit to Normal Operation



IMPORTANT

The size of the WIM will depend on the disk space that is currently used on your unit.

To avoid problems, always use a USB key with an NTFS file system, and a minimum of 16 GB of free disk space.

To create a WIM file for your unit:

1. On your unit, from the right side of the screen, swipe left to display the Charm bar.
2. Tap **Settings** > **Change PC settings**.

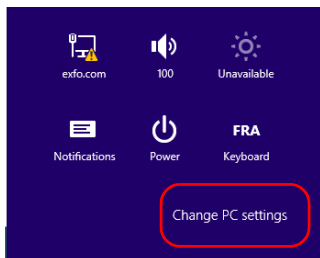

3. On an FTB-2 Pro, tap **Update and recovery**.

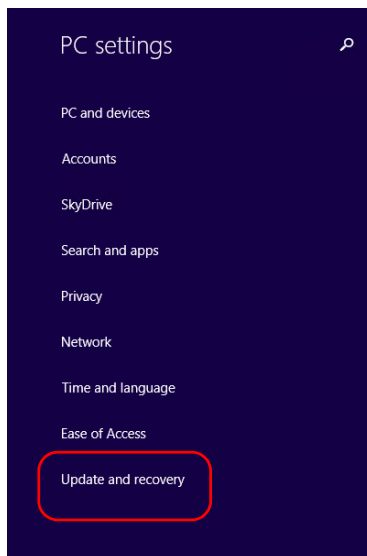

Personalize

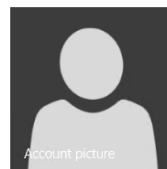

[View recently used settings](#)

Troubleshooting

Restoring Your Unit to Normal Operation

- 4. On an FTB-2 Pro, tap **Recovery**.
On an FTB-2, tap **General**, and then scroll down the list.

FTB-2 Pro

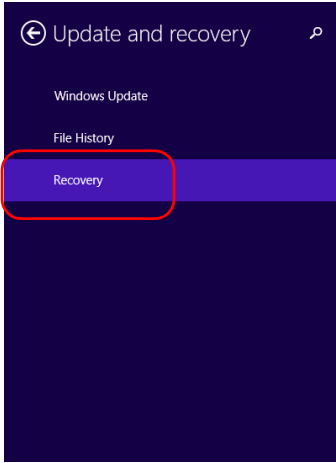

Refresh your PC without affecting your files

If your PC isn't running well, you can refresh it without losing your photos, music, videos, or other personal files.

[Get started](#)

Remove everything and reinstall Windows

If you want to recycle your PC or start over completely, you can reset it to its factory settings.

[Get started](#)

Advanced startup

Start up from a device or disc (such as a USB drive or DVD), change your PC's firmware settings, change Windows startup settings, or restore Windows from a system image. This will refresh your PC.

[Restart now](#)

FTB-2

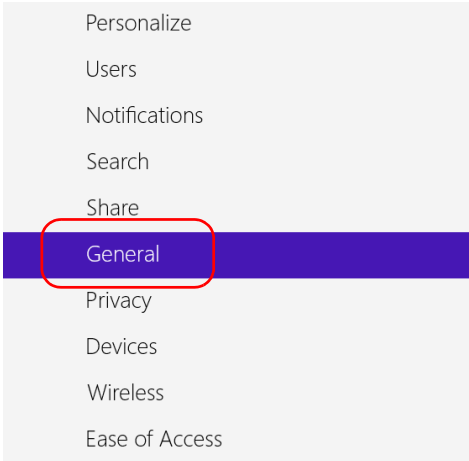

Refresh your PC without affecting your files

If your PC isn't running well, you can refresh it without losing your photos, music, videos, and other personal files.

[Get started](#)

Remove everything and reinstall Windows

If you want to recycle your PC or start over completely, you can reset it to its factory settings.

[Get started](#)

Advanced startup

Start up from a device or disc (such as a USB drive or DVD), change your PC's firmware settings, change Windows startup settings, or restore Windows from a system image. This will restart your PC.

[Restart now](#)

5. Under Advanced Startup, tap Restart now.

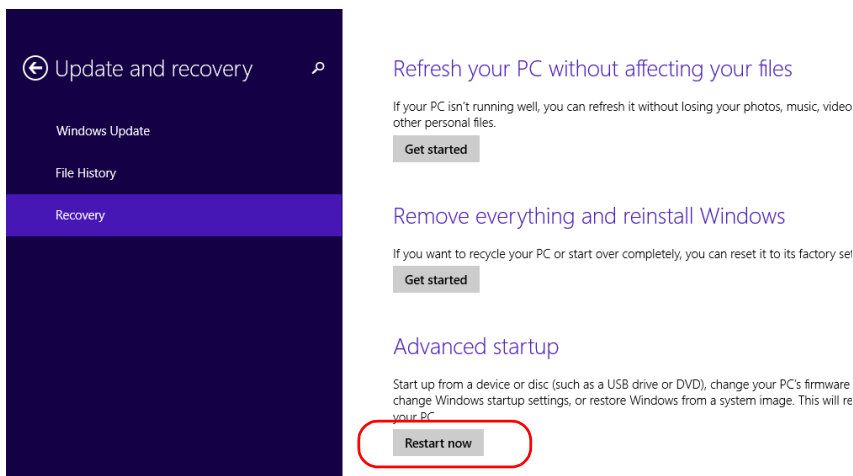

6. Under Choose an option, tap Troubleshoot.

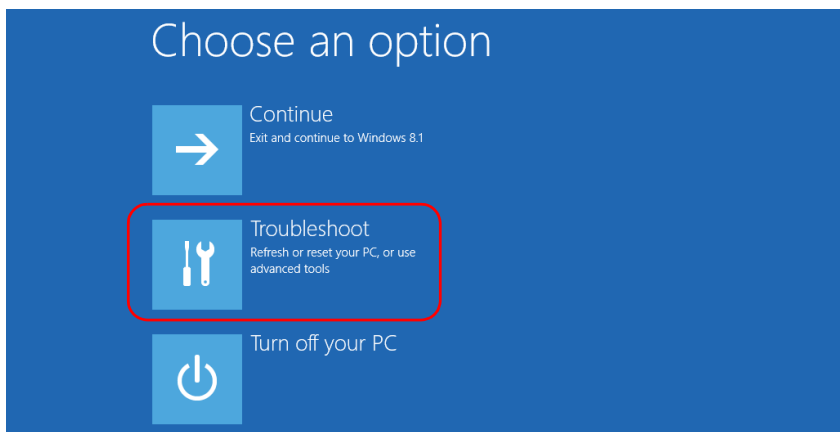

Troubleshooting

Restoring Your Unit to Normal Operation

7. Tap **Platform Imaging Utility** to display the corresponding application.

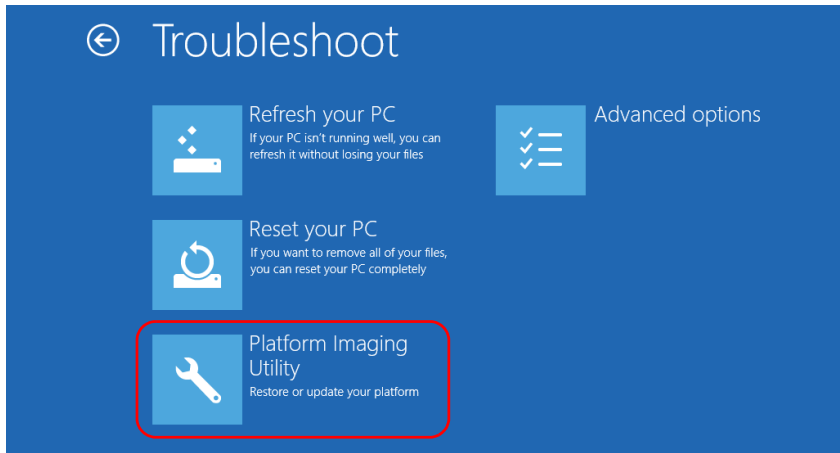

8. Connect a USB key to your unit.
9. From the Platform Servicing and Imaging Utility wizard, select **Create a WIM file**, and then tap **Next**.

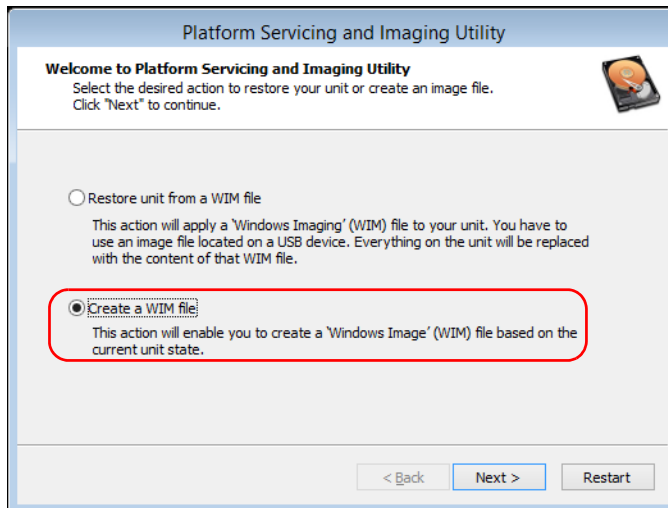

10. Tap Browse.

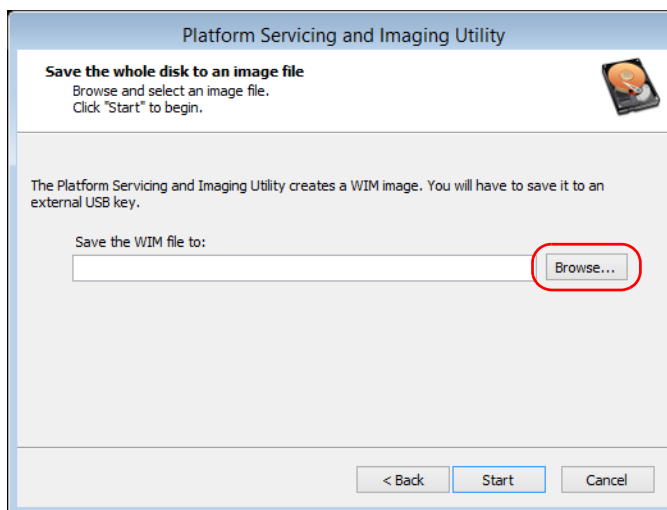

11. Locate the USB key, and then double-tap its identifier to access the contents.

12. Select the desired folder.

13. Enter a file name, and then tap **Save**.

Troubleshooting

Restoring Your Unit to Normal Operation

14. Tap **Start**.

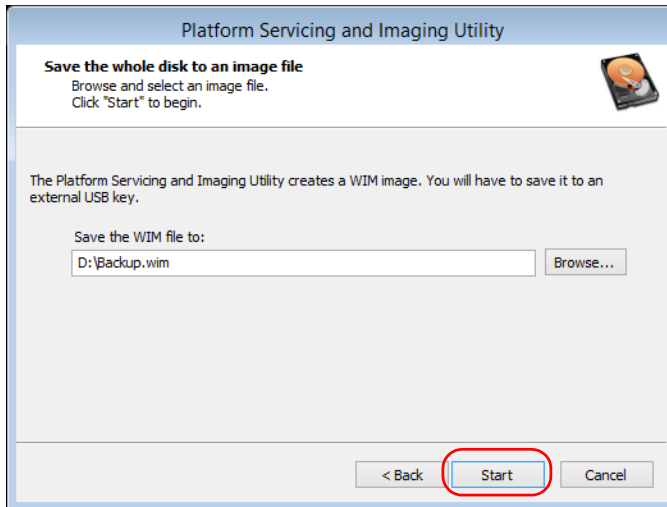

Note: *The time required to create the image varies with the configuration of your unit.*

15. When the operation is complete and the application prompts you, tap **OK**.

16. Disconnect the USB key.

17. Tap **Cancel** to return to the Welcome window of the utility.

18. Tap **Restart**.

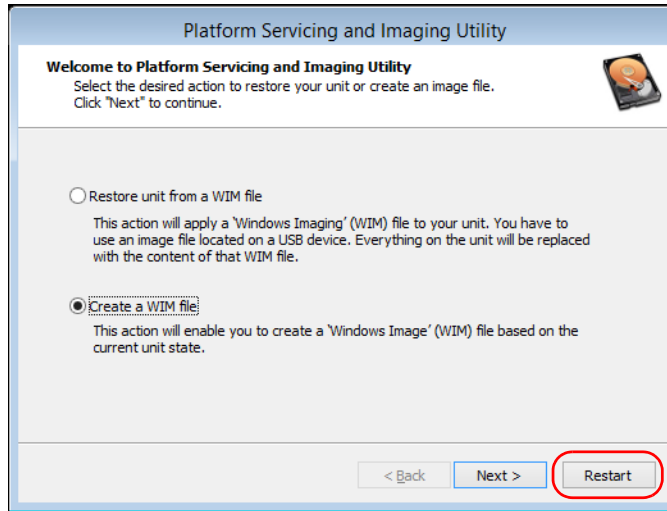

The WIM file is ready for future use.

To revert your unit to a previous state:

- 1.** Ensure that your unit will remain powered on during the operation by connecting it to a power outlet using the provided AC adapter/charger.
- 2.** If desired, back up your data.
- 3.** On your unit, from the right side of the screen, swipe left to display the Charm bar.

Troubleshooting

Restoring Your Unit to Normal Operation

4. Tap **Settings > Change PC settings.**

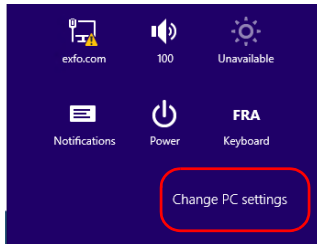

5. On an FTB-2 Pro, tap **Update and recovery.**

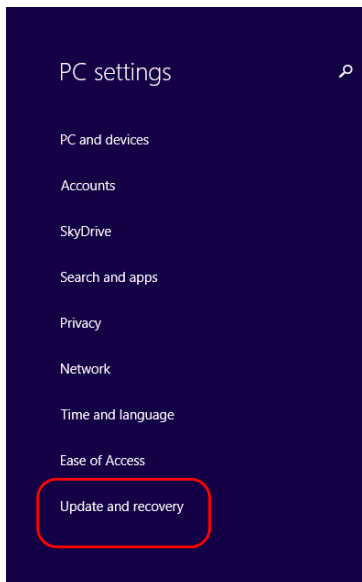

Personalize

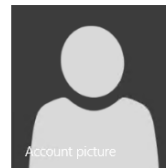

[View recently used settings](#)

6. On an FTB-2 Pro, tap **Recovery**.
On an FTB-2, tap **General**, and then scroll down the list.

FTB-2 Pro

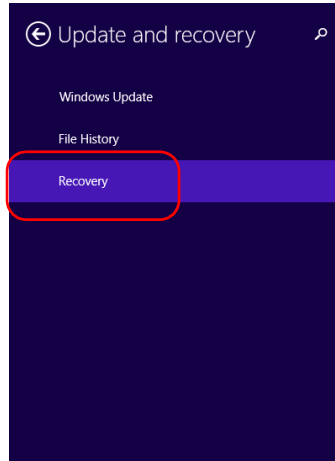

Refresh your PC without affecting your files

If your PC isn't running well, you can refresh it without losing your photos, music, videos, or other personal files.

[Get started](#)

Remove everything and reinstall Windows

If you want to recycle your PC or start over completely, you can reset it to its factory settings.

[Get started](#)

Advanced startup

Start up from a device or disc (such as a USB drive or DVD), change your PC's firmware settings, change Windows startup settings, or restore Windows from a system image. This will restart your PC.

[Restart now](#)

FTB-2

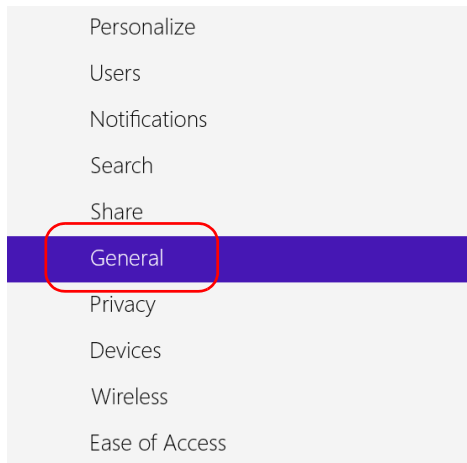

Refresh your PC without affecting your files

If your PC isn't running well, you can refresh it without losing your photos, music, videos, and other personal files.

[Get started](#)

Remove everything and reinstall Windows

If you want to recycle your PC or start over completely, you can reset it to its factory settings.

[Get started](#)

Advanced startup

Start up from a device or disc (such as a USB drive or DVD), change your PC's firmware settings, change Windows startup settings, or restore Windows from a system image. This will restart your PC.

[Restart now](#)

Troubleshooting

Restoring Your Unit to Normal Operation

- 7.** If you want to refresh or reset your unit, proceed as follows:
 - 7a.** Tap the **Get started** button corresponding to your choice.

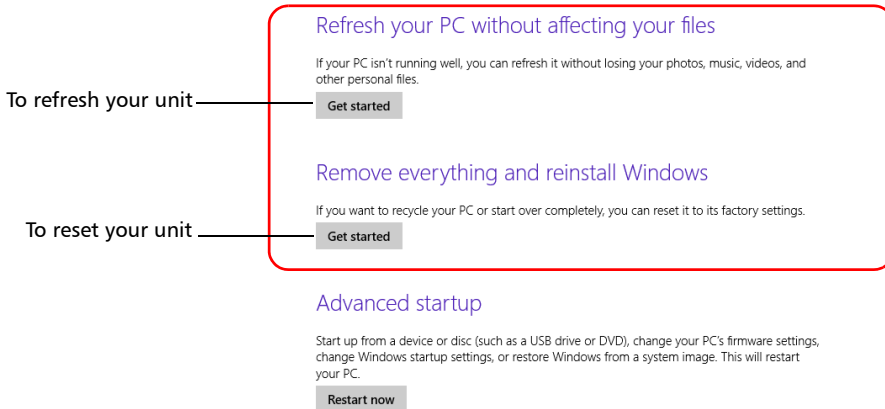

- 7b.** Follow the on-screen instructions.

8. If you want to restore your unit (with a WIM file), proceed as follows:

8a. Under **Advanced Startup**, tap **Restart now**.

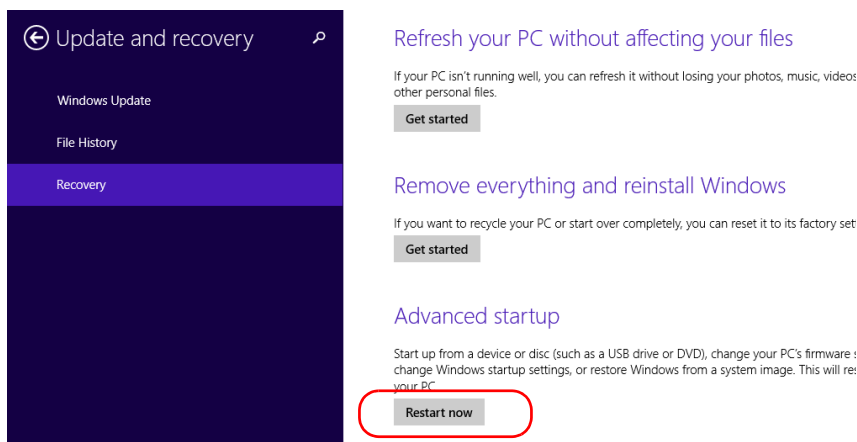

8b. Under **Choose an option**, tap **Troubleshoot**.

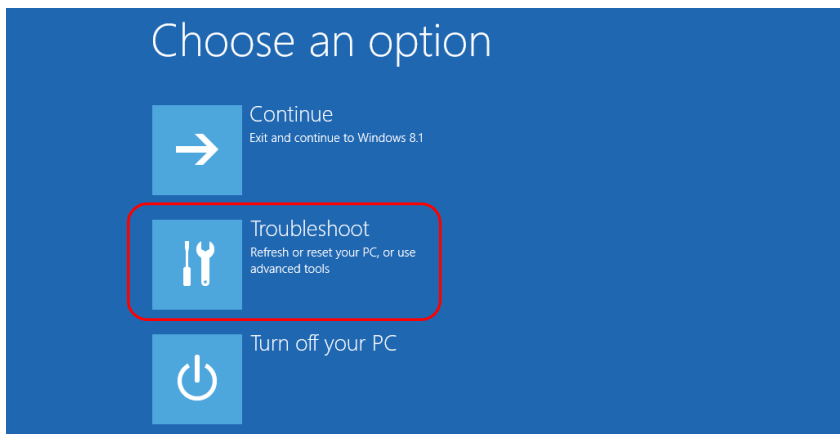

Troubleshooting

Restoring Your Unit to Normal Operation

- 8c.** Tap **Platform Imaging Utility** to display the corresponding application.

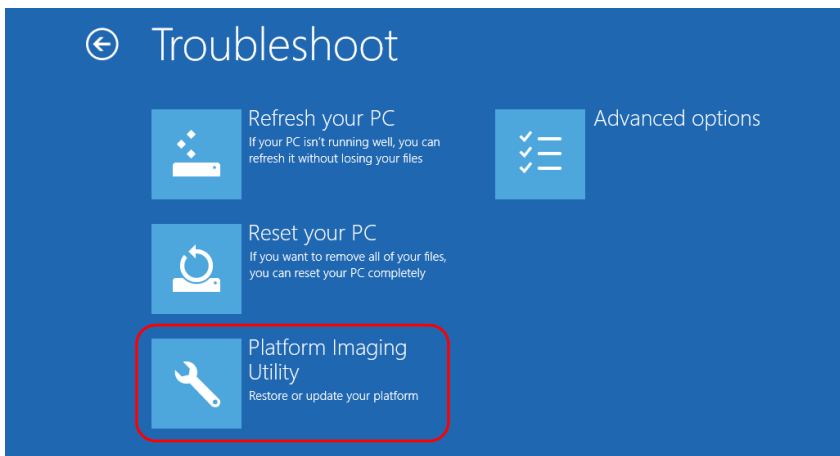

- 8d.** Connect the USB key with the desired WIM file to your unit.

- 8e.** From the Platform Servicing and Imaging Utility wizard, select **Restore unit from a WIM file**, and then tap **Next**.

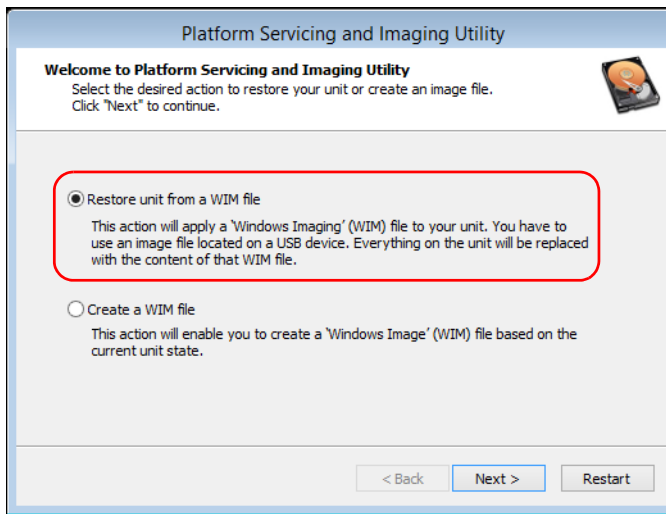

- 8f.** Tap **Browse**.

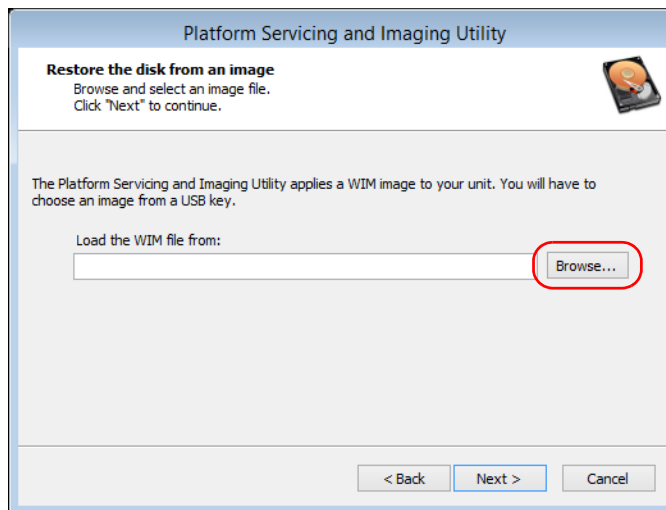

Troubleshooting

Restoring Your Unit to Normal Operation

- 8g.** Locate the USB key, and then double-tap its identifier to access the contents.
- 8h.** Select the desired WIM file.
- 8i.** Tap **Next**.

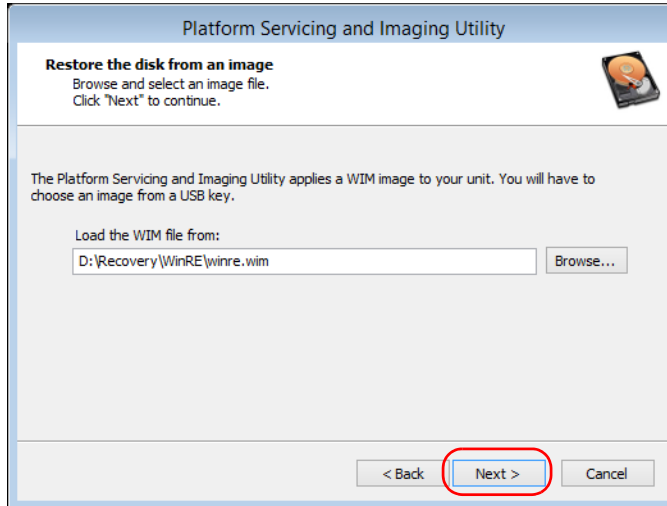

- 8j.** Read the warning, and then tap **Start** to restore the unit with the selected image.
- 8k.** When the operation is complete and the application prompts you, disconnect the USB key, and then tap **OK**.

The unit will restart.

Accessing the Online Documentation

You can access the user documentation as well as the license agreements at all times from your unit.

There are two formats of user documentation provided on your unit: online help and complete user guides (for products having safety instructions). When you open user documentation in PDF format from ToolBox X (or the configuration wizard), the files are displayed automatically in the provided PDF viewer.

Note: *The user guides of all products are available from the Library section of the EXFO Web site (www.exfo.com/library) for download in PDF format.*

To view the online help:

From ToolBox X or an instrument application, tap  (or the equivalent).

To view the documentation in PDF format:

1. From the main window, tap the **Utilities** button.
2. Tap the icon corresponding to the type of document that you want to view.

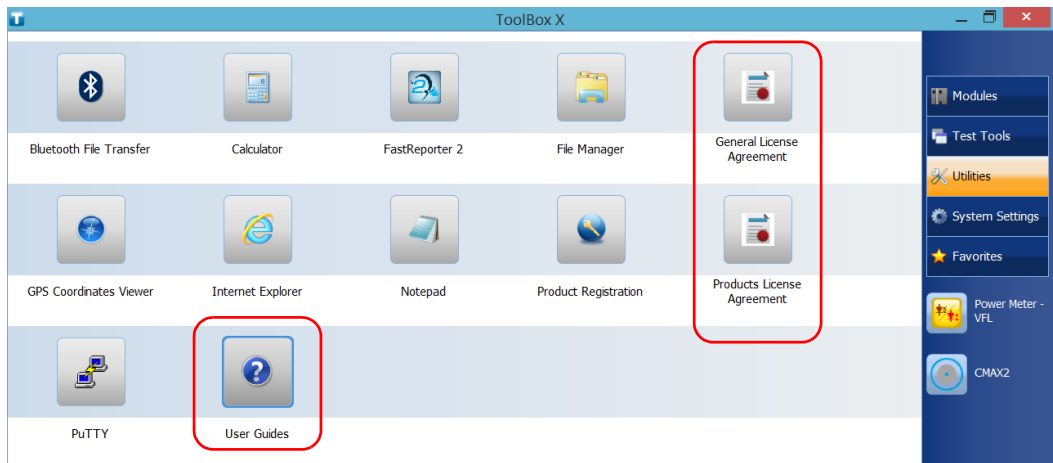

Troubleshooting

Contacting the Technical Support Group

Contacting the Technical Support Group

To obtain after-sales service or technical support for this product, contact EXFO at one of the following numbers. The Technical Support Group is available to take your calls from Monday to Friday, 8:00 a.m. to 7:00 p.m. (Eastern Time in North America).

Technical Support Group

400 Godin Avenue
Quebec (Quebec) G1M 2K2
CANADA

1 866 683-0155 (USA and Canada)
Tel.: 1 418 683-5498
Fax: 1 418 683-9224
support@exfo.com

For detailed information about technical support, and for a list of other worldwide locations, visit the EXFO Web site at www.exfo.com.

If you have comments or suggestions about this user documentation, you can send them to customer.feedback.manual@exfo.com.

To accelerate the process, please have information such as the name and the serial number (see the product identification label), as well as a description of your problem, close at hand.

Viewing System Information

You can easily access important information such as the serial number, version numbers for ToolBox X and hardware components, or network interfaces information directly from your unit. You can also find the contact information if you ever need to reach EXFO.

Retrieving the Serial Number of Your Unit

The serial number of your unit is easily accessible from ToolBox X.

Note: *You can also view the serial number on the label affixed to the back of your unit.*

To retrieve the serial number of your unit:

1. In the lower right corner of the main window, tap .
2. Tap the **Platform** tab.

The serial number is displayed.

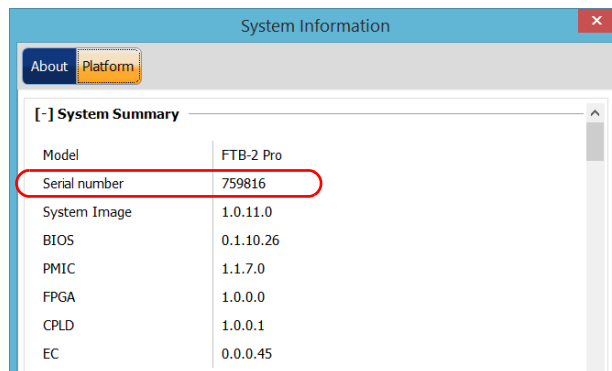

Note: *The serial numbers of your modules are visible from the **Modules** window.*

Troubleshooting

Viewing System Information

Retrieving the Component Versions

You can view the version of ToolBox X as well as those of the system image and hardware components that are installed on your unit.

To retrieve the ToolBox X version:

1. In the lower right corner of the main window, tap .
2. Tap the **About** tab.

The version number is displayed.



To retrieve the version numbers of the system image and hardware components:

1. In the lower right corner of the main window, tap .
2. Tap the **Platform** tab.

The version numbers are displayed.

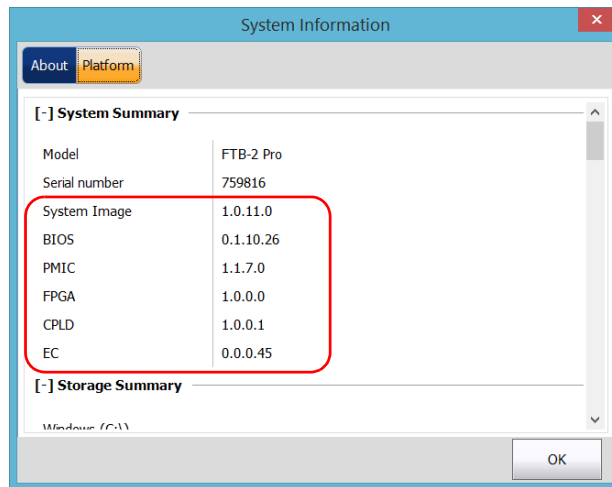

Retrieving Network Interfaces Information

You can view the information related to the network interfaces (adapters) such as the status of the interfaces, the IP address, etc.

To retrieve the information for the Ethernet and Bluetooth® network interfaces:

1. In the lower right corner of the main window, tap .
2. Tap the **Platform** tab.

The information is displayed (one section per network interface).

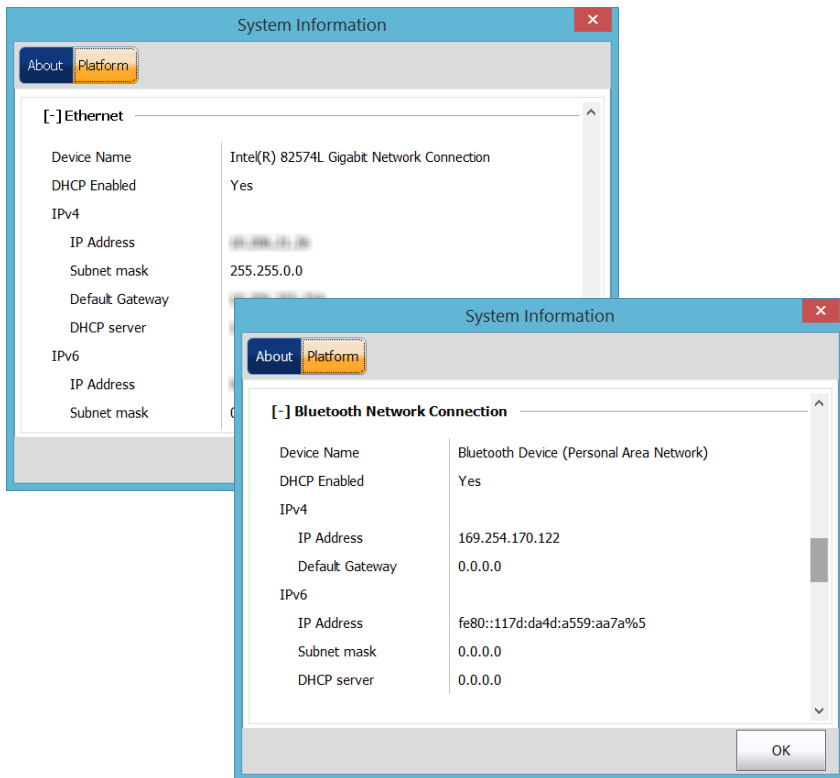

To retrieve network interfaces information for Wi-Fi:

1. From the main window, tap the **System Settings** button.
2. Tap **Control Panel**.



3. Under **Network and Internet**, tap **View network status and tasks**.

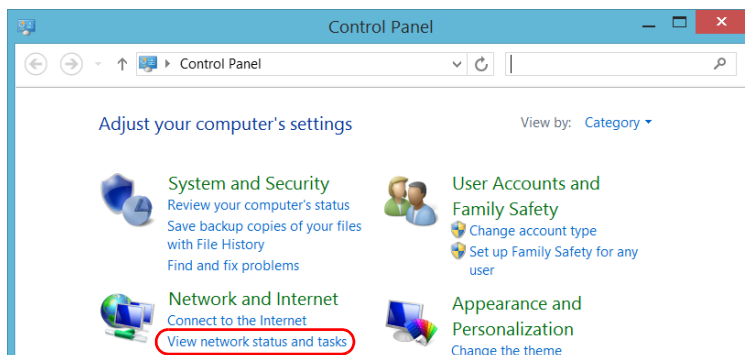

4. Tap the link corresponding to the Wi-Fi network.

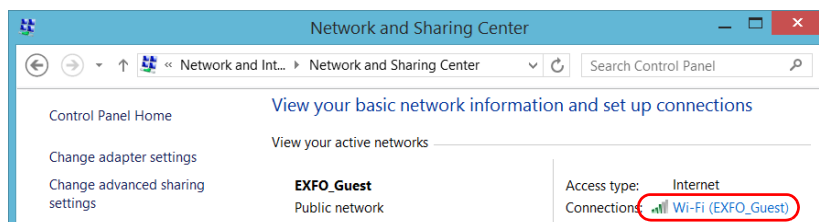

Troubleshooting

Retrieving Network Interfaces Information

- From the **Wi-Fi Status** window, tap **Details**.

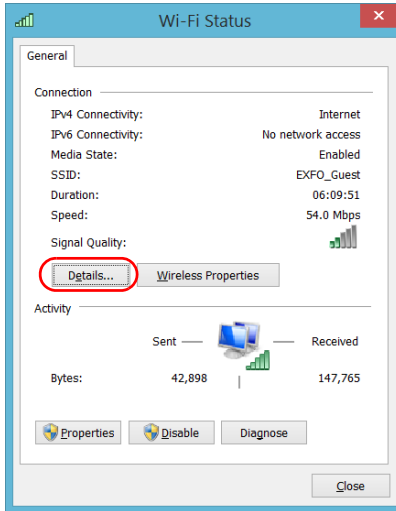

- When your work is done, close the window.

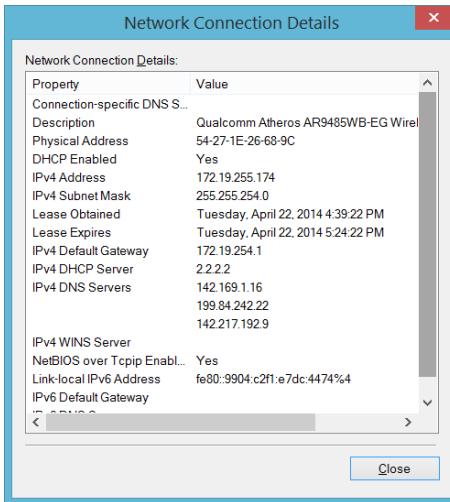

- Close all other windows to return to ToolBox X.

Retrieving the Contact Information

All the information necessary to contact EXFO is available from your unit.

To retrieve the contact information:

1. In the lower right corner of the main window, tap .
2. Tap the **About** tab.

The contact information is displayed.



Transportation

Maintain a temperature range within specifications when transporting the unit. Transportation damage can occur from improper handling. The following steps are recommended to minimize the possibility of damage:

- Pack the unit in its original packing material when shipping.
- Avoid high humidity or large temperature fluctuations.
- Keep the unit out of direct sunlight.
- Avoid unnecessary shocks and vibrations.

15 Warranty

General Information

EXFO Inc. (EXFO) warrants this equipment against defects in material and workmanship for a period of one year from the date of original shipment. EXFO also warrants that this equipment will meet applicable specifications under normal use.

During the warranty period, EXFO will, at its discretion, repair, replace, or issue credit for any defective product, as well as verify and adjust the product free of charge should the equipment need to be repaired or if the original calibration is erroneous. If the equipment is sent back for verification of calibration during the warranty period and found to meet all published specifications, EXFO will charge standard calibration fees.



IMPORTANT

The warranty can become null and void if:

- unit has been tampered with, repaired, or worked upon by unauthorized individuals or non-EXFO personnel.
- warranty sticker has been removed.
- case screws, other than those specified in this guide, have been removed.
- case has been opened, other than as explained in this guide.
- unit serial number has been altered, erased, or removed.
- unit has been misused, neglected, or damaged by accident.

THIS WARRANTY IS IN LIEU OF ALL OTHER WARRANTIES EXPRESSED, IMPLIED, OR STATUTORY, INCLUDING, BUT NOT LIMITED TO, THE IMPLIED WARRANTIES OF MERCHANTABILITY AND FITNESS FOR A PARTICULAR PURPOSE. IN NO EVENT SHALL EXFO BE LIABLE FOR SPECIAL, INCIDENTAL, OR CONSEQUENTIAL DAMAGES.

Warranty

Liability

Liability

EXFO shall not be liable for damages resulting from the use of the product, nor shall be responsible for any failure in the performance of other items to which the product is connected or the operation of any system of which the product may be a part.

EXFO shall not be liable for damages resulting from improper usage or unauthorized modification of the product, its accompanying accessories and software.

Exclusions

EXFO reserves the right to make changes in the design or construction of any of its products at any time without incurring obligation to make any changes whatsoever on units purchased. Accessories, including but not limited to fuses, pilot lamps, batteries and universal interfaces (EUI) used with EXFO products are not covered by this warranty.

This warranty excludes failure resulting from: improper use or installation, normal wear and tear, accident, abuse, neglect, fire, water, lightning or other acts of nature, causes external to the product or other factors beyond the control of EXFO.



IMPORTANT

In the case of products equipped with optical connectors, EXFO will charge a fee for replacing connectors that were damaged due to misuse or bad cleaning.

Certification

EXFO certifies that this equipment met its published specifications at the time of shipment from the factory.

Service and Repairs

EXFO commits to providing product service and repair for five years following the date of purchase.

To send any equipment for service or repair:

1. Call one of EXFO's authorized service centers (see *EXFO Service Centers Worldwide* on page 380). Support personnel will determine if the equipment requires service, repair, or calibration.
2. If equipment must be returned to EXFO or an authorized service center, support personnel will issue a Return Merchandise Authorization (RMA) number and provide an address for return.
3. If possible, back up your data before sending the unit for repair.
4. Pack the equipment in its original shipping material. Be sure to include a statement or report fully detailing the defect and the conditions under which it was observed.
5. Return the equipment, prepaid, to the address given to you by support personnel. Be sure to write the RMA number on the shipping slip. *EXFO will refuse and return any package that does not bear an RMA number.*

Note: *A test setup fee will apply to any returned unit that, after test, is found to meet the applicable specifications.*

After repair, the equipment will be returned with a repair report. If the equipment is not under warranty, you will be invoiced for the cost appearing on this report. EXFO will pay return-to-customer shipping costs for equipment under warranty. Shipping insurance is at your expense.

Routine recalibration is not included in any of the warranty plans. Since calibrations/verifications are not covered by the basic or extended warranties, you may elect to purchase FlexCare Calibration/Verification Packages for a definite period of time. Contact an authorized service center (see *EXFO Service Centers Worldwide* on page 380).

Warranty

EXFO Service Centers Worldwide

EXFO Service Centers Worldwide

If your product requires servicing, contact your nearest authorized service center.

EXFO Headquarters Service Center

400 Godin Avenue
Quebec (Quebec) G1M 2K2
CANADA

1 866 683-0155 (USA and Canada)
Tel.: 1 418 683-5498
Fax: 1 418 683-9224
support@exfo.com

EXFO Europe Service Center

Winchester House, School Lane
Chandlers Ford, Hampshire S053 4DG
ENGLAND

Tel.: +44 2380 246800
Fax: +44 2380 246801
support.europe@exfo.com

EXFO Telecom Equipment (Shenzhen) Ltd.

3rd Floor, Building C,
FuNing Hi-Tech Industrial Park, No. 71-3,
Xintian Avenue,
Fuyong, Bao'An District,
Shenzhen, China, 518103

Tel: +86 (755) 2955 3100
Fax: +86 (755) 2955 3101
support.asia@exfo.com

To view EXFO's network of partner-operated Certified Service Centers nearest you, please consult EXFO's corporate website for the complete list of service partners:

<http://www.exfo.com/support/services/instrument-services/exfo-service-centers>.

A Data Types

The following section provides an overview of the most common data types that may appear in EXFO's documentation on commands and queries. The information is supplied for guidance only.

For more detailed information, please refer to IEEE 488.2 and SCPI standards.

Data types are divided into two groups: <PROGRAM DATA> for the types that are used when you want to send messages to a device and <RESPONSE DATA> for the types that are used when a device sends responses to the controller.

The data types are presented in graphics often referred to as "railroad diagrams". The following example illustrates how to interpret such diagrams.

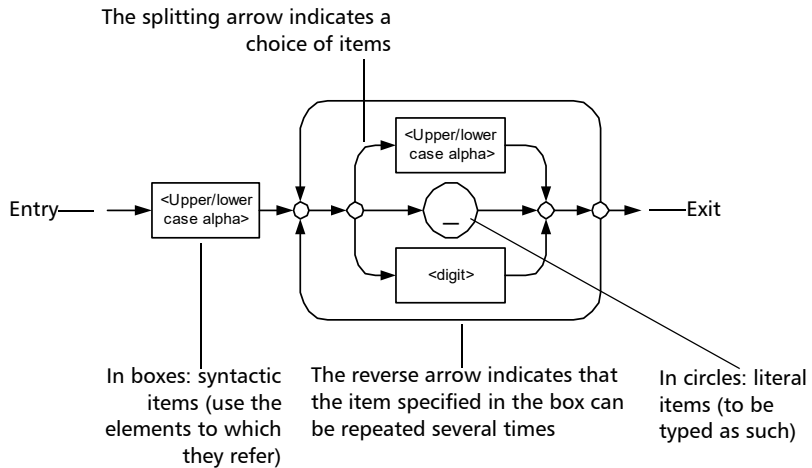

Applicable Data Types for Input—IEEE 488.2

- <PROGRAM MESSAGE TERMINATOR>

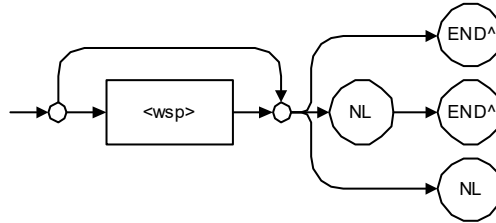

In the diagram above,

- “NL” corresponds to ASCII character code 10, in decimal (0A in binary)
- “END ^” corresponds to the last data byte of the message sent with EOI = True and ATN = False

➤ **<CHARACTER PROGRAM DATA>**

This data type will be used to send short mnemonics when a *<DECIMAL NUMERIC PROGRAM DATA>* cannot be used.

Examples: TRIANGLEWAVE, NCONTINUOUS

➤ **<DECIMAL NUMERIC PROGRAM DATA>** (or **<NRf>**)

This data type includes **<NR1>**, **<NR2>** and **<NR3>** data types. It will be used for decimal fractions with or without an exponent. Instruments will adapt the values they receive to fit their degree of precision. For example, if an instrument has a precision of two digits after the decimal point and the incoming value is 12.048, this value will be rounded off to 12.05.

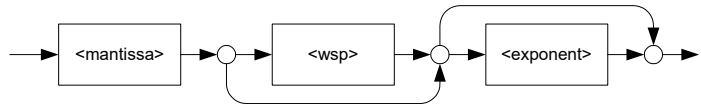

The second diagram below illustrates the **<mantissa>** syntax.

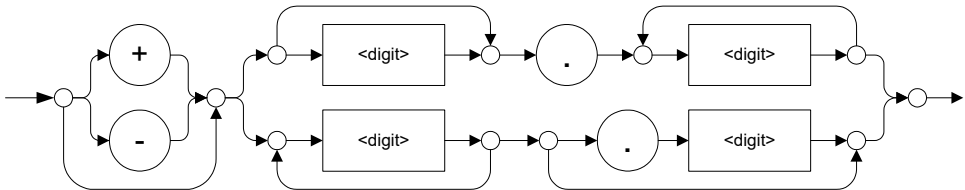

The third diagram illustrates the **<exponent>** syntax.

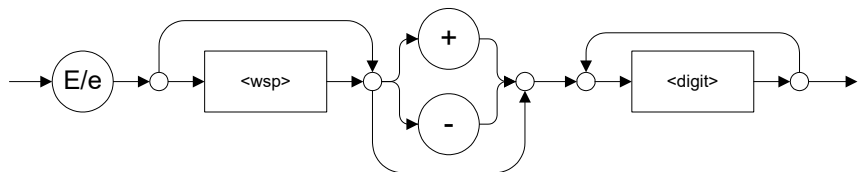

Examples: +2.0 e5, -.56E+4, 6.5e-10

Data Types

Applicable Data Types for Input—IEEE 488.2

➤ <NON-DECIMAL NUMERIC PROGRAM DATA>

This data type will be used for integer representation in hexadecimal (base 16), octal (base 8) or binary (base 2). The numeric representations will begin with “#H” for hexadecimal, “#Q” for octal and “#B” for binary.

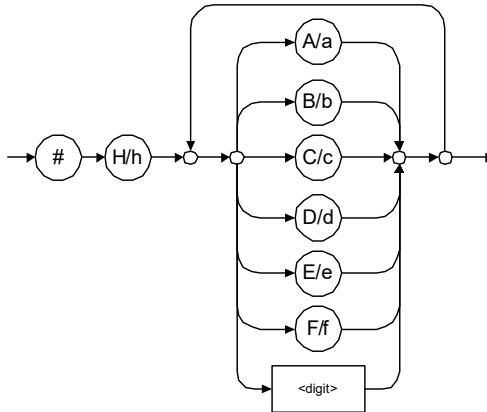

Examples: #Hf3bc015d, #h01a4, #hfe

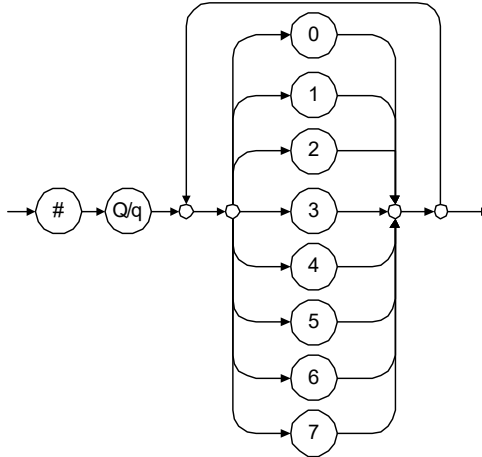

Examples: #Q1234567, #q1275, #q07

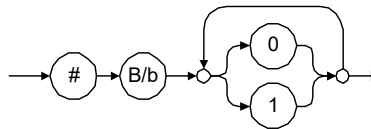

Examples: #B10010111, #b10110, #b1100

Data Types

Applicable Data Types for Input—IEEE 488.2

➤ <STRING PROGRAM DATA>

This data type will be used for strings containing 7-bit ASCII characters that have to be enclosed in either single- or double-quotes delimiters.

If a string needs to contain a character that is exactly the same as the delimiter, make sure to double the character to avoid syntax errors.

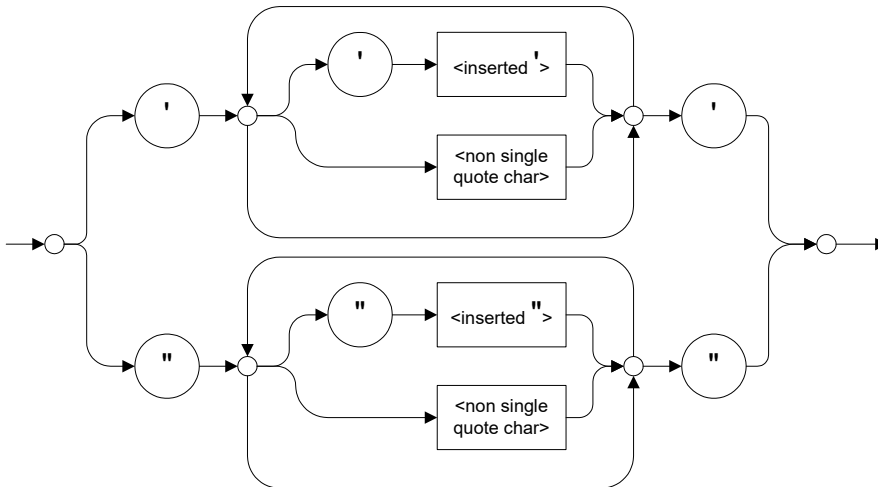

Examples: "SCPI Commands", 'SCPI Commands', "SCPI 'Commands'",
'SCPI "Commands"', "SCPI ""Commands""", 'SCPI ""Commands""'

➤ <ARBITRARY BLOCK PROGRAM DATA>

This data type is used to send blocks of arbitrary 8-bit information when you need to work with large amounts of data.

The actual length of the data that you send has the following structure:

- The first byte contains the # character.
- The byte that immediately follows contains the number of subsequent bytes that you have to check to obtain the total length.

Note: *If you use a zero as the first digit (#0), it has to be followed by a <PROGRAM MESSAGE TERMINATOR > so that the device will detect the end of the <ARBITRARY BLOCK PROGRAM DATA>. This will also force immediate termination of the message.*

For example, if you send the following data (here, values are expressed in decimal instead of binary for easier readability):

2 1 3 7 6 8 9 2 ...

The byte that immediately follows the # contains 2, which means that you would have to read the two following bytes to know the length (in bytes) of the retrieved data. The bytes indicate 1 and 3. The length will then be 13 bytes. The actual response will begin at byte number 5, in this case.

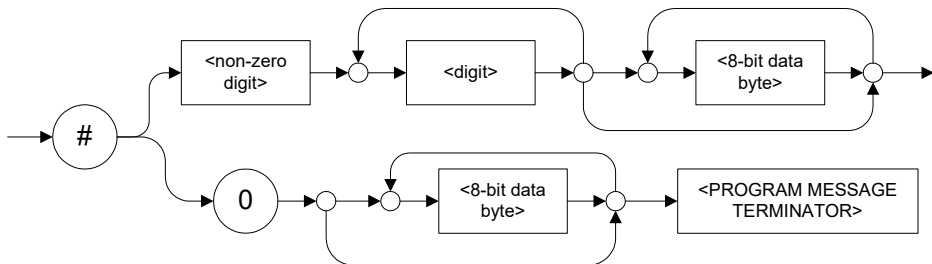

Data Types

Applicable Data Types for Input—IEEE 488.2

► <SUFFIX PROGRAM DATA>

This data type is used when units and multipliers have to be sent.

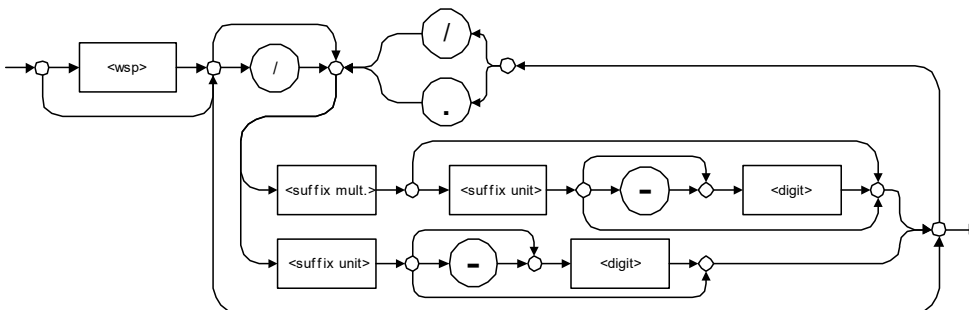

Examples: nm, kHz, km/s², uW

A relative unit (dB) can be referenced to an absolute level, as shown on the following diagram.

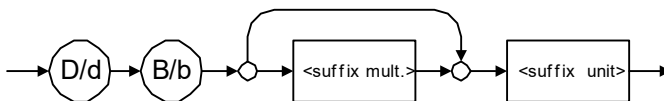

Examples: db, dbm, dBW

The following table illustrates the possible forms for <suffix mult.>:

Name	Value	Mnemonic
Exa	1E18	EX
Peta	1E15	PE
Tera	1E12	T
Giga	1E9	G
Mega	1E6	MA
Kilo	1E3	K
Milli	1E-3	M
Micro	1E-6	U
Nano	1E-9	N
Pico	1E-12	P
Femto	1E-15	F
Atto	1E-18	A

Data Types

Applicable Data Types for Input—IEEE 488.2

The table below gives the possible forms for <suffix unit> :

Reference Unit	Suffix Unit
Degrees	DEG
Radians	RAD
Amperes	A
Volts	V
Hertz	HZ
Meters	M
Watts	W
DBs ref to 1mW	DBM
Decibels	DB
Degrees Celsius	CEL
Degrees Fahrenheit	FAR
Kelvins	K
Seconds	S
Hours	HR
Minutes	MIN

Applicable Data Types for Output —IEEE 488.2

- <RESPONSE MESSAGE TERMINATOR>

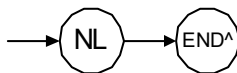

In the diagram above,

- “NL” corresponds to ASCII character code 10, in decimal (0A in binary)
- “END ^” corresponds to the last data byte of the message sent with EOI = True and ATN = False
- <CHARACTER RESPONSE DATA>

This data type will be used by a device to return short mnemonics when a <DECIMAL NUMERIC PROGRAM DATA> cannot be used. The returned information is sent in the long form and in upper case.

Examples: TRIANGLEWAVE, NCONTINUOUS

Data Types

Applicable Data Types for Output —IEEE 488.2

- <NR1 NUMERIC RESPONSE DATA> (or <NR1>)

This data type will be used by a device to return positive or negative integers.

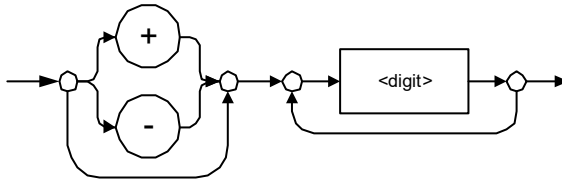

Examples: 4, -23, 90

- <NR2 NUMERIC RESPONSE DATA> (or <NR2>)

This data type will be used by a device to return positive or negative real numbers (fixed-point numbers).

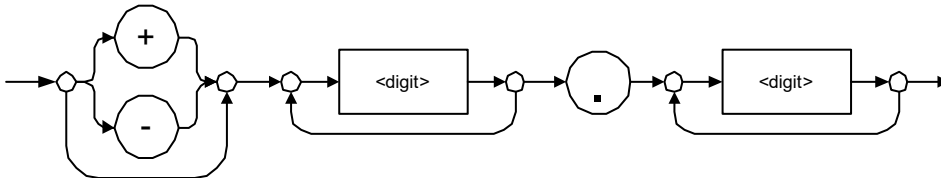

Examples: 23.45, 1.22, -4.55

➤ <NR3 NUMERIC RESPONSE DATA> (or <NR3>)

This data type will be used by a device to return positive or negative exponential numbers (floating-point numbers).

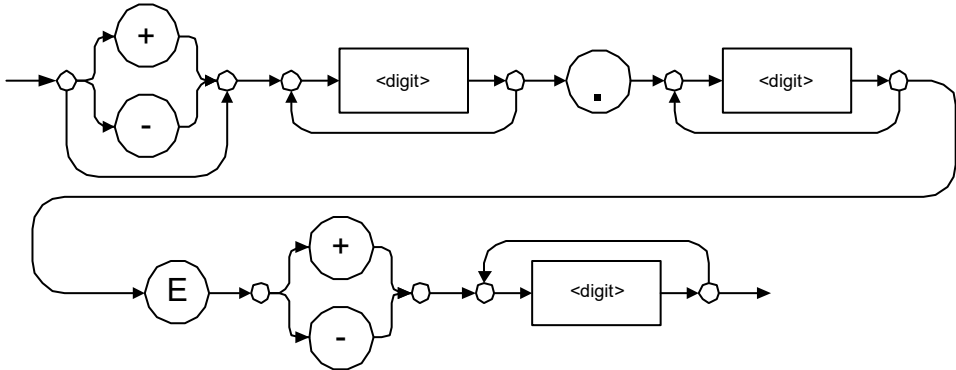

Examples: 4.3E-3, -8.9456E8, 123E-5

Data Types

Applicable Data Types for Output —IEEE 488.2

➤ **Special Numeric Values Received on Output**

In some cases, an instrument may send values indicating that an unusual event has occurred. The following tables present the possible values.

Value is	ASCII 4 bytes	PACKED 4 bytes
Under range	2143289345.000000	7FC00001
Over range	2143289346.000000	7FC00002
Invalid	2143289347.000000	7FC00003
Inactive	2143289348.000000	7FC00004

Value is	ASCII 8 bytes	PACKED 8 bytes
Under range	9221120237577961472	7FF8000020000000
Over range	9221120238114832384	7FF8000040000000
Invalid	9221120238651703296	7FF8000060000000
Inactive	9221120239188574208	7FF8000080000000

► <HEXADECIMAL NUMERIC RESPONSE DATA>

This data type will be used by a device to return integer representations in hexadecimal (base 16).

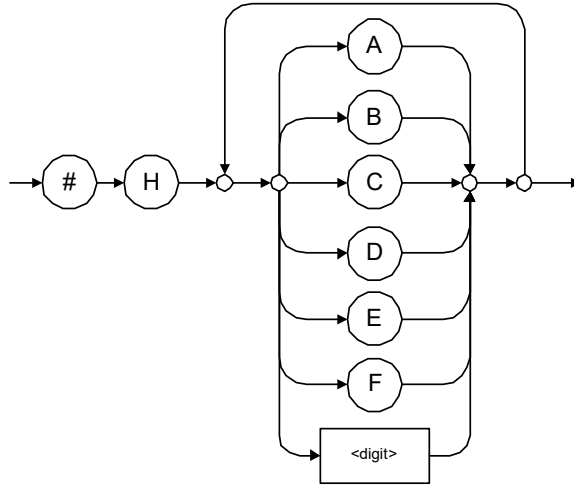

Examples: #HA3C5, #H0123C, #H010F

Data Types

Applicable Data Types for Output —IEEE 488.2

➤ <OCTAL NUMERIC RESPONSE DATA>

This data type will be used by a device to return integer representations in octal (base 8).

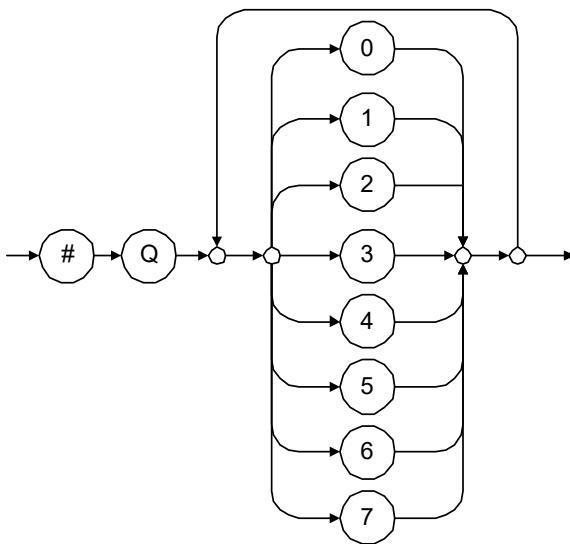

Examples: #Q753214, #Q0124, #Q0725

➤ <BINARY NUMERIC RESPONSE DATA>

This data type will be used by a device to return integer representations in binary (base 2).

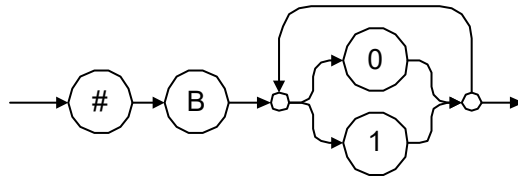

Examples: #B11011110101, #B110100, #B0100

➤ <STRING RESPONSE DATA>

This data type will be used by a device to return strings containing 7-bit ASCII characters and especially when text has to be displayed since even the non-printable characters are also returned.

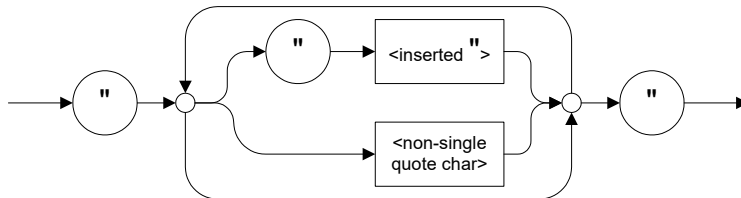

Examples: "SCPI Commands", "SCPI ""Commands""

Data Types

Applicable Data Types for Output —IEEE 488.2

➤ <DEFINITE LENGTH ARBITRARY BLOCK RESPONSE DATA>

This data type is used by a device to return blocks of 8-bit binary information with a fixed and predetermined length.

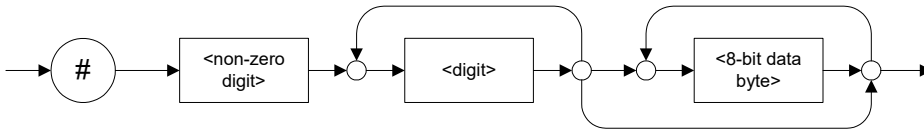

The actual length of the retrieved data has the following structure:

- The first byte contains the # character.
- The byte that immediately follows contains the number of subsequent bytes that you have to check to know the total length.

For example, if you receive this response (here, values are expressed in decimal instead of binary for easier readability):

2 1 3 7 6 8 9 2 ...

The byte that immediately follows the # contains 2, which means that you have to read the two following bytes to know the length (in bytes) of the retrieved data. The bytes indicate 1 and 3. The length will then be 13 bytes. The actual response will begin at byte number 5, in this case.

Examples: #14<DAB> <DAB> <DAB> <DAB> ,

#3004<DAB> <DAB> <DAB> <DAB>

where “<DAB>” stands for data byte

➤ <INDEFINITE LENGTH ARBITRARY BLOCK RESPONSE DATA>

This data type is used by a device to return blocks of 8-bit binary information when the block length was not predefined or when data has to be computed later.

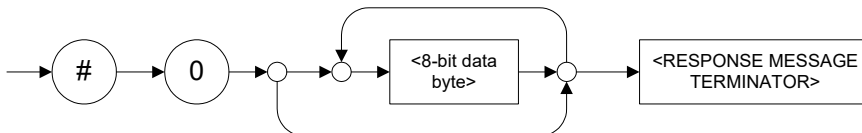

Note: *If you receive a zero as the first digit (#0), it is necessarily followed by a <RESPONSE PROGRAM MESSAGE TERMINATOR> so that you will detect the end of the <INDEFINITE LENGTH ARBITRARY BLOCK RESPONSE DATA>.*

Example: #0<DAB><DAB><DAB><DAB><terminator> where “<DAB>” stands for data byte.

Data Types

Applicable Data Types for Output —IEEE 488.2

➤ <SUFFIX RESPONSE DATA>

This data type is used by a device to return units and multipliers.

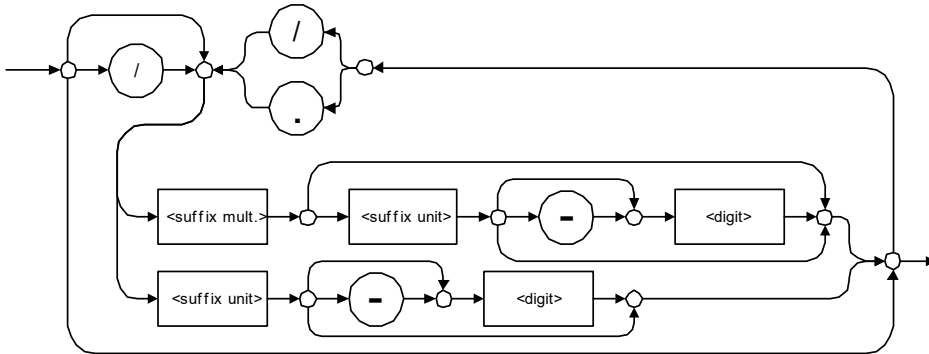

Examples: DBW, W, KHZ

➤ <ARBITRARY ASCII RESPONSE DATA>

This data type is used by a device to return information when it is impossible to use any other data type.

Example: To the *IDN? query, the device will return this response in an arbitrary ASCII bytes format:

EXFO E.O. Engineering,,125-2A55,1.0.1.97

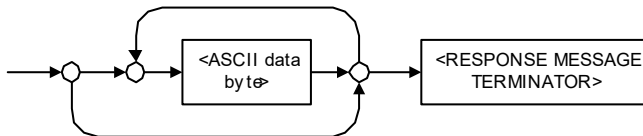

Applicable Data Types for Input—SCPI

SCPI data types include the IEEE 488.2 data types (see *Applicable Data Types for Input—IEEE 488.2* on page 382) with certain additional restrictions.

- `<numeric_value>`: abbreviated form of the decimal numeric element. It differs from the `<DECIMAL NUMERIC PROGRAM DATA>` “`<NRf>`” described in IEEE 488.2.

Several forms of `<CHARACTER PROGRAM DATA>` are defined as special forms of numbers. These are: MINimum, MAXimum, DEFault, UP, DOWN, Not A Number (NAN), INFinity and Negative INFinity (NINF). The following special forms are likely to be used by EXFO’s instruments in certain commands or queries:

- DEFault: This special `<numeric_value>` parameter forces the instrument to select a value, which is deemed to be convenient to the user.
- MINimum|MAXimum: These special `<numeric_value>` parameters refer to the instrument’s limit values. MINimum corresponds to the value closest to negative infinity that the function can accept. MAXimum corresponds to the largest value that the function can accept.
- `<Boolean Program Data>`: This form is often used as a shorthand of the `<DECIMAL NUMERIC PROGRAM DATA>`ON|OFF form.

`<Boolean Program Data>` parameters have a value of 0 or 1 and are not followed by any unit.

On input, an `<NRf>` is rounded to an integer.

A non-zero result is interpreted as 1.

ON and OFF are accepted on input for readability purposes. They correspond respectively to 1 and 0. However, on output, they appear as 1 or 0, never ON or OFF.

Data Types

Special Numeric Values Received on Output

Special Numeric Values Received on Output

It is possible that an instrument returns unusual values in certain cases. For information on these values, see Applicable Data Types for Output —IEEE 488.2 *on page 391*.

B *IEEE 488.2 and Specific Command Reference*

This chapter presents detailed information about the commands and queries supplied with your unit.

IEEE 488.2 Commands–Quick Reference

Your unit recognizes the required commands identified in IEEE 488.2. The table below summarizes these commands. These commands are fully explained on the following pages.

Command	Function
*CLS	Clear status command
*ESE	Standard event status enable command
*ESE?	Standard event status enable query
*ESR?	Standard event status register query
*IDN?	Identification query
*OPC	Operation complete command
*OPC?	Operation complete query
*RST	Reset command
*SRE	Service request enable command
*SRE?	Service request enable query
*STB?	Read status byte query
*TST?	Self-test query
*WAI	Wait for pending operations to be completed

IEEE 488.2 Required Commands

		*CLS
Description	The *CLS command clears the Standard Event Status Register and the Error/Event Queue.	
Syntax	*CLS	
Parameter(s)	None	

ESE*Description**

The *ESE command sets the Standard Event Status Enable Register bits, as defined in the table below. This register contains a mask value for the bits to be enabled in the Standard Event Status Register.

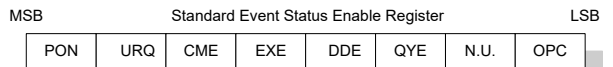
**Syntax**

*ESE<wsp> <RegisterValue>

Parameter(s)

RegisterValue:

The program data syntax for <RegisterValue> is defined as a <DECIMAL NUMERIC PROGRAM DATA> element.

The <RegisterValue>, expressed in base 2, represents the bit values of the Standard Event Status Enable Register.

IEEE 488.2 and Specific Command Reference

IEEE 488.2 Required Commands

***ESE**

The table below shows the contents of this register.

Bit	Weight	Meaning
PON	128	Power ON Enable
URQ	64	User ReQuest Enable
CMD	32	CoMmanD Error Enable
EXE	16	Execution Error Enable
DDE	8	Device Dependent Error Enable
QRY	4	QueRry Error Enable
N.U.	2	Not used
OPC	1	Operation Complete Enable

A value of 1 in the Enable Register enables the corresponding bit in the Status Register, a value of 0 disables the bit. The value of the <RegisterValue> shall be in the range of 0 through 255.

Example(s)

*ESE 25
where 25 = (bit EXE, bit DDE and bit OPC)

*ESE 0
clears the content of the Standard Event Status Enable register

See Also

*ESE?
*ESR?

*ESE?

Description

With the *ESE? query you can determine the current contents of the Standard Event Status Enable Register. See the contents of this register below.

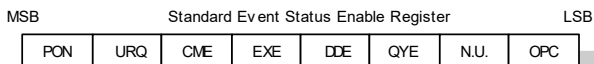
**Syntax**

*ESE?

Parameter(s)

None

Response Syntax

<RegisterValue>

IEEE 488.2 and Specific Command Reference

IEEE 488.2 Required Commands

***ESE?**

Response(s)

RegisterValue:

The response data syntax for <RegisterValue> is defined as a <NR1 NUMERIC RESPONSE DATA> element.

The <RegisterValue> ranges from 0 through 255.

The <RegisterValue> value expressed in base 2 (binary) represents the bit values of the Standard Event Status Enable register. See below.

Bit	Weight	Meaning
PON	128	Power ON Enable
URQ	64	User ReQuest Enable
CMD	32	CoMmanD Error Enable
EXE	16	Execution Error Enable
DDE	8	Device Dependent Error Enable
QRY	4	QueRry Error Enable
N.U.	2	Not used
OPC	1	Operation Complete Enable

Example(s)

*ESE? returns 133
where 133 = (bit PON, bit QYE and bit OPC)

See Also

*ESE
*ESR?

*ESR?

Description With the *ESR? query you can determine the current contents of the Standard Event Status Register. Reading the Standard Event Status Register clears it. See the contents of this register below.

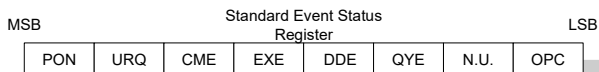

Syntax *ESR?

Parameter(s) None

Response Syntax <RegisterValue>

IEEE 488.2 and Specific Command Reference

IEEE 488.2 Required Commands

*ESR?

Response(s)

RegisterValue:

The response data syntax for <RegisterValue> is defined as a <NR1 NUMERIC RESPONSE DATA> element.

The <RegisterValue> ranges from 0 through 255.

The <RegisterValue> value expressed in base 2 (binary) represents the bit values of the Standard Event Status register. See below.

Bit	Weight	Meaning
PON	128	Power ON Enable
URQ	64	User ReQuest Enable
CMD	32	CoMmanD Error Enable
EXE	16	Execution Error Enable
DDE	8	Device Dependent Error Enable
QRY	4	QueRry Error Enable
N.U.	2	Not used
OPC	1	Operation Complete Enable

Example(s)

*ESR? returns 33
where 33 = (bit CME and bit OPC)

See Also

*ESE
*ESE?

***IDN?**

Description	The intent of the *IDN? query is for the unique identification of devices over the system interface.
Syntax	*IDN?
Parameter(s)	None
Response Syntax	<Identification>
Response(s)	<p><i>Identification:</i></p> <p>The response data syntax for <Identification> is defined as an <ARBITRARY ASCII RESPONSE DATA> element.</p>

The response syntax for the *IDN? query, <Identification> is defined as an <ARBITRARY ASCII RESPONSE DATA> element. This implies that the *IDN? query should be the last <QUERY MESSAGE UNIT> in a <TERMINATED PROGRAM MESSAGE>.

The response is organized into four fields separated by commas. The field definitions are as follows:

Field 1 (Manufacturer): EXFO Inc.
Field 2 (Model): Instrument Model

IEEE 488.2 and Specific Command Reference

IEEE 488.2 Required Commands

***IDN?**

Field 3 (Serial number): ASCII character (0 if not available)

Field 4 (Firmware level): ASCII character (0 if not available)

ASCII character 0 represents a single ASCII-encoded byte with a value of 30 (48 decimal).

The presence of data in all fields is mandatory. If either field 3 or 4 is not available, the ASCII character 0 shall be returned for that field. A field may contain any 7-bit ASCII-encoded bytes in the range of 20 through 7E (32 through 126 decimal) except commas (2C, 44 decimal) and semicolons (3B, 59 decimal).

Example(s)

*IDN? returns EXFO Inc.,
FTB-2 Pro,125-2A55,1.0.1.97

Notes

The overall length of the *IDN? response is less than or equal to 72 characters.

***OPC**

Description	The *OPC command makes synchronization between the instrument and an external controller possible. The *OPC command causes the instrument to set bit 0 (Operation Complete) in the Standard Event Status Register to the TRUE (logic 1) state when the instrument completes all pending operations. Detection of the Operation Complete message can be accomplished by continuous polling of the Standard Event Status Register using the *ESR? common query command. However, using a service request eliminates the need to poll the Standard Event Status Register thereby freeing the controller to do other useful work.
Syntax	*OPC
Parameter(s)	None
See Also	*OPC? *WAI

*OPC?

Description	The *OPC? query makes possible the synchronization between the instrument and an external controller by reading the Output Queue or by waiting for a service request on the Message Available (MAV) bit in the Status Byte Register. The *OPC? query causes the instrument to place an ASCII character, 1, into its Output Queue when the device completes all pending operations. A consequence of this action is that the MAV bit in the Status Byte Register is set to state 1.
Syntax	*OPC?
Parameter(s)	None
Response Syntax	<Acknowledge>
Response(s)	<i>Acknowledge:</i> The response data syntax for <Acknowledge> is defined as a <NR1 NUMERIC RESPONSE DATA> element. The <Acknowledge> response is a single ASCII-encoded byte corresponding to 1. The receipt of an <Acknowledge> response indicates that all pending selected device operations have been completed.
Example(s)	*OPC? returns 1
See Also	*OPC *WAI

***RST**

Description

The *RST command performs a device reset. This command is the third reset level in a three-level reset strategy. The Reset command shall do the following:

- a) Sets the device-specific functions to a known state that is independent of the past-use history of the device.
- b) Forces the device into OCIS state (Operation complete Command Idle State).
- c) Forces the device into OQIS state (Operation complete Query Idle State).

The Reset command explicitly DOES NOT affect the following:

- a) The state of the Communication interface.
- b) The Output Queue.
- c) Any Event Enable Register setting, including the Standard Event Status Enable Register setting.
- d) Any Event Register setting, including the Standard Event Status Register settings.
- e) Calibration data that affects device specifications.
- f) The Service Request Enable Register setting.

Syntax

*RST

Parameter(s)

None

IEEE 488.2 and Specific Command Reference

IEEE 488.2 Required Commands

*SRE

Description

The *SRE command sets the Service Request Enable Register bits. See the contents of this register below. This register contains a mask value to enable the bits in the Status Byte Register.

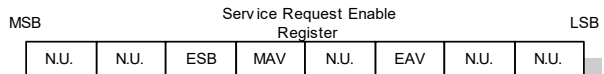

Syntax

*SRE<wsp> <RegisterValue>

Parameter(s)

RegisterValue:

The program data syntax for <RegisterValue> is defined as a <DECIMAL NUMERIC PROGRAM DATA> element.

The <RegisterValue> value ranges from 0 through 255.

The <RegisterValue>, expressed in base 2 (binary), represents the bit values of the Service Request Enable Register.

***SRE**

See the contents of this register below.

Bit	Weight	Meaning
N.U.	128	Not used
N.U.	64	Not used
ESB	32	Event Summary Bit Enable
MAV	16	Message AVailable Enable
N.U.	8	Not used
EAV	4	Error / Event AVailable Enable
N.U.	2	Not used
N.U.	1	Not used

A bit value of zero shall indicate a disabled condition.

Example(s)

*SRE 52
where 52 = (bit ESB, bit MAV and bit EAV)

See Also

*SRE?
*STB?

IEEE 488.2 and Specific Command Reference

IEEE 488.2 Required Commands

***SRE?**

Description

With the *SRE? query you can determine the current contents of the Service Request Enable Register. See the contents of this register below.

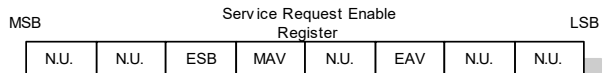

Bit	Weight	Meaning
N.U.	128	Not used
N.U.	64	Not used
ESB	32	Event Summary Bit Enable
MAV	16	Message AAvailable Enable
N.U.	8	Not used
EAV	4	Error / Event AAvailable Enable
N.U.	2	Not used
N.U.	1	Not used

Syntax

*SRE?

Parameter(s)

None

Response Syntax

<RegisterValue>

***SRE?**

Response(s)

RegisterValue:

The response data syntax for <RegisterValue> is defined as a <NR1 NUMERIC RESPONSE DATA> element.

The <RegisterValue> ranges from 0 through 255.

When converted to binary (base 2), the <RegisterValue> represents the current bit values of the Service Request Enable Register.

Example(s)

*SRE returns 32 (bit ESB)

See Also

*SRE
*STB?

IEEE 488.2 and Specific Command Reference

IEEE 488.2 Required Commands

*STB?

Description

With the *STB? query you can read the status byte and Master Summary Status bit. See the content of this register below.

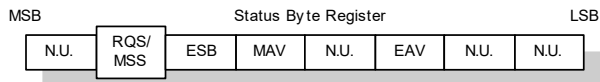
**Syntax**

*STB?

Parameter(s)

None

Response Syntax

<RegisterValue>

STB?*Response(s)***RegisterValue:*

The response data syntax for <RegisterValue> is defined as a <NR1 NUMERIC RESPONSE DATA> element.

The <RegisterValue> ranges from 0 through 255.

The <RegisterValue> value, expressed in base 2 (binary) represents the bit values of the Status Byte Register. See the contents of this register below.

Bit	Weight	Meaning
N.U.	128	Not used
RQS/ MSS	64	ReQuest Service (read by serial polling)/MaSter Summary bit (read by *STB?)
ESB	32	Event Summary Bit Enable
MAV	16	Message AVailable Enable
N.U.	8	Not used
EAV	4	Error / Event AVailable Enable
N.U.	2	Not used
N.U.	1	Not used

Example(s)

*STB? returns 68
where 68 = (bit MSS and bit EAV)

See Also

*SRE
*SRE?

IEEE 488.2 and Specific Command Reference

IEEE 488.2 Required Commands

*TST?	
Description	The *TST? query causes an internal self-test and places a response into the Output Queue indicating whether or not the device completed the self-test without any detected errors. Upon successful completion of *TST?, the device settings is restored to their values prior to the *TST?.
Syntax	*TST?
Parameter(s)	None
Response Syntax	<Result>
Response(s)	<p><i>Result:</i></p> <p>The response data syntax for <Result> is defined as a <NR1 NUMERIC RESPONSE DATA> element.</p> <p>The <Result> value ranges from -32767 through +32767.</p> <p>A <Result> with a value of zero indicates that the self-test has been completed without errors detected. A <Result> with a value not equal to zero indicates that the self-test was not completed or was completed with errors detected.</p>
Example(s)	*TST? returns 0 (self-test was completed with success)

***WAI**

Description	The *WAI command shall prevent the device from executing any further commands or queries until the no-operation-pending flag becomes TRUE.
Syntax	*WAI
Parameter(s)	None
Example(s)	*WAI
See Also	*OPC *OPC?

Specific Commands—Quick Reference

The table below contains a summary of the commands specific to your unit. These commands are fully explained on the following pages.

Command						Parameter(s)
FORMat	[DATA]					ASCIi PACKed[,<Length>]
	[DATA]?					
INSTRument	CATalog?					
	CATalog	FULL?				
SYSTem	DATE					<Year>,<Month>,<Day>
	DATE?					
	ERRor	[NEXT]?				
	TIME					<Hour>,<Minute>,<Seconds>
	TIME?					
	VERSIon?					

Specific Commands

:FORMat[:DATA]

Description

The FORMat[:DATA] command selects the data format and <Length>. The <Length> parameter is optional for all data format, its meaning is dependent on the data format selected.

If PACKed type is selected, the data is transferred in a <DEFINITE BLOCK RESPONSE DATA>. The ASCii-type data is automatically identified by its syntax. Therefore, in these cases, the FORMat subsystem is only necessary to determine the output format.

At *RST, ASCii is selected as the default data format and the <Length> is set to 0.

Syntax

:FORMat[:DATA] <wsp>ASCii|PACKed[, <Length>]

Parameter(s)

► *Type:*

The program data syntax for the first parameter is defined as a <CHARACTER PROGRAM DATA> element. The allowed <CHARACTER PROGRAM DATA> elements for this parameter are: ASCii|PACKed.

:FORMat[:DATA]

In ASCii format, the numeric data is transferred to ASCii bytes in <NR1 NUMERIC RESPONSE DATA>, <NR2 NUMERIC RESPONSE DATA> or <NR3 NUMERIC RESPONSE DATA> representation, as appropriate.

In PACKed format, data is transferred to a <DEFINITE BLOCK RESPONSE DATA>, in a manner specified in the device documentation.

► *Length:*

The program data syntax for <Length> is defined as a <DECIMAL NUMERIC PROGRAM DATA> element.

When ASCii data format is selected, the optional <Length> parameter specifies the number of significant digits to be returned. A <Length> value of zero indicates that the device selects the number of significant digits to be returned. When a <Length> of zero has been specified, the FORMat[:DATA]? query returns zero as its second parameter.

When the PACKed data format is selected, the optional parameter <Length> it not used.

Example(s)

FORM ASC
FORM ASC,6
FORM:DATA PACKED

See Also

FORMat[:DATA]?

:FORMat[:DATA]?

Description	<p>The FORMat[:DATA]? query returns the data format and the <Length>.</p> <p>At *RST, ASCii is selected as the default data format and the <Length> is set to 0.</p>
Syntax	:FORMat[:DATA]?
Parameter(s)	None
Response Syntax	<Type>,<Length>
Response(s)	<p>➤ <i>Type:</i></p> <p>The response data syntax for <Type> is defined as a <CHARACTER RESPONSE DATA> element.</p> <p>The ASCII <Type> is returned when numeric data is transferred to ASCII bytes in <NR1 NUMERIC RESPONSE DATA>, <NR2 NUMERIC RESPONSE DATA> or <NR3 NUMERIC RESPONSE DATA> representation, as appropriate.</p> <p>The PACKED <Type> is returned when data is transferred to a <DEFINITE BLOCK RESPONSE DATA>, as specified in the device documentation.</p> <p>➤ <i>Length:</i></p> <p>The response data syntax for <Length> is defined as a <NR1 NUMERIC RESPONSE DATA> element.</p>

:FORMat[:DATA]?

When the data is returned in ASCII, the <Length> is the number of significant digits to be returned. A <Length> value of zero indicates that the device selects the number of significant digits to be returned.

When the data is returned in PACKED <Type>, the <Length> is not used and always returns 0.

Example(s)

FORM? returns ASCII,6

FORM? returns PACKED,0

See Also

FORMat[:DATA]?

:INSTrument:CATalog?

Description	<p>The INSTrument:CATalog? query returns a comma-separated list of <STRING RESPONSE DATA>, which contains the names of all logical instruments and groups. If no logical instruments are defined, a single null <STRING RESPONSE DATA> is returned.</p> <p>This is not affected by a *RST command.</p>
Syntax	:INSTrument:CATalog?
Parameter(s)	None
Response Syntax	<Catalog>
Response(s)	<p><i>Catalog:</i></p> <p>The response data syntax for <Catalog> is defined as a <STRING RESPONSE DATA> element.</p> <p>The list of <STRING PROGRAM DATA> contains the names of all logical instruments and groups.</p>
Example(s)	INST:CAT? returns “FTB-5240BP Optical Spectrum Analyzer (1250nm-1650nm)”,”FTB-5240S Optical Spectrum Analyzer (1250nm-1650nm)”
See Also	INSTrument:CATalog:FULL?

:INSTrument:CATalog:FULL?

Description	<p>The INSTrument:CATalog:FULL? returns a list of <STRING RESPONSE DATA> - <NR1 NUMERIC RESPONSE DATA> pairs. The <STRING RESPONSE DATA> contains the name of the logical instrument. The immediately following <NR1 NUMERIC RESPONSE DATA> formatted number is its associated logical instrument number. All response data elements are separated by commas. If no logical instrument is defined, a null <STRING RESPONSE DATA> value followed by a zero is returned.</p> <p>This is not affected by a *RST command.</p>
Syntax	:INSTrument:CATalog:FULL?
Parameter(s)	None
Response Syntax	<Catalog>
Response(s)	<p><i>Catalog:</i></p> <p>The response data syntax for <Catalog> is defined as a <STRING RESPONSE DATA> element.</p> <p>The list of <STRING RESPONSE DATA> contains the names of all logical instruments and groups. The immediately following <NR1 NUMERIC RESPONSE DATA> formatted number is its associated logical instrument number.</p>
Example(s)	<p>INST:CAT:FULL? returns "FTB-5240BP Optical Spectrum Analyzer (1250nm-1650nm)",1,"FTB-5240S Optical Spectrum Analyzer (1250nm-1650nm)",2</p>
See Also	INSTrument:CATalog?.

:SYSTem:DATE

Description	<p>The SYSTem:DATE command is used to set the device's internal calendar.</p> <p>This is not affected by a *RST command.</p>
Syntax	:SYSTem:DATE<wsp><Year>,<Month>,<Day> >
Parameter(s)	<p>➤ <i>Year:</i></p> <p>The program data syntax for <Year> is defined as a <DECIMAL NUMERIC PROGRAM DATA> element.</p> <p>The <Year> is rounded to the nearest integer. Its range is limited by the capability of the device. The year shall be entered as a four-digit number, including century and millennium information.</p> <p>➤ <i>Month:</i></p> <p>The program data syntax for <Month> is defined as a <DECIMAL NUMERIC PROGRAM DATA> element.</p> <p>The <Month> is rounded to the nearest integer. Its range is 1 to 12 inclusive. The number 1 corresponds to January, 2 to February, and so on.</p>

:SYSTem:DATE

➤ *Day:*

The program data syntax for <Day> is defined as a <DECIMAL NUMERIC PROGRAM DATA> element.

The <Day> is rounded to the nearest integer. It ranges from 1 to the number of days in the month from the previous parameter. This command keeps track of the number of days in each month, accounting for leap years through the range of years that it accepts.

Example(s)

SYST:DATE 2014,07,29

See Also

SYSTem:DATE?

:SYSTem:DATE?

Description	The SYSTem:DATE query returns the instrument's internal calendar. This is not affected by a *RST command.
Syntax	:SYSTem:DATE?
Parameter(s)	None
Response Syntax	<Year>,<Month>,<Day>

:SYSTem:DATE?

Response(s)

► *Year:*

The response data syntax for <Year> is defined as a <NR1 NUMERIC RESPONSE DATA> element.

The <Year> is a four-digit number, including century and millennium information.

► *Month:*

The response data syntax for <Month> is defined as a <NR1 NUMERIC RESPONSE DATA> element.

The <Month> ranges from 1 to 12, inclusively. The number 1 corresponds to January, 2 to February, and so on.

► *Day:*

The response data syntax for <Day> is defined as a <NR1 NUMERIC RESPONSE DATA> element.

The <Day> ranges from 1 to the number of days in the month from the previous field. This command keeps track of the number of days in each month, accounting for leap years through the range of years that it accepts.

Example(s)

SYST:DATE? returns 2017,07,29

See Also

SYSTem:DATE

:SYSTem:ERRor[:NEXT]?

Description	<p>The SYSTem:ERRor[:NEXT]? queries the error/event queue for the next item and removes it from the queue. The response message consists of two fields separated by commas <Code>,<Description[,Info]>.</p> <p>SYSTem:ERRor[:NEXT]? is a query only and, therefore, does not have an associated *RST state.</p>
Syntax	:SYSTem:ERRor[:NEXT]?
Parameter(s)	None
Response Syntax	<Code>,<Description[,Info]>
Response(s)	<p>► <i>Code:</i></p> <p>The response data syntax for <Code> is defined as a <NR1 NUMERIC RESPONSE DATA> element.</p> <p>The <Code> is a unique integer in the range [-32768, 32767]. All positive numbers are instrument-dependent. All negative numbers are reserved by the SCPI standard with certain standard error/event codes described in an appendix of this document. The zero value is also used to indicate that no error or event has occurred.</p> <p>► <i>Description[,Info]:</i></p> <p>The response data syntax for <Description[,Info]> is defined as a <STRING RESPONSE DATA> element.</p>

:SYSTem:ERRor[:NEXT]?

The <Description[,Info]> parameter of the full response is a quoted string containing a description followed by information text [,Info]. Each <Code> has a unique and fixed <Description> associated with it. The <Date> and <Time> are appended to the [,info] separated by a semi-colon using the following format:

<Date><wsp><Time> where

<Date> = Year/Month/Day

<Time> = Hour,Minute,Second (24 hour time)

The maximum length of <Description[,Info]> is 255 characters. For standard defined error/event <Codes>, the <Description> is sent exactly as indicated in the appendix of this document.

Example(s)

SYST:ERR:NEXT? returns -222,"Data out of range"

SYST:ERR:NEXT? returns -222,"Data out of range,instrument monomodule 5240S, 2014/07/29 14:56:16.259"

:SYSTem:TIME

Description	<p>This device has an internal clock and implements the SYSTem:TIME command to set the clock time over the interface.</p> <p>This is not affected by a *RST command.</p>
Syntax	:SYSTem:TIME<wsp><Hour>,<Minute>,<Seconds>
Parameter(s)	<p>➤ <i>Hour:</i></p> <p>The program data syntax for <Hour> is defined as a <DECIMAL NUMERIC PROGRAM DATA> element.</p> <p>The <Hour> is always rounded to the nearest integer. It ranges from 0 to 23 inclusively. The device accepts hour information in 24-hour format.</p> <p>➤ <i>Minute:</i></p> <p>The program data syntax for <Minute> is defined as a <DECIMAL NUMERIC PROGRAM DATA> element.</p> <p>The <Minute> is always rounded to the nearest integer. It ranges from 0 to 59 inclusively.</p>

:SYSTem:TIME

➤ *Seconds:*

The program data syntax for <Seconds> is defined as a <DECIMAL NUMERIC PROGRAM DATA> element.

The <Second> is rounded to the resolution of the clock. It ranges from 0 to 60. A value of 60 is allowed since rounding may cause a number greater than 59.5 to be rounded to 60. When this element is rounded to 60 it shall be set to 0 and the minute value incremented. Any other carries shall be rippled through the date.

Example(s)

SYST:TIME 12,47,29

See Also

SYSTem:TIME?

:SYSTem:TIME?

Description	This device has an internal clock and implements the SYSTem:DATE? query to get the clock time over the interface. This is not affected by a *RST command.
Syntax	:SYSTem:TIME?
Parameter(s)	None
Response Syntax	<Hour>,<Minute>,<Second>

:SYSTem:TIME?

Response(s)

► *Hour:*

The response data syntax for <Hour> is defined as a <NR1 NUMERIC RESPONSE DATA> element.

The <Hour> ranges from 0 to 23. The instruments returns hour information in 24-hour format.

► *Minute:*

The response data syntax for <Minute> is defined as a <NR1 NUMERIC RESPONSE DATA> element.

The <Minute> ranges from 0 to 59.

► *Second:*

The response data syntax for <Second> is defined as a <NR1 NUMERIC RESPONSE DATA> element.

The <Second> ranges from 0 to 59. The resolution of the clock is the second.

Example(s)

SYST:TIME? returns 16,55,38

See Also

SYSTem:TIME

:SYSTem:VERSion?

Description	<p>The SYSTem:VERSion? query returns a value corresponding to the SCPI version number to which the device complies.</p> <p>The SYSTem:VERSion? is a query only and, therefore, does not have an associated *RST state.</p>
Syntax	:SYSTem:VERSion?
Parameter(s)	None
Response Syntax	<Version>
Response(s)	<p><i>Version:</i></p> <p>The response data syntax for <Version> is defined as a <NR2 NUMERIC RESPONSE DATA> element.</p> <p>The <Version> is shown in the form Year.Revision, where Year represents the year-version (that is 1990) and Revision represents an approved revision number for that year. If no approved revisions are claimed, then this extension is 0.</p>
Example(s)	SYSTem:VERSion? returns 1999.0 (no approved revisions are claimed)

C SCPI-Based Errors

Error Number	Description	Probable Cause
-100	“Command error”	This is the generic syntax error for devices that cannot detect more specific errors. This code indicates only that a Command Error as defined in IEEE 488.2, 11.5.1.1.4 has occurred.
-101	“Invalid character”	A syntactic element contains a character which is invalid for that type; for example, a header containing an ampersand, SETUP&. This error might be used in place of errors -114, -121, -141, and perhaps some others.
-102	“Syntax error”	An unrecognized command or data type was encountered; for example, a string was received when the device does not accept strings.
-103	“Invalid separator”	The parser was expecting a separator and encountered an illegal character; for example, the semicolon was omitted after a program message unit, *EMC 1:CH1:VOLTS 5.
-104	“Data type error”	The parser recognized a data element different than one allowed; for example, numeric or string data was expected but block data was encountered.
-105	“GET not allowed”	A Group Execute Trigger was received within a program message (see IEEE 488.2, 7.7).
-108	“Parameter not allowed”	More parameters were received than expected for the header; for example, the *EMC common command only accepts one parameter, so receiving *EMC 0,1 is not allowed.
-109	“Missing parameter”	Fewer parameters were received than required for the header; for example, the *EMC common command requires one parameter, so receiving *EMC is not allowed.

SCPI-Based Errors

Error Number	Description	Probable Cause
-110	“Command header error”	An error was detected in the header. This error message should be used when the device cannot detect the more specific errors described for errors -111 through -119.
-111	“Header separator error”	A character which is not a legal header separator was encountered while parsing the header; for example, no white space followed the header, thus *GMC"MACRO" is an error.
-112	“Program mnemonic too long”	The header contains more than twelve characters (see IEEE 488.2, 7.6.1.4.1).
-113	“Undefined header”	The header is syntactically correct, but it is undefined for this specific device; for example, *XYZ is not defined for any device.
-114	“Header suffix out of range”	The value of a numeric suffix attached to a program mnemonic (see IEEE 488.2, Syntax and Style section 6.2.5.2) makes the header invalid.
-115	“Unexpected number of parameters”	The number of parameters received does not correspond to the number of parameters expected. This is typically due to an inconsistency with the number of instruments in the selected group (see section on INSTRUMENT:DEFine:GROup).
-120	“Numeric data error”	This error, as well as errors -121 through -129, are generated when parsing a data element which appears to be numeric, including the non-decimal numeric types. This particular error message should be used if the device cannot detect a more specific error.
-121	“Invalid character in number”	An invalid character for the data type being parsed was encountered; for example, an alpha in a decimal numeric or a "9" in octal data.

Error Number	Description	Probable Cause
-123	“Exponent too large”	The magnitude of the exponent was larger than 32000 (see IEEE 488.2, 7.7.2.4.1).
-124	“Too many digits”	The mantissa of a decimal numeric data element contained more than 255 digits excluding leading zeros (see IEEE 488.2, 7.7.2.4.1).
-128	“Numeric data not allowed”	A legal numeric data element was received, but the device does not accept one in this position for the header.
-130	“Suffix error”	This error, as well as errors -131 through -139, are generated when parsing a suffix. This particular error message should be used if the device cannot detect a more specific error.
-131	“Invalid suffix”	The suffix does not follow the syntax described in IEEE 488.2, 7.7.3.2, or the suffix is inappropriate for this device.
-134	“Suffix too long”	The suffix contained more than 12 characters (see IEEE 488.2, 7.7.3.4).
-138	“Suffix not allowed”	A suffix was encountered after a numeric element which does not allow suffixes.
-140	“Character data error”	This error, as well as errors -141 through -149, are generated when parsing a character data element. This particular error message should be used if the device cannot detect a more specific error.
-141	“Invalid character data”	Either the character data element contains an invalid character or the particular element received is not valid for the header.
-144	“Character data too long”	The character data element contains more than twelve characters (see IEEE 488.2, 7.7.1.4).
-148	“Character data not allowed”	A legal character data element was encountered where prohibited by the device.

SCPI-Based Errors

Error Number	Description	Probable Cause
-150	“String data error”	This error, as well as errors -151 through -159, are generated when parsing a string data element. This particular error message should be used if the device cannot detect a more specific error.
-151	“Invalid string data”	A string data element was expected, but was invalid for some reason (see IEEE 488.2, 7.7.5.2); for example, an END message was received before the terminal quote character.
-158	“String data not allowed”	A string data element was encountered but was not allowed by the device at this point in parsing.
-160	“Block data error”	This error, as well as errors -161 through -169, are generated when parsing a block data element. This particular error message should be used if the device cannot detect a more specific error.
-161	“Invalid block data”	A block data element was expected, but was invalid for some reason (see IEEE 488.2, 7.7.6.2); for example, an END message was received before the length was satisfied.
-168	“Block data not allowed”	A legal block data element was encountered but was not allowed by the device at this point in parsing.
-170	“Expression error”	This error, as well as errors -171 through -179, are generated when parsing an expression data element. This particular error message should be used if the device cannot detect a more specific error.
-171	“Invalid expression”	The expression data element was invalid (see IEEE 488.2, 7.7.7.2); for example, unmatched parentheses or an illegal character.
-178	“Expression data not allowed”	A legal expression data was encountered but was not allowed by the device at this point in parsing.

Error Number	Description	Probable Cause
-180	"Macro error"	This error, as well as errors -181 through -189, are generated when defining a macro or executing a macro. This particular error message should be used if the device cannot detect a more specific error.
-181	"Invalid outside macro definition"	Indicates that a macro parameter placeholder (\$<number>) was encountered outside of a macro definition.
-183	"Invalid inside macro definition"	Indicates that the program message unit sequence, sent with a *DDT or *DMC command, is syntactically invalid (see IEEE 488.2, 10.7.6.3).
-184	"Macro parameter error"	Indicates that a command inside the macro definition had the wrong number or type of parameters.
-200	"Execution error"	This is the generic syntax error for devices that cannot detect more specific errors. This code indicates only that an Execution Error as defined in IEEE 488.2, 11.5.1.1.5 has occurred.
-201	"Invalid while in local"	Indicates that a command is not executable while the device is in local due to a hard local control (see IEEE 488.2, 5.6.1.5); for example, a device with a rotary switch receives a message which would change the switches state, but the device is in local so the message can not be executed.
-202	"Settings lost due to rtl"	Indicates that a setting associated with a hard local control (see IEEE 488.2, 5.6.1.5) was lost when the device changed to LOCS from REMS or to LWLS from RWLS.
-203	"Command protected"	Indicates that a legal password-protected program command or query could not be executed because the command was disabled.

SCPI-Based Errors

Error Number	Description	Probable Cause
-210	“Trigger error”	-----
-211	“Trigger ignored”	Indicates that a GET, *TRG, or triggering signal was received and recognized by the device but was ignored because of device timing considerations; for example, the device was not ready to respond. Note: a DT0 device always ignores GET and treats *TRG as a Command Error.
-212	“Arm ignored”	Indicates that an arming signal was received and recognized by the device but was ignored.
-213	“Init ignored”	Indicates that a request for a measurement initiation was ignored as another measurement was already in progress.
-214	“Trigger deadlock”	Indicates that the trigger source for the initiation of a measurement is set to GET and subsequent measurement query is received. The measurement cannot be started until a GET is received, but the GET would cause an INTERRUPTED error.
-215	“Arm deadlock”	Indicates that the arm source for the initiation of a measurement is set to GET and subsequent measurement query is received. The measurement cannot be started until a GET is received, but the GET would cause an INTERRUPTED error.
-220	“Parameter error”	Indicates that a program data element related error occurred. This error message should be used when the device cannot detect the more specific errors described for errors -221 through -229.
-221	“Settings conflict”	Indicates that a legal program data element was parsed but could not be executed due to the current device state (see IEEE 488.2, 6.4.5.3 and 11.5.1.1.5).

Error Number	Description	Probable Cause
-222	“Data out of range”	Indicates that a legal program data element was parsed but could not be executed because the interpreted value was outside the legal range as defined by the device (see IEEE 488.2, 11.5.1.1.5).
-223	“Too much data”	Indicates that a legal program data element of block, expression, or string type was received that contained more data than the device could handle due to memory or related device-specific requirements.
-224	“Illegal parameter value”	Used where exact value, from a list of possible, was expected.
-225	“Out of memory”	The device has insufficient memory to perform the requested operation.
-226	“Lists not same length”	Attempted to use LIST structure having individual LIST's of unequal lengths.
-230	“Data corrupt or stale”	Possibly invalid data; new reading started but not completed since last access.
-231	“Data questionable”	Indicates that measurement accuracy is suspect.
-232	“Invalid format”	Indicates that a legal program data element was parsed but could not be executed because the data format or structure is inappropriate. For example when loading memory tables or when sending a SYSTem:SET parameter from an unknown instrument.

SCPI-Based Errors

Error Number	Description	Probable Cause
-233	“Invalid version”	Indicates that a legal program data element was parsed but could not be executed because the version of the data is incorrect to the device. This particular error should be used when file or block data formats are recognized by the instrument but cannot be executed for reasons of version incompatibility. For example, a not supported file version, a not supported instrument version
-240	“Hardware error”	Indicates that a legal program command or query could not be executed because of a hardware problem in the device. Definition of what constitutes a hardware problem is completely device-specific. This error message should be used when the device cannot detect the more specific errors described for errors -241 through -249.
-241	“Hardware missing”	Indicates that a legal program command or query could not be executed because of missing device hardware; for example, an option was not installed. Definition of what constitutes missing hardware is completely device-specific.
-250	“Mass storage error”	Indicates that a mass storage error occurred. This error message should be used when the device cannot detect the more specific errors described for errors -251 through -259.
-251	“Missing mass storage”	Indicates that a legal program command or query could not be executed because of missing mass storage; for example, an option that was not installed. Definition of what constitutes missing mass storage is device-specific.
-252	“Missing media”	Indicates that a legal program command or query could not be executed because of a missing media; for example, no disk. The definition of what constitutes missing media is device-specific.

Error Number	Description	Probable Cause
-253	"Corrupt media"	Indicates that a legal program command or query could not be executed because of corrupt media; for example, bad disk or wrong format. The definition of what constitutes corrupt media is device-specific.
-254	"Media full"	Indicates that a legal program command or query could not be executed because the media was full; for example, there is no room on the disk. The definition of what constitutes a full media is device-specific.
-255	"Directory full"	Indicates that a legal program command or query could not be executed because the media directory was full. The definition of what constitutes a full media directory is device-specific.
-256	"File name not found"	Indicates that a legal program command or query could not be executed because the file name on the device media was not found; for example, an attempt was made to read or copy a nonexistent file. The definition of what constitutes a file not being found is device-specific.
-257	"File name error"	Indicates that a legal program command or query could not be executed because the file name on the device media was in error; for example, an attempt was made to copy to a duplicate file name. The definition of what constitutes a file name error is device-specific.
-258	"Media protected"	Indicates that a legal program command or query could not be executed because the media was protected; for example, the write-protect tab on a disk was present. The definition of what constitutes protected media is device-specific.

SCPI-Based Errors

Error Number	Description	Probable Cause
-260	“Expression error”	[Indicates that a expression program data element related error occurred. This error message should be used when the device cannot detect the more specific errors described for errors -261 through -269.]
-261	“Math error in expression”	[Indicates that a syntactically legal expression program data element could not be executed due to a math error; for example, a divide-by-zero was attempted. The definition of math error is device-specific.]
-270	“Macro error”	[Indicates that a macro-related execution error occurred. This error message should be used when the device cannot detect the more specific errors described for errors -271 through -279.]
-271	“Macro syntax error”	[Indicates that a syntactically legal macro program data sequence, according to IEEE 488.2, 10.7.2, could not be executed due to a syntax error within the macro definition (see IEEE 488.2, 10.7.6.3).]
-272	“Macro execution error”	[Indicates that a syntactically legal macro program data sequence could not be executed due to some error in the macro definition (see IEEE 488.2, 10.7.6.3).]
-273	“Illegal macro label”	[Indicates that the macro label defined in the *DMC command was a legal string syntax, but could not be accepted by the device (see IEEE 488.2, 10.7.3 and 10.7.6.2); for example, the label was too long, the same as a common command header, or contained invalid header syntax.]
-274	“Macro parameter error”	[Indicates that the macro definition improperly used a macro parameter placeholder (see IEEE 488.2, 10.7.3).]

Error Number	Description	Probable Cause
-275	“Macro definition too long”	[Indicates that a syntactically legal macro program data sequence could not be executed because the string or block contents were too long for the device to handle (see IEEE 488.2, 10.7.6.1).]
-276	“Macro recursion error”	[Indicates that a syntactically legal macro program data sequence could not be executed because the device found it to be recursive (see IEEE 488.2, 10.7.6.6).]
-277	“Macro redefinition not allowed”	[Indicates that a syntactically legal macro label in the *DMC command could not be executed because the macro label was already defined (see IEEE 488.2, 10.7.6.4).]
-278	“Macro header not found”	[Indicates that a syntactically legal macro label in the *GMC? query could not be executed because the header was not previously defined.]
-280	“Program error”	[Indicates that a downloaded program-related execution error occurred. This error message should be used when the device cannot detect the more specific errors described for errors -281 through -289. A downloaded program is used to add algorithmic capability to a device. The syntax used in the program and the mechanism for downloading a program is device-specific.]
-281	“Cannot create program”	[Indicates that an attempt to create a program was unsuccessful. A reason for the failure might include not enough memory.]
-282	“Illegal program name”	[The name used to reference a program was invalid; for example, redefining an existing program, deleting a nonexistent program, or in general, referencing a nonexistent program.]
-283	“Illegal variable name”	[An attempt was made to reference a nonexistent variable in a program.]

SCPI-Based Errors

Error Number	Description	Probable Cause
-284	“Program currently running”	[Certain operations dealing with programs may be illegal while the program is running; for example, deleting a running program might not be possible.]
-285	“Program syntax error”	[Indicates that a syntax error appears in a downloaded program. The syntax used when parsing the downloaded program is device-specific.]
-286	“Program runtime error”	-----
-290	“Memory use error”	[Indicates that a user request has directly or indirectly caused an error related to memory or <data_handle>, this is not the same as “bad” memory.]
-291	“Out of memory”	-----
-292	“Referenced name does not exist”	-----
-293	“Referenced name already exist”	-----
-294	“Incompatible type”	[Indicates that the type or structure of a memory item is inadequate]
-300	“Device-specific error”	[This is the generic device-dependent error for devices that cannot detect more specific errors. This code indicates only that a Device-Dependent Error as defined in IEEE 488.2, 11.5.1.1.6 has occurred.]
-310	“System error”	[Indicates that some error, termed "system error" by the device, has occurred. This code is device-dependent.]
-311	“Memory error”	[Indicates some physical fault in the device's memory, such as parity error.]

Error Number	Description	Probable Cause
-312	“PUD memory lost”	[Indicates that the protected user data saved by the *PUD command has been lost.]
-313	“Calibration memory lost”	[Indicates that nonvolatile calibration data used by the *CAL? command has been lost.]
-314	“Save/Recall memory lost”	[Indicates that the nonvolatile data saved by the *SAV? command has been lost.]
-315	“Configuration memory lost”	[Indicates that nonvolatile configuration data saved by the device has been lost. The meaning of this error is device-specific.]
-320	“Storage fault”	[Indicates that the firmware detected a fault when using data storage. This error is not an indication of physical damage or failure of any mass storage element.]
-321	“Out of memory”	[An internal operation needed more memory than was available.]
-330	“Self-test failed”	-----
-340	“Calibration failed”	-----
-350	“Queue overflow”	[A specific code entered into the queue in lieu of the code that caused the error. This code indicates that there is no room in the queue and an error occurred but was not recorded.]
-360	“Communication error”	[This is the generic communication error for devices that cannot detect the more specific errors described for errors -361 through -363.]
-361	“Parity error in program message”	[Parity bit not correct when data received for example, on a serial port.]
-362	“Framing error in program message”	[A stop bit was not detected when data was received for example, on a serial port (for example, a baud rate mismatch).]

SCPI-Based Errors

Error Number	Description	Probable Cause
-363	“Input buffer overrun”	[Software or hardware input buffer on serial port overflows with data caused by improper or nonexistent pacing.]
-365	“Time out error”	[This is a generic device-dependent error.]
-400	“Query error”	[This is the generic query error for devices that cannot detect more specific errors. This code indicates only that a Query Error as defined in IEEE 488.2, 11.5.1.1.7 and 6.3 has occurred.]
-410	“Query INTERRUPTED”	[Indicates that a condition causing an INTERRUPTED Query error occurred (see IEEE 488.2, 6.3.2.3); for example, a query followed by DAB or GET before a response was completely sent.]
-420	“Query UNTERMINATED”	[Indicates that a condition causing an UNTERMINATED Query error occurred (see IEEE 488.2, 6.3.2.2); for example, the device was addressed to talk and an incomplete program message was received.]
-430	“Query DEADLOCKED”	[Indicates that a condition causing an DEADLOCKED Query error occurred (see IEEE 488.2, 6.3.1.7); for example, both input buffer and output buffer are full and the device cannot continue.]
-440	“Query UNTERMINATED after indefinite response”	[Indicates that a query was received in the same program message after an query requesting an indefinite response was executed (see IEEE 488.2, 6.5.7.5).]
-500	“Power on”	[The instrument has detected an off to on transition in its power supply.]
-600	“User request”	[The instrument has detected the activation of a user request local control.]

Error Number	Description	Probable Cause
-700	"Request control"	[The instrument requested to become the active IEEE 488.1 controller-in-charge.]
-800	"Operation complete"	[The instrument has completed all selected pending operations in accordance with the IEEE 488.2, 12.5.2 synchronization protocol.]

D *COM Properties and Events*

Your unit also provides objects based on Microsoft Component Object Model (COM). COM defines a common way to access and create software components and services.

COM promotes the integration and the reuse of software components, as well as interoperability. In order to interoperate, components developed in different languages must adhere to a binary structure specified by Microsoft.

OLE and ActiveX are based on COM. Many programming languages can create and use COM components.

You can build your own programs using the provided properties and events via the `IcSCPIAccess` interface (available on your unit). For information on how to configure your unit for DCOM control, see *Configuring DCOM Access to Your Unit* on page 243.

ActiveX (COM/DCOM)—Quick Reference

The following diagram illustrates the different properties and events available.

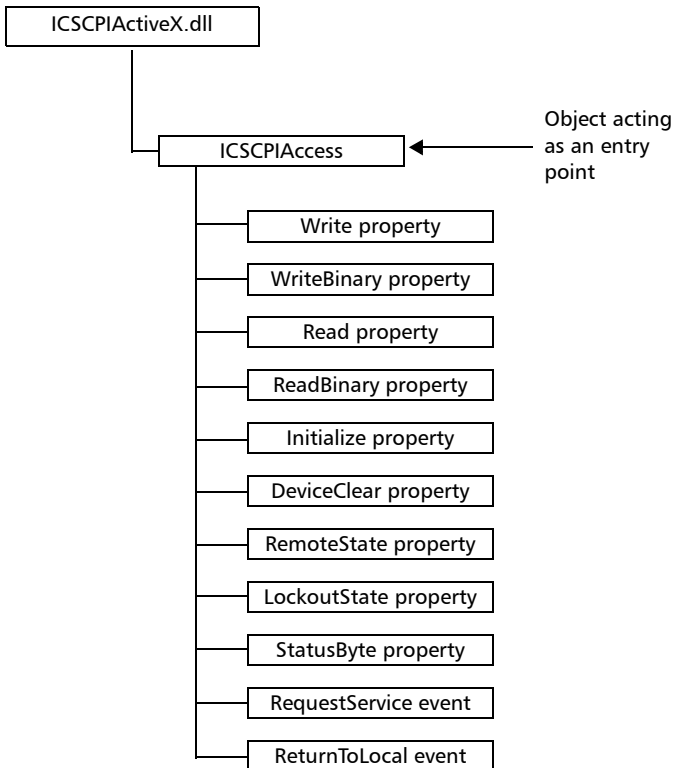

These properties and events are fully explained in the following pages.

Properties

Write

Description	With this method you can send a program message (single command or compound of commands) to the device input buffer.
Syntax	object. <i>Write</i> (<i>Message</i>)
Parameter(s)	<i>Message</i> : Required. A string value corresponding to the program message to be sent.
Possible error(s)	<i>Timeout</i> : This error will occur if the operation could not be completed within the allowed delay. For information on timeout setting, see <i>Initialize</i> on page 465.

WriteBinary

Description	With this method you can send a program message (single command or compound of commands) as an array of bytes into the device input buffer.
Syntax	<code>object.Write (BinaryArray)</code>
Parameter(s)	<i>BinaryArray</i> : Required. An array of bytes corresponding to the program message to be sent.
Notes	Use this method instead of the <i>Write</i> method if you need to send commands in binary (COM is UNICODE).
Possible error(s)	<i>Timeout</i> : This error will occur if the operation could not be completed within the allowed delay. For information on timeout setting, see <i>Initialize</i> on page 465.



IMPORTANT

Before you retrieve data with the *Read* or *ReadBinary* methods, you must specify the format in which the information must be returned. Details on how to correctly set the format can be found below.

Read

Description	With this method you can retrieve all the data from the device output queue in a UNICODE format.
Syntax	<code>object.Read</code>
Parameter(s)	None.
Response(s)	A string value (in UNICODE format).
Notes	<p>This method must be used in conjunction with the <i>Write</i> method. Always ensure that a query has been previously sent before attempting to read a response from the output queue.</p> <p>To properly set the data format, send the following command (using the <i>Write</i> method): FORM:DATA<wsp>ASCII <number_of_digits> where <number_of_digits> corresponds to the number of digits after the decimal point that you require.</p> <p>Remember that the retrieved data will have to be converted to a numeric format before you can use it in calculations, for example.</p>
Possible error(s)	<p><i>Timeout</i>: This error will occur if the allowed delay has expired before the preceding <i>Write</i> operation could send a response to the output queue. For information on timeout setting, see <i>Initialize</i> on page 465.</p> <p><i>QueryUnterminated</i>: This error will occur if the output queue is empty (for example, no query has been made previously).</p>

ReadBinary

Description	With this method you can retrieve data from the device output queue in a binary format.
Syntax	<code>object.ReadBinary</code>
Parameter(s)	None.
Response(s)	An array of bytes.
Notes	<p>This method must be used in conjunction with the <i>Write</i> method. Always ensure that a query has been previously sent before attempting to read a response from the output queue.</p> <p>To properly set the data format, send the following command (using the <i>Write</i> method): FORM:DATA<wsp>PACKED</p> <p>The retrieved data <i>does not</i> need to be converted to a numeric format before you can use it in calculations, for example.</p> <p>To help you know the actual length of the retrieved data, it has the following structure:</p> <ul style="list-style-type: none">➤ The first byte contains the # character.➤ The byte that immediately follows contains the number of subsequent bytes that you have to check to know the total length.

ReadBinary

For example, if you receive this response (here, values are expressed in decimal instead of binary for easier readability):

```
# 2 1 3 7 5 8 9 2 ...
```

The byte that immediately follows the # contains 2, which means that you have to read the two following bytes to know the length (in bytes) of the retrieved data. The bytes indicate 1 and 3. The length will then be 13 bytes. The actual response will begin at byte number 5, in this case.

Possible error(s)

Timeout: This error will occur if the allowed delay has expired before the preceding *Write* operation could send a response to the output queue. For information on timeout setting, see *Initialize* on page 465.

QueryUnterminated: This error will occur if the output queue is empty (for example, no query has been made previously).

Initialize

Description

With this method you can configure the timeout value that is, the allowed delay for Read and Write operations, in milliseconds.

Syntax

```
object.Initialize(Timeout)
```

Parameter(s)

Timeout: Required. A numeric value corresponding to the delay in milliseconds.

Notes

If the *Initialize* method is not invoked, the default value is 10 000 milliseconds.

COM Properties and Events

Properties

DeviceClear	
Description	This method performs a <i>Device Clear</i> operation as specified in the IEEE 488.1 standard.
Syntax	<code>object.DeviceClear</code>
Parameter(s)	None.

RemoteState	
Description	This property returns or sets the device's remote state.
Syntax	<code>object.RemoteState</code> (to retrieve the state) <code>object.RemoteState=State</code> (to set the state) <i>State</i> : a Boolean value corresponding to: True: Remote False: Local
Parameter(s)	None.
Response(s)	If the property is used to get the device's remote state, the property will return a Boolean value.
Access	Get/Set

LockoutState

Description	This property returns or sets the device's lockout state.
Syntax	<p>object.<i>LockoutState</i> (to retrieve the state)</p> <p>object.<i>LockoutState</i>=<i>State</i> (to set the state)</p> <p><i>State</i>: a Boolean value corresponding to:</p> <p> True: Lockout</p> <p> False: No lockout</p>
Parameter(s)	None.
Response(s)	If the property is used to get the device's lockout state, the property will return a Boolean value.
Access	Get/Set

StatusByte

Description	This read-only property returns the device's status byte. Refer to IEEE 488.2 standard for status byte description.
Syntax	object. <i>StatusByte</i>
Parameter(s)	None.
Response(s)	A value corresponding to the device's status byte.
Notes	This property can be used in conjunction with <i>RequestService</i> event (see <i>RequestService</i> on page 468) to find out why the device caused a Service Request (SRQ).
Access	Get

Events

RequestService	
Description	This event is triggered whenever the device causes a Service Request (SRQ).
Parameter(s)	None.
Notes	<p>It is the user's responsibility to configure the different registers (*SRE, *ESE) as stated in the IEEE 488.2 standard to receive SRQ.</p> <p>When used in conjunction with <i>StatusByte</i> property (see <i>StatusByte</i> on page 467), this event allows you to determine the cause of the SRQ.</p>

ReturnToLocal	
Description	This event is triggered when the user presses the Local button from the controller's front panel when the device is in Remote state.
Parameter(s)	None.

E **Communicating Through TCP/IP Over Telnet**

The EXFO Instrument Control provides SCPI automation or remote control over Telnet through TCP/IP as a Windows Service that continuously listens to a port from a Telnet server (FTB/IQS/LTB) on which modules to be tested are connected.

There are two types of commands that can be sent over Telnet: SCPI commands and internal protocol commands of the TCP/IP over Telnet service. The internal commands allow you to perform certain actions such as send SCPI commands as a script instead of one by one, force the disconnection of an active session, view the status of modules and of connected clients, etc.

Executing SCPI Commands Over Telnet

You can remotely control the modules by executing SCPI commands through TCP/IP over Telnet. The commands are sent remotely from the Telnet client (on a computer) to the Telnet server (in this case, the IQS, FTB, or LTB unit).

You can connect from a remote Windows client or a Linux (or Unix) remote client.

Note: *The Telnet client is available on the FTB-500, FTB-2 running Windows 10, FTB-2 Pro, FTB-4 Pro, LTB-8, and IQS-600 controller if you intend to use these units as computers to connect to a Telnet server. However, on an FTB-2 running Windows Embedded 8 Standard, or on an LTB-1, the Telnet client is not available. You must use the PuTTY application to establish communication.*

Before being able to send SCPI commands, you must first establish a connection to the Telnet service.

Communicating Through TCP/IP Over Telnet

Executing SCPI Commands Over Telnet

To execute SCPI commands over Telnet from a remote Windows client:

- 1.** Establish a connection to the Telnet service as follows:
 - 1a.** From your computer, start Windows.
 - 1b.** On the taskbar, click **Start** (Start button () under Windows 8.1 and Windows 10) and select **Run**.

Note: Depending on the operating system, Run can sometimes be found under Windows System.

- 1c.** In the **Open** box, type *telnet*, and then click **OK**.

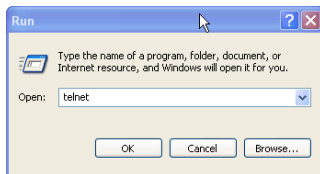

Note: If you receive an error message, it probably means that the Telnet client is not already activated on your computer. In this case, in the **Open** box, type `pkgmgr /iu:TelnetClient`, and then click **OK** to enable the client. Once it is done, perform step 3 again.

Communicating Through TCP/IP Over Telnet

Executing SCPI Commands Over Telnet

- 1d.** In the displayed Telnet editor window, type the `OPEN <IP_ADDRESS_OF_TELNET_SERVER> <PORT>` command to connect to the TCP/IP Telnet Service.

Example: `open 10.192.2.45 5024`

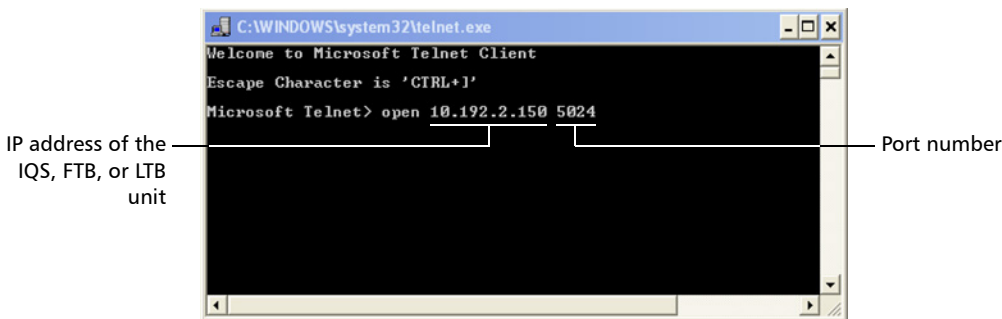

Note: Port 5024 is designated for sending SCPI commands in the Telnet protocol.

- 1e.** Press ENTER to establish a connection with the Service.

Once the connection is established, the `READY>` prompt is displayed in the Telnet editor window.

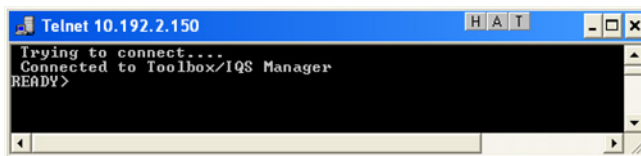

Note: If the connection cannot be established, the *Connection to host lost* message is displayed instead.

Communicating Through TCP/IP Over Telnet

Executing SCPI Commands Over Telnet

2. Enter the desired SCPI commands as follows:

- For a single SCPI command: Type or copy the desired command in the Telnet editor window, and then press ENTER to execute it.

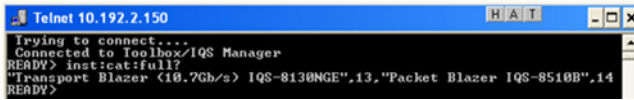

```
Telnet 10.192.2.150
Trying to connect...
Connected to Toolbox/IQS Manager
READY> inst:cat:full?
Transport Blazer (10.7Gb/s) IQS-8130NGE",13,"Packet Blazer IQS-8510B",14
READY>
```

- For multiple SCPI commands: Copy the desired commands from any script file, enclose them in a BEGIN and END block in the Telnet editor window, and then press ENTER. For more information, see *Internal Commands of the TCP/IP over Telnet Protocol* on page 477.

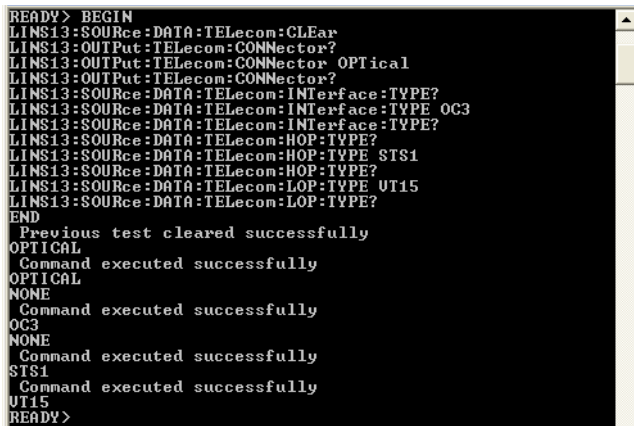

```
READY> BEGIN
LINS13:SOURce:DATA:TELEcom:CLEAr
LINS13:OUTPut:TELEcom:CONNector?
LINS13:OUTPut:TELEcom:CONNector OPTical
LINS13:OUTPut:TELEcom:CONNector?
LINS13:SOURce:DATA:TELEcom:INTerface:TYPE?
LINS13:SOURce:DATA:TELEcom:INTerface:TYPE OC3
LINS13:SOURce:DATA:TELEcom:INTerface:TYPE?
LINS13:SOURce:DATA:TELEcom:HOP:TYPE?
LINS13:SOURce:DATA:TELEcom:HOP:TYPE STS1
LINS13:SOURce:DATA:TELEcom:HOP:TYPE?
LINS13:SOURce:DATA:TELEcom:LOP:TYPE UT15
LINS13:SOURce:DATA:TELEcom:LOP:TYPE?
END
Previous test cleared successfully
OPTICAL
Command executed successfully
OPTICAL
NONE
Command executed successfully
OC3
NONE
Command executed successfully
STS1
Command executed successfully
UT15
READY>
```

3. Click  to close the session.

To execute SCPI commands over Telnet from a remote Linux client:

1. Establish a connection to the Telnet service as follows:
 - 1a. From your computer, right-click on the desktop, and then click **Open Terminal**.

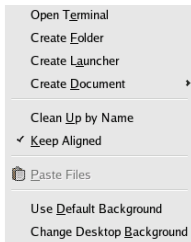

The command prompt is displayed in the Telnet editor window.

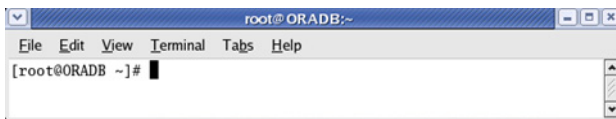

- 1b. Connect to the TCP/IP Telnet Service by typing the `OPEN <IP_ADDRESS_OF_TELNET_SERVER> <PORT>` command:

Example: `open 10.192.2.45 5024`

Note: *Port 5024 is designated for sending SCPI commands in the Telnet protocol.*

The connection is established when the message **Connected to Toolbox/IQS Manager** is displayed in the Telnet editor window.

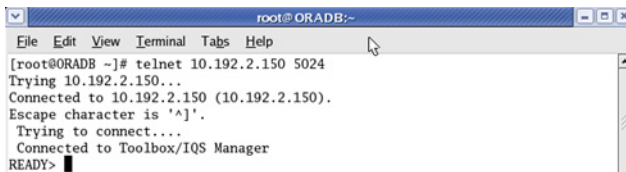

Communicating Through TCP/IP Over Telnet

Executing SCPI Commands Over Telnet

2. Enter the desired SCPI commands as follows:
 - For a single SCPI command: Type or copy the desired command in the Telnet editor window, and then press ENTER to execute it.

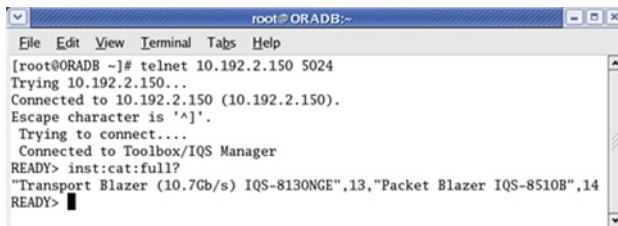

```
root@ORADB:~  
File Edit View Terminal Tabs Help  
[root@ORADB ~]# telnet 10.192.2.150 5024  
Trying 10.192.2.150...  
Connected to 10.192.2.150 (10.192.2.150).  
Escape character is '^]'.  
Trying to connect...  
Connected to Toolbox/IQS Manager  
READY> inst:cat:full?  
"Transport Blazer (10.7Gb/s) IQS-8130NGE",13,"Packet Blazer IQS-8510B",14  
READY> █
```

- For multiple SCPI commands: Copy the desired commands from any script file, enclose them in a BEGIN and END block in the Telnet editor window, and then press ENTER. **For more information, see *Internal Commands of the TCP/IP over Telnet Protocol* on page 477.**
3. Click  to close the session.

Accessing Modules

A session can directly access an instrument using valid LINS commands such as LINS10:SOURce:DATA:TELEcom:CLEar.

However, in a context of multiple sessions, additional commands are available to inform other sessions that an instrument is currently in use.

When a session uses the CONNECT LINS command, another session using the same CONNECT LINS command will receive an error indicating that the instrument is already in use.

For example:

- SESSION 1 sends this command:
CONNECT LINS10

The command returns...OK

- SESSION 2 sends this command:
CONNECT LINS10

The commands returns...Error

At this moment, SESSION 2 knows that LINS10 is already in use by another session.

Note: *Both sessions must use these commands to ensure that they receive accurate information.*

Communicating Through TCP/IP Over Telnet

Accessing Modules

A module is released by one of the following actions:

- Executing the `CLOSE LINS` command to disconnect the link with the module. For more information, see *CLOSE LINS* on page 481.
- Executing the `CLOSE` command to end the current session once the execution of all the desired commands has been completed. For more information, see *CLOSE* on page 480.
- Closing the current session by clicking the Close button on the Telnet editor windows' title bar.
- Shutting down and restarting the client computer.
- A network interruption.

A module can also be released when you terminate the communication by using the `KILL LINS` command. For more information, see *KILL LINS* on page 485.

Internal Commands of the TCP/IP over Telnet Protocol

The internal commands allow you to perform certain actions such as send SCPI commands as a script instead of one by one, force the disconnection of an active session, view the status of modules and of connected clients, etc. The internal commands are not case-sensitive.

ABORT BEGIN

Description The ABORT BEGIN command prevents the execution of the SCPI commands that are enclosed in a BEGIN and END block, and returns to the READY> prompt in the Telnet editor window.

Syntax ABORT BEGIN

Examples

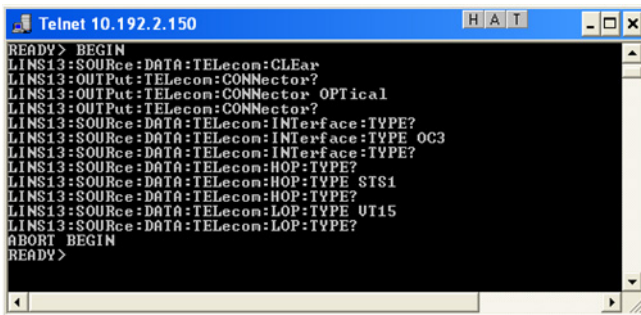

```
Telnet 10.192.2.150  H|A|T  - _ x
READY> BEGIN
LINS13:SOURce:DATA:TELEcon:CLEAr
LINS13:OUTPut:TELEcon:CONNector?
LINS13:OUTPut:TELEcon:CONNector? Optical
LINS13:OUTPut:TELEcon:CONNector?
LINS13:SOURce:DATA:TELEcon:INTErface:TYPE?
LINS13:SOURce:DATA:TELEcon:INTErface:TYPE OC3
LINS13:SOURce:DATA:TELEcon:INTErface:TYPE?
LINS13:SOURce:DATA:TELEcon:HOP:TYPE?
LINS13:SOURce:DATA:TELEcon:HOP:TYPE STS1
LINS13:SOURce:DATA:TELEcon:HOP:TYPE?
LINS13:SOURce:DATA:TELEcon:LOP:TYPE UT15
LINS13:SOURce:DATA:TELEcon:LOP:TYPE?
ABORT BEGIN
READY>
```

Communicating Through TCP/IP Over Telnet

Internal Commands of the TCP/IP over Telnet Protocol

BEGIN and END

Description	The BEGIN and END commands allow to define blocks of SCPI commands (script) in a Telnet editor window. The SCPI commands enclosed in BEGIN and END blocks will be executed in batch.
Syntax	BEGIN <SCPI_command> <SCPI_command> ... END

BEGIN and END

Examples

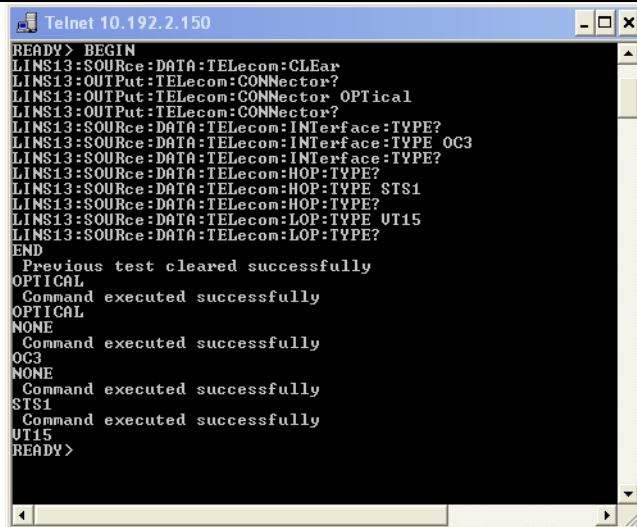

```
Telnet 10.192.2.150
READY> BEGIN
LINS13:SOURCE:DATA:TELECOM:CLear
LINS13:OUTPut:TELECOM:CONNector?
LINS13:OUTPut:TELECOM:CONNector OPTical
LINS13:OUTPut:TELECOM:CONNector?
LINS13:SOURCE:DATA:TELECOM:INterface:TYPE?
LINS13:SOURCE:DATA:TELECOM:INterface:TYPE OC3
LINS13:SOURCE:DATA:TELECOM:INterface:TYPE?
LINS13:SOURCE:DATA:TELECOM:HOP:TYPE?
LINS13:SOURCE:DATA:TELECOM:HOP:TYPE STS1
LINS13:SOURCE:DATA:TELECOM:HOP:TYPE?
LINS13:SOURCE:DATA:TELECOM:LOP:TYPE UT15
LINS13:SOURCE:DATA:TELECOM:LOP:TYPE?
END
Previous test cleared successfully
OPTICAL
Command executed successfully
OPTICAL
NONE
Command executed successfully
OC3
NONE
Command executed successfully
STS1
Command executed successfully
UT15
READY>
```

Notes

- To execute a single command, simply type or paste the command in the Telnet editor window.
- You cannot enclose internal commands in a BEGIN and END block, except the ABORT BEGIN command.

Communicating Through TCP/IP Over Telnet

Internal Commands of the TCP/IP over Telnet Protocol

CLOSE

Description The CLOSE command terminates the current Telnet session.

Syntax CLOSE

Examples

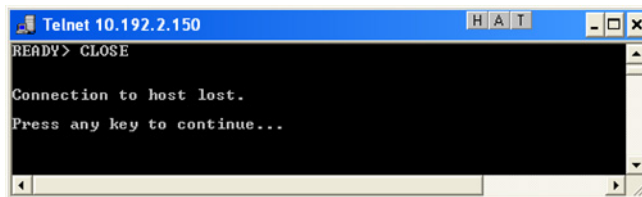

```
Telnet 10.192.2.150 H A T
READY> CLOSE
Connection to host lost.
Press any key to continue...
```

CLOSE LINS

Description	This command allows to close any active connections that have been previously established with the CONNECT LINS command (see <i>CONNECT LINS</i> on page 483). You can send this command to close all client's connections to any module, including the current connection.
Syntax	<p>The syntax of the command vary according to the type of platform you are using.</p> <ul style="list-style-type: none">➤ For IQS-600 and FTB-500: CLOSE LINS<Unit_Number> <Slot_Number> You must specify the unit number and the slot number identifying the module for which you want to close the connections.➤ For LTB-1, LTB-8, FTB-2, FTB-2 Pro, and FTB-4 Pro: CLOSE LINS<Logical_Instrument_Number> You must specify the logical instrument number corresponding to the module for which you want to close the connections. This number is configurable from the Remote Control Configuration application.

Communicating Through TCP/IP Over Telnet

Internal Commands of the TCP/IP over Telnet Protocol

CLOSE LINS

Examples

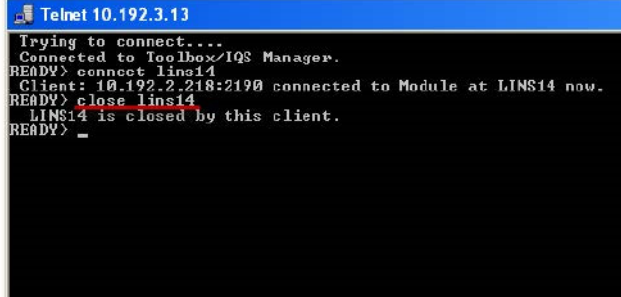

```
Telnet 10.192.3.13
Trying to connect...
Connected to Toolbox/IQS Manager.
READY> connect lins14
Client: 10.192.2.218:2190 connected to Module at LINS14 now.
READY> close lins14
LINS14 is closed by this client.
READY> _
```

Notes

- If the command is not executed successfully, a possible reason could be that the provided information does not correspond to a valid LINS.
- On all platforms except IQS-600 and FTB-500, CLOSE LINS does not prevent another session from accessing the instrument using a direct LINS command.

CONNECT LINS

Description	This command allows to inform other sessions that you are connected to one or more instruments.
Syntax	<p>The syntax of the command vary according to the type of platform you are using.</p> <ul style="list-style-type: none">▶ For IQS-600 and FTB-500: CONNECT LINS<Unit_Number><Slot_Number> You must specify the unit number and the slot number identifying the module to which the session will connect.▶ For LTB-1, LTB-8, FTB-2, FTB-2 Pro, and FTB-4 Pro: CONNECT LINS<Logical_Instrument_Number> You must specify the logical instrument number corresponding to the module to which the session will connect. This number is configurable from the Remote Control Configuration application.

Communicating Through TCP/IP Over Telnet

Internal Commands of the TCP/IP over Telnet Protocol

CONNECT LINS

Examples



```
Telnet 10.192.3.13
Trying to connect...
Connected to Toolbox/IQS Manager.
READY> connect lins14
Client: 10.192.2.218:2190 connected to Module at LINS14 now.
READY> _
```

Notes

- On all platforms except IQS-600 and FTB-500, for compatibility reasons, you can connect to a module with a valid instrument command and a valid LINS (such as Lins10:SOURce:DATA:TELEcom:CLEAR). However, there will be no way for other sessions to know that you are connected to this instrument.
- If the command is not executed successfully, the possible reasons could be:
 - The module is already connected to a different client session.
 - The provided information does not correspond to a valid LINS.

KILL LINS

Description This command allows any user to terminate the session that contains the specified connection (LINS), if this connection has been previously established with the CONNECT LINS command (see *CONNECT LINS* on page 483). This means that it will terminate all active connections that belong to a session if these connections have been previously established with CONNECT LINS.

Syntax The syntax of the command vary according to the type of platform you are using.

- For IQS-600 and FTB-500:
KILL LINS<Unit_Number> <Slot_Number>
You must specify the unit number and the slot number identifying the module for which you want to terminate the session.
- For LTB-1, LTB-8, FTB-2, FTB-2 Pro, and FTB-4 Pro:
KILL LINS<Logical_Instrument_Number>
You must specify the logical instrument number corresponding to the module for which you want to terminate the session. This number is configurable from the Remote Control Configuration application.

Examples

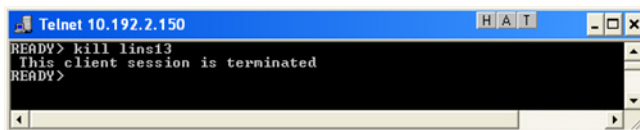

```
Telnet 10.192.2.150  H A T  _ _ x
READY> kill lins13
This client session is terminated
READY>
```

Communicating Through TCP/IP Over Telnet

Internal Commands of the TCP/IP over Telnet Protocol

KILL LINS

Notes

- To know the status of the modules before terminating connections using the KILL LINS command, you can first enter the STATUS CLIENT command. For more information, see *STATUS CLIENT* on page 487.

In the example below, two modules are connected: LINS13 and LINS10.

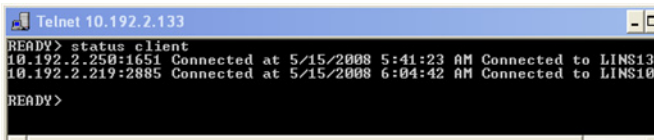

```
Telnet 10.192.2.133
READY> status client
10.192.2.250:1651 Connected at 5/15/2008 5:41:23 AM Connected to LINS13
10.192.2.219:2885 Connected at 5/15/2008 6:04:42 AM Connected to LINS10
READY>
```

- To disconnect the LINS10 module used by another session, enter the *kill lins10* command. A confirmation message is displayed once the module is disconnected.

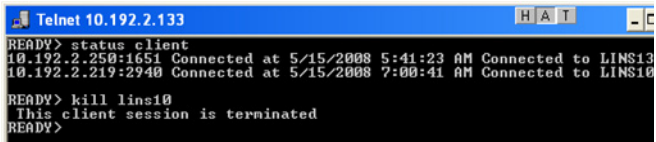

```
Telnet 10.192.2.133
READY> status client
10.192.2.250:1651 Connected at 5/15/2008 5:41:23 AM Connected to LINS13
10.192.2.219:2940 Connected at 5/15/2008 7:00:41 AM Connected to LINS10
READY> kill lins10
This client session is terminated
READY>
```

- Enter again the STATUS CLIENT command to confirm the termination of the module (LINS10 in our example). Only the information of the remaining connected client is displayed.

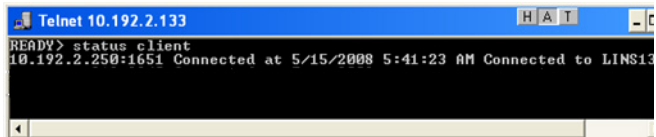

```
Telnet 10.192.2.133
READY> status client
10.192.2.250:1651 Connected at 5/15/2008 5:41:23 AM Connected to LINS13
READY>
```

STATUS CLIENT

Description This command lists out all clients with their connection time and modules.

Syntax STATUS CLIENT

Examples

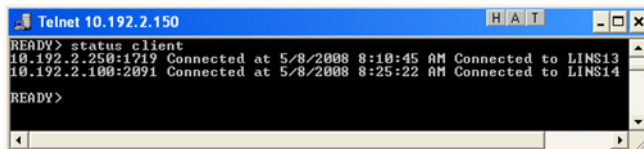

```
Telnet 10.192.2.150 H A I T
READY> status client
10.192.2.250:1719 Connected at 5/8/2008 8:10:45 AM Connected to LINS13
10.192.2.100:2091 Connected at 5/8/2008 8:25:22 AM Connected to LINS14
READY>
```

STATUS CONNECTION

Description This command lists out all the connections with their *Idle* or *Active* status.

Syntax STATUS CONNECTION

Examples

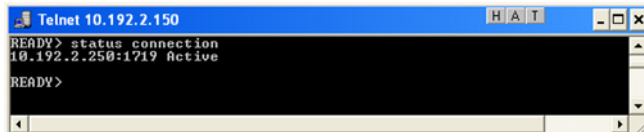

```
Telnet 10.192.2.150 H A I T
READY> status connection
10.192.2.250:1719 Active
READY>
```

Notes By default, any connection that is idle for 5 minutes or more is identified as *Idle*.

Communicating Through TCP/IP Over Telnet

Internal Commands of the TCP/IP over Telnet Protocol

STATUS MODULE

Description This command lists out all the modules with the slot numbers where they are located (IQS-600 and FTB-500), or with their LINS (all other platforms).

Syntax STATUS MODULE

Examples

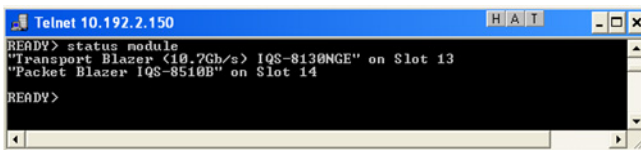

```
Telnet 10.192.2.150
READY> status module
"Transport Blazer <10.7Gb/s> IQS-8130NGE" on Slot 13
"Packet Blazer IQS-8510B" on Slot 14
READY>
```

WHO M I?

Description This command retrieves the IP address and the communication port of the current session.

Syntax WHO M I?

Examples

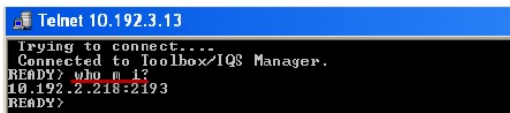

```
Telnet 10.192.3.13
Trying to connect...
Connected to Toolbox/IQS Manager.
READY> who m i?
10.192.2.218:2193
READY>
```

Index

2.0 USB port..... 4, 5, 8
3.0 USB port..... 4, 5

A

AC power
 adapter..... 17
 connector 6
 three-wire cord..... 17
AC requirements 31, 32
accessing
 Internet with a USB modem 149
 online help..... 367
 power meter and VFL 165
 ToolBox X 65
activating on-screen keyboard 67
ActiveX
 control..... 234
 linking units..... 235
 selecting 240
adapter 29
adjusting
 brightness..... 83
 date, time and time zone..... 119
 right-click..... 94
 volume..... 85
after-sales service 368
amber LED..... 13
angled brackets..... 282
anti-theft mechanism..... 6, 7, 78
antivirus software..... 77
appearance, date and time 117
applications
 installing..... 71
 module, starting 66
 ToolBox X, starting 163
ASCII format..... 237

automatic
 fan speed 19
 Windows updates 316
automation..... 233, 239

B

backlight, setting..... 83
battery
 error..... 13
 general information 17
 LED 3
 level 295
 maintenance recommendations..... 295
 replacing or removing..... 303
 thresholds, setting 298
 type allowed 304
bay
 module 4, 5
 power meter 311
black LED..... 13
blinking LED 13
Bluetooth®
 data transfer 171
 devices 81
 frequency band data..... x
 limitations..... 171
 option 20
boot, first 63
braces 282
brackets
 angled..... 282
 square..... 281
brightness, adjusting 83, 142
browsing Web 148
buttons..... 16

Index

C

- calibrating the touchscreen 91
- capacitors 28
- capacity, storage 170
- capturing images 3, 147
- carry strap, installing 39
- caution
 - of personal hazard 22
 - of product hazard 22
- certification information viii
- changing
 - batteries 303
 - communication settings 238
 - date and time 119
 - language 106
 - low-battery thresholds 298
- charge icon 295
- charger 29
- Charm bar, display 68
- choosing
 - language 106
 - power management option 122
 - time zone 119
- cleaning
 - detector ports 292
 - front panel 291
 - touchscreen 294
 - VFL connectors 293
- cleanup disk 187
- close window 68
- codes, error 286
- colon 282
- colors, LEDs 13
- COM, local control 234
- COM/DCOM
 - events 468
 - properties 461
- comma 283
- commands
 - IEEE 488.2 404
 - SCPI 280
 - specific 425
 - TCP/IP 477–486
- communication
 - ActiveX 234
 - changing settings 238
 - Ethernet TCP/IP 233, 234
 - RS-232 233, 234
 - TCP/IP 469
 - TCP/IP over Telnet 234
- configuring
 - power management options 122
 - unit 63
- connecting
 - screen 8
 - to a VPN 196
 - unit to wireless network 178
 - USB device 79
- connector cleaner 293
- ConnectorMax2 167
- consulting PDF files 146
- control
 - ActiveX 234
 - Ethernet TCP/IP 233, 234
 - module 233
 - remote 233
 - RS-232 234
 - TCP/IP over Telnet 234
- conventions, programming 280, 283, 285
- conventions, safety 22
- coordinates, GPS 137, 151
- copying
 - commands into text document 288, 290
 - files and folders 170
- creating PDF files 145
- current modules view 66
- current, electrical 31
- customer service 379

- D**
- data
 - transfer..... 171
 - types..... 381
 - data input
 - IEEE 488.2 382
 - SCPI 401
 - data output IEEE 488.2
 - special 394, 402
 - standard 391
 - date and time
 - adjusting 119
 - formats..... 117
 - DCOM
 - configuring computers..... 243
 - technology..... 234
 - deactivating Wi-Fi 191
 - defining battery thresholds 298
 - deleting
 - files and folders 170
 - unused system files..... 187
 - description, function buttons..... 16
 - detector port, cleaning..... 292
 - digit 281
 - dirty fibers..... 167
 - disconnecting unit..... 27
 - Disk Cleanup 187
 - disk space, free..... 170
 - display Charm bar 68
 - DisplayPort interface 8
 - documentation..... 367
 - documents, printing..... 145
 - dongle
 - GPS..... 151
 - mobile broadband USB..... 149
 - down, swipe..... 68
- E**
- earth ground terminal..... 6, 7
 - enabling wireless device..... 191
 - equipment returns 379
- F**
- error messages in remote control 286
 - Ethernet port 4, 5
 - Ethernet TCP/IP
 - control 233, 234
 - port..... 235
 - exiting ToolBox X..... 65
 - Explorer, Internet..... 148
 - exporting results..... 232
 - external power supply 29
- G**
- fan speed..... 19
 - fiber probe 167
 - file
 - format..... 232
 - name..... 232
 - size limit, Bluetooth® 171
 - files and folders, managing 170
 - first startup..... 63
 - flashing LED..... 13
 - free disk space..... 170
 - freeing space on disk..... 187
 - frequency, Bluetooth® and Wi-Fi x
 - front panel, cleaning 291
 - function buttons description 16
 - fuse
 - replacement..... 28, 321
 - type 321
- G**
- geolocation information..... 137
 - gestures, touchscreen..... 68
 - GPS coordinates 137, 151
 - green LED 13
 - grounding stud 6, 7, 33

Index

H

hazard, laser radiation.....	26
headset	
Bluetooth®.....	81
port.....	8
volume.....	85
help, online.....	367
hibernation mode.....	57
host ports, USB.....	4, 5
hour, setting.....	119

I

icon, battery.....	295
identification label.....	368
identifying defects on fibers.....	167
IEEE 488.2 commands.....	404
indoor use.....	28
inlets.....	27
input	
current.....	31
IEEE 488.2 data types.....	382
SCPI data types.....	401
inserting	
batteries.....	303
module.....	4, 5, 6, 7, 45
inspection probe.....	167
installing	
software.....	71
third-party software.....	77
unit.....	28
VPN clients.....	196
instrument control settings.....	238
interface, changing language.....	106
Internet connection.....	148, 149

K

Kensington lock.....	6, 7, 78
keyboard	
button.....	16
on-screen.....	67
USB.....	79
keywords, SCPI.....	282

L

label, identification.....	368
LAN network.....	234
language, selecting.....	106
laser safety information.....	26
launching probe application.....	167
LED	
battery.....	3
indicators.....	13
left, swipe.....	68
level, battery.....	295
linking units via Bluetooth®.....	81
list separator.....	282
local control.....	234
localizing your unit.....	137, 151
lock mechanism.....	78
longitude and latitude.....	137, 151
low-battery thresholds, setting.....	298

M

maintenance	
battery.....	295
detector ports.....	292
front panel.....	291
general information.....	291
touchscreen.....	294
managing files and folders.....	170
mandatory commands.....	404
manuals.....	367

- maximum
 - distance, Bluetooth®..... 171
 - file size 171
 - input current 31
 - mechanical connector cleaning 293
 - microphone
 - port 8
 - volume..... 85
 - mnemonic, definition..... 282
 - mobile broadband USB modem, using..... 149
 - modifying power plans 122
 - module
 - adapter..... 4, 5
 - controlling..... 233
 - insertion 45
 - removal 45
 - slot 4, 5
 - monitor, external 8
 - monitoring remote commands 287
 - mouse
 - Bluetooth®..... 81
 - USB..... 79
 - moving files and folders..... 170
 - multiple capabilities 281
- N**
- navigating the Internet 148
 - network, LAN/WAN 4, 5, 234
- O**
- off LED 13
 - on/off button 3
 - online help 367
 - on-screen keyboard..... 3, 67
 - opening user guides..... 146
 - operating system..... 68
 - operation language..... 106
 - options
 - Bluetooth®..... 81, 171
 - GPS..... 151
 - power meter and VFL 4, 5, 165
 - shoulder strap..... 39
 - software..... 20, 74
 - ToolBox X..... 132
 - Wi-Fi 178
 - orange LED 13
 - output IEEE 488.2
 - special 394, 402
 - standard 391
- P**
- PACKed format 237
 - parameters
 - for ping..... 227
 - for trace route..... 230
 - PDF files
 - generating 145
 - viewing 146
 - PDF reader..... 146
 - physical keyboard 79
 - ping, performing a test 227
 - pipe character..... 282
 - platform commands..... 425
 - port
 - Ethernet..... 4, 5, 235
 - USB 4, 5, 8
 - power
 - cable 27
 - plug 27
 - sources..... 17, 31
 - supply 29
 - power management, configuring..... 122
 - power meter
 - accessing..... 165
 - location..... 4, 5
 - power plans, selecting and modifying..... 122
 - press and hold 70
 - printer, Bluetooth® 81
 - printing documents..... 145
 - product
 - identification label 368
 - specifications 21

Index

profiles, Bluetooth® 81
program switcher button 16
programmable instruments,
 standards 233, 280
protective cap 292
purchased options 74

R

radiation hazard, laser 26
reading PDF files 146
real keyboard 79
receiving data
 via Bluetooth® 171
 with Ethernet port 235
red LED 13
regional and language settings 63
register
 diagram 278, 279
 ESE 276
 ESR 276
 SRE 276
 STB 276
remaining disk space 170
remote control
 ActiveX (DCOM) 234, 235
 configuring 239, 243
 description of commands 280
 error messages 286
 methods 233
 monitoring 287
 RS-232 233, 234
 TCP/IP 234, 469, 477–486
removing
 batteries 303
 module 45
 shoulder strap 39
repairing unit 28
replacing fuses 321
retrieving position of unit 137, 151
return merchandise authorization (RMA) .. 379
right, swipe 68

right-clicking with touchscreen 70, 94
RJ-45 port 4, 5
RS-232
 communication 233
 control 234
 selecting 240
rules
 programming 285
 syntax 283
 syntax conventions 280

S

safety
 caution 22
 conventions 22
 information 26
 power cable 27
 warning 22
saving test results 232
SCPI
 commands 280
 data types 401
 guidelines 233, 280
screen
 captures 3, 16, 147
 external 8
securing unit 78
selecting
 language 106
 startup applications 102
 time zone 119
semicolon 283
sending data
 via Bluetooth® 171
 with Ethernet port 235
separator 282, 283
service and repairs 379
service centers 380
service request enable register (SRE) 276

-
- setting
 - date and time 117, 119
 - instrument control utility 238
 - low-battery thresholds 298
 - sharing data 81
 - shipping to EXFO 379
 - short and long formats, date 117
 - shoulder strap, installing 39
 - show Charm bar 68
 - shutdown modes 57
 - sleep mode 57
 - software
 - accessing 65
 - exiting 65
 - installing 71
 - options 20, 74
 - upgrading 71
 - space 281
 - speaker volume 85, 142
 - specific commands 425
 - specifications, product 21
 - speed of right-click 94
 - square brackets 281
 - stand for unit 35
 - standard event status
 - enable register (ESE) 276
 - register (ESR) 276
 - standard status data structure
 - diagram 278, 279
 - general 276
 - starting
 - applications 66, 163
 - probe application 167
 - ToolBox X 65
 - Wi-Fi module 191
 - startup, selecting applications for 102
 - status byte register (STB) 276
 - stopping Wi-Fi device 191
 - storage requirements 291
 - stud, grounding 33
 - stylus 8
 - support for unit 35
 - surfing the Internet 148
 - swipe 68
 - symbols, safety 22
 - syntax
 - rules 280, 283
 - SCPI 280
 - symbols 281
- T**
- TCP/IP
 - commands 477–486
 - configuring parameters 241
 - connecting to Linux 473
 - connecting to Windows 469
 - control 233, 234
 - introduction 469
 - release examples 475
 - selecting 240
 - technical specifications 21
 - technical support 368
 - telecom ground 6, 7
 - temperature for storage 291
 - third-party software 77
 - time zone, selecting 119
 - ToolBox X
 - applications 163
 - language 106
 - options 132
 - touchscreen
 - calibrating 91
 - cleaning 294
 - gestures 68
 - location 3
 - right-clicking 70
 - stylus 8
 - trace route, performing a test 230
 - transferring data via Bluetooth® 171
 - transportation requirements 291, 376
 - turning off
 - unit 57
 - Wi-Fi 191

Index

turning on unit..... 57
type of fuses 28
types, data 381

U

unit
back support 35
disconnecting 27
first configuration..... 63
installing..... 28
localizing 137, 151
repairing..... 28
ventilation 28
updating
applications 71
Windows applications 316
USB
device 79
ports..... 4, 5, 8
user guides..... 367
using
a mobile broadband USB modem..... 149
Bluetooth® devices 81

V

ventilation 28
vertical bar 282
VFL
accessing 165
cleaning..... 293
option..... 4, 5
viewing
current modules 66
PDF files..... 146
virtual private network (VPN) 196

W

WAN network..... 234
warning, low battery 298
warranty
certification..... 378
exclusions 378
general..... 377
liability..... 378
null and void..... 377
weak battery 298
Web browser 148
white space 281
Wi-Fi
connecting 178
frequency band data..... x
option 20
Windows
8.1 Pro version 68
Embedded 8 Standard version 68
update of applications 316
Windows Mobility Center 142
Windows.old folder..... 187
wireless
connection 149
internal device 191
mouse and keyboard 81
network 178
printer..... 81
wizard, configuration 63
working with Windows 68
wsp 281

Y

yellow LED 13

CHINESE REGULATION ON RESTRICTION OF HAZARDOUS SUBSTANCES (RoHS)

中国关于有害物质限制的规定

NAMES AND CONTENTS OF THE TOXIC OR HAZARDOUS SUBSTANCES OR ELEMENTS
CONTAINED IN THIS EXFO PRODUCT

包含在本 EXFO 产品中的有毒有害物质或元素的名称及含量

Part Name 部件名称	Lead 铅 (Pb)	Mercury 汞 (Hg)	Cadmium 镉 (Cd)	Hexavalent Chromium 六价铬 (Cr(VI))	Polybrominated biphenyls 多溴联苯 (PBB)	Polybrominated diphenyl ethers 多溴二苯醚 (PBDE)
Enclosure 外壳	O	O	O	O	O	O
Electronic and electrical sub-assembly 电子和电气组件	X	O	X	O	X	X
Optical sub-assembly ^a 光学组件 ^a	X	O	O	O	O	O
Mechanical sub-assembly ^a 机械组件 ^a	O	O	O	O	O	O

Note:

注:

This table is prepared in accordance with the provisions of SJ/T 11364.

本表依据 SJ/T 11364 的规定编制。

O: Indicates that said hazardous substance contained in all of the homogeneous materials for this part is below the limit requirement of GB/T 26572.

O: 表示该有害物质在该部件所有均质材料中的含量均在 GB/T 26572 标准规定的限量要求以下。

X: indicates that said hazardous substance contained in at least one of the homogeneous materials used for this part is above the limit requirement of GB/T 26572. Due to the limitations in current technologies, parts with the "X" mark cannot eliminate hazardous substances.



X: 表示该有害物质至少在该部件的某一均质材料中的含量超出 GB/T 26572 标准规定的限量要求。

标记 "X" 的部件, 皆因全球技术发展水平限制而无法实现有害物质的替代。

a. If applicable.

如果适用。

MARKING REQUIREMENTS
标注要求

Product 产品	Environmental protection use period (years) 环境保护使用期限 (年)	Logo 标志
This EXFO product 本 EXFO 产品	10	
Battery ^a 电池	5	

a. If applicable.
如果适用。

P/N: 1072146

www.EXFO.com · info@exfo.com

CORPORATE HEADQUARTERS	400 Godin Avenue	Quebec (Quebec) G1M 2K2 CANADA Tel.: 1 418 683-0211 · Fax: 1 418 683-2170
EXFO AMERICA	3400 Waterview Parkway Suite 100	Richardson, TX 75080 USA Tel.: 1 972-761-9271 · Fax: 1 972-761-9067
EXFO EUROPE	Winchester House, School Lane	Chandlers Ford, Hampshire S053 4DG ENGLAND Tel.: +44 2380 246 800 · Fax: +44 2380 246 801
EXFO ASIA-PACIFIC	62 Ubi Road 1, #09-01/02 Oxley Bizhub 2	SINGAPORE 408734 Tel.: +65 6333 8241 · Fax: +65 6333 8242
EXFO CHINA	Beijing Global Trade Center, Tower C, Room 1207, 36 North Third Ring Road East, Dongcheng District	Beijing 100013 P. R. CHINA Tel.: +86 (10) 5825 7755 · Fax: +86 (10) 5825 7722
EXFO SERVICE ASSURANCE	250 Apollo Drive	Chelmsford MA, 01824 USA Tel.: 1 978 367-5600 · Fax: 1 978 367-5700
EXFO FINLAND	Elektroniikkatie 2	FI-90590 Oulu, FINLAND Tel.: +358 (0) 403 010 300 · Fax: +358 (0) 8 564 5203
TOLL-FREE	(USA and Canada)	1 800 663-3936

© 2017 EXFO Inc. All rights reserved.
Printed in Canada (2017-07)

